

Philosophy

One hundred years of fundamental technology, and the endless pursuit of new value.

Tsubakimoto Chain has worked tirelessly on improving chain performance since our founding in 1917. We were the first Japanese factory to be accredited by Japan Industrial Standards (JIS) for roller chain in 1953. We dubbed that roller chain our first generation chain, and every decade since we have made major leaps in performance up to the 2006 launch of our G7 Series, the world's highest quality roller chain. To celebrate our 100th anniversary, we will be launching our next generation G8 Series, the next evolution of our chain line.

History of RS Roller Chain

- 1917 • Founding
- 1953 • 612 Series JIS accredited
- 1964 • NA Series 2x kW ratings
- 1969 • 53 Series 15% higher tensile strength, global quality
- 1976 • 60 Series 7% higher tensile strength, 25% higher kW ratings, world's top quality
- 1985 • 70 Series 2x wear life, less initial elongation
- 1995 • 80 Series M-type connecting link provides 25% higher kW ratings, wear increased 30%
- 2006 • G7 Series 33% increased kW ratings, 2x wear life
- 2009 • G7-EX Series Expanded G7 size range
- 2016 • **G8 Series Centennial model**

As a manufacturing company, Tsubakimoto Chain continues to develop products that adapt to global needs with a century of chain manufacturing know-how and contribute to energy savings, labor savings, and better efficiency around the world.

Leonardo da Vinci, founder of the roller chain (1452-1519)

Leonardo da Vinci, the genius of the Renaissance, devised the prototype of a roller chain that today is widely used as a drive chain. His foresight and advanced ideas are revealed in his notebooks, which contain sketches of an object that looks remarkably like a modern chain. The photo shows a portrait of da Vinci, made entirely out of link plates, on display in the main lobby of Tsubakimoto Chain's Kyotanabe Plant.

The Start of a New Era



100th Anniversary Model
TSUBAKI G8 SERIES



The rebirth of the drive chain,
with improved quality and performance.

PRODUCT MAP

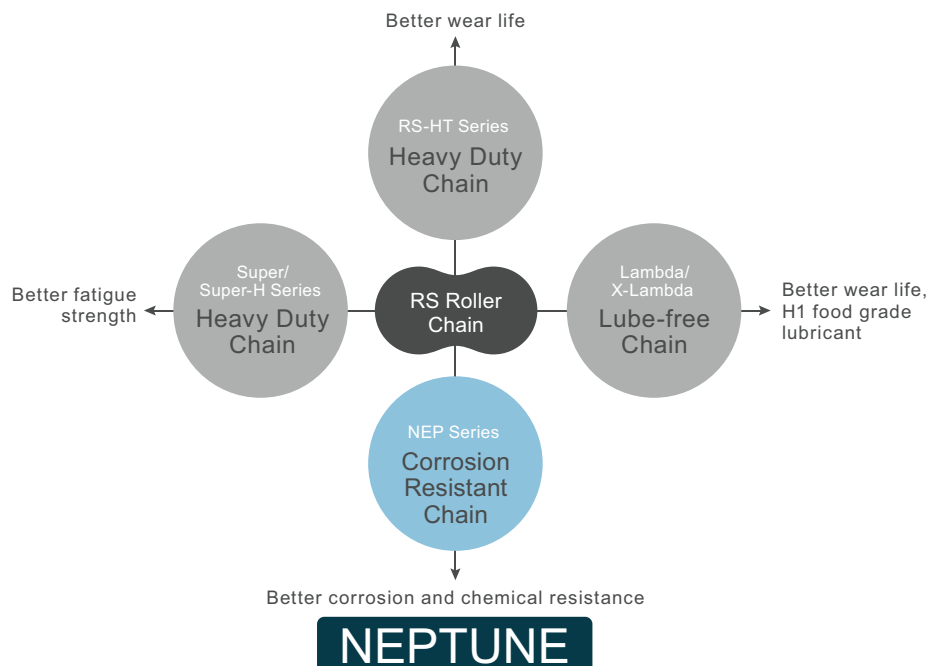

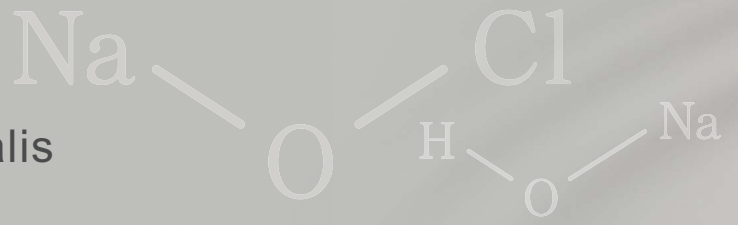

Tough against water and alkalis

Corrosion Resistant Chain

NEPTUNE

Previous Series

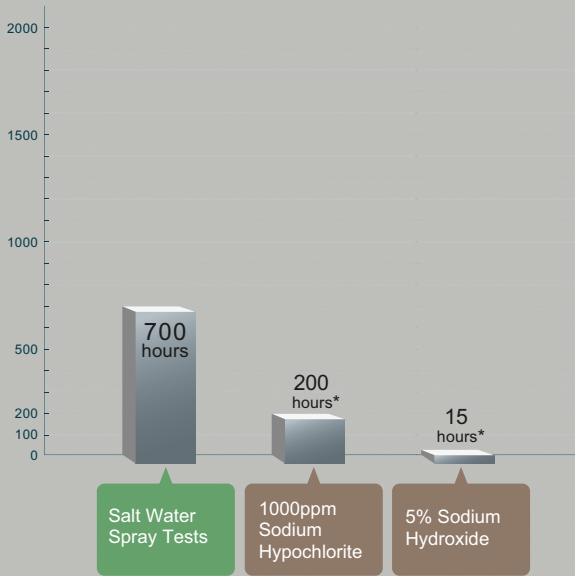



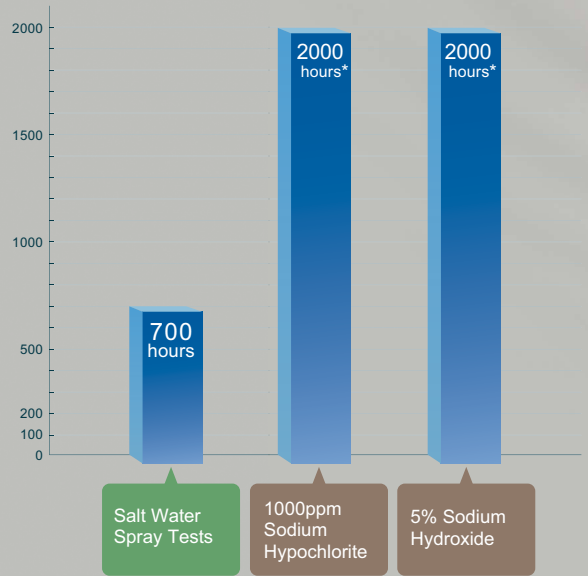



Neptune Series



*In-house test comparison

Superb Corrosion Resistance

| | Corrosion Resistance | Chemical Resistance | |
|-----------------|--|--|---|
| | Salt water spray tests* | 1000ppm sodium hypochlorite | 5% sodium hydroxide |
| Neptune | 700 hours  | 2000 hours  | 2000 hours  |
| Previous series | 700 hours  | 200 hours  | 15 hours  |

*Salt water spray tests in accordance with JIS-Z-2371.

New Surface Treatment Structure

Combines Tsubaki's uniquely developed special coating and special resin coating for superb corrosion (rust) and chemical resistance.

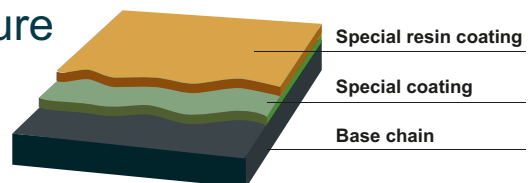

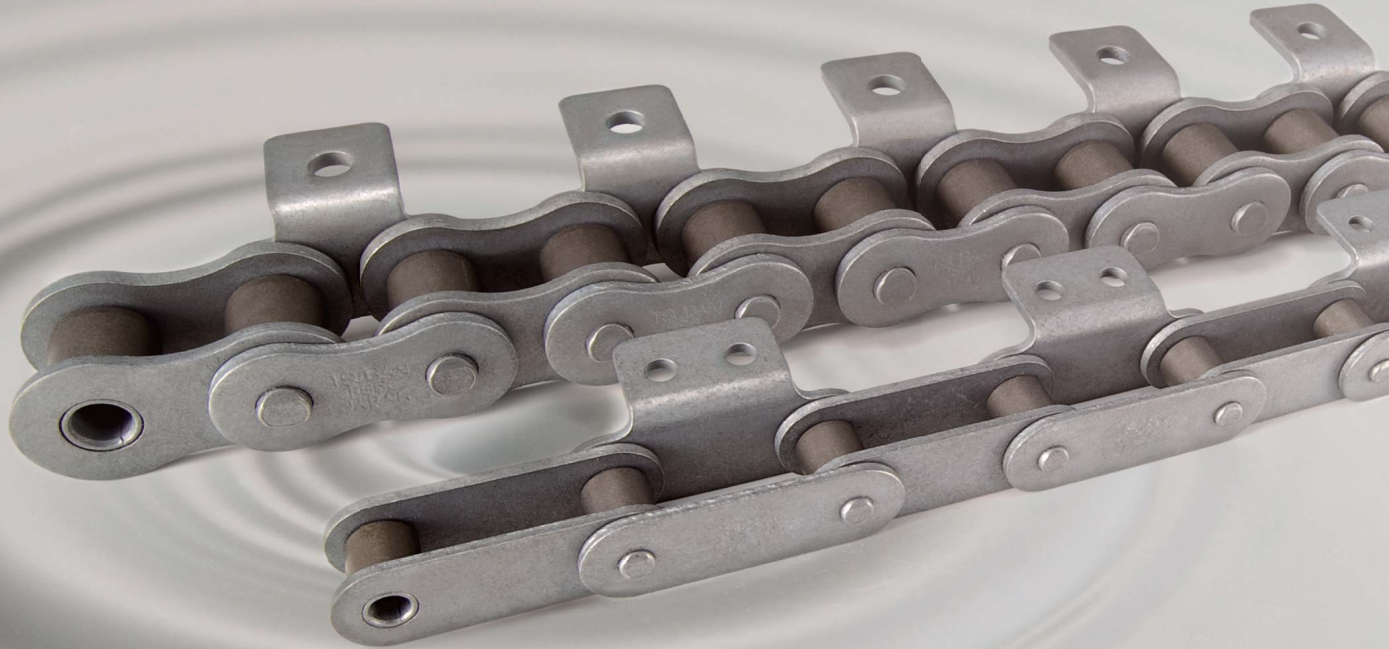

Lower Environmental Load

Neptune chains use no harmful hexavalent chromium in their corrosion resistant surface treatment, nor any other hazardous substances such as lead, cadmium, mercury, or arsenic. Neptune chains are RoHS compliant.



RoHS

RoHS is a directive issued by the European Union limiting the use of specified hazardous substances in electronics or electrical equipment.

No Strength Reduction

Uses a special treatment process that does not affect chain strength (part hardness). Neptune chains have the same tensile strength and allowable load as our standard roller chains.

Unit: kN{kgf}

| | Standard | Neptune Series | With Hexavalent Chromium | NP Series | SS Series Stainless Steel |
|-----------------------|----------------|----------------|--------------------------|----------------|---------------------------|
| Min. tensile strength | 17.7 {1800} | 17.7 {1800} | 16.6* {1690} | 17.7 {1800} | — |
| Max. allowable load | 3.63 {370} | 3.63 {370} | — | 3.04 {310} | 0.44 {45} |

Ref.: For RS40 size drive chain
*Ave. competitor tensile strength

And Much, Much More

Contact a Tsubaki representative regarding:

- Corrosion resistance to other chemicals besides alkalis.
- Surface treatments providing corrosion resistance for sizes not covered by Neptune. (Please note that these surface treatments will not have chemical resistance.)
(See pgs. 7 – 11 for Neptune chain sizes.)

Notes from the Developer



It was extremely difficult developing both the corrosion (rust) resistance and chemical resistance that Neptune chains required. Increasing the chemical resistance would decrease the corrosion resistance, and vice versa. I had to first select different materials and evaluate different combinations and surface treatment structures countless times. Then I evaluated 230 different combinations before finally developing a unique resin coating that gives Neptune Series vastly improved resistance to alkaline chemicals often used in food processing equipment and wash-down processes.

Applications

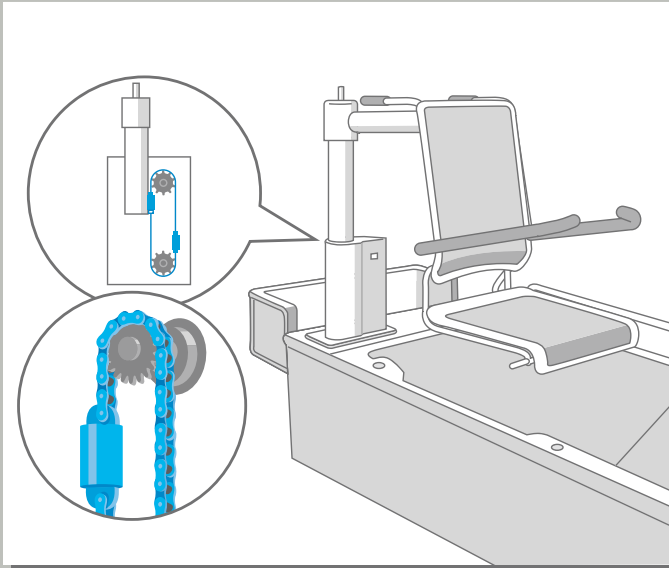

Nursing Bath

A stainless steel chain that would satisfy the required performance would be too big to fit in the space provided, so the user chose a Neptune chain, which has the same strength as steel chain. Slight amounts of detergent and other chemicals are used in the bath, so Neptune provided a much longer service life than steel chains.

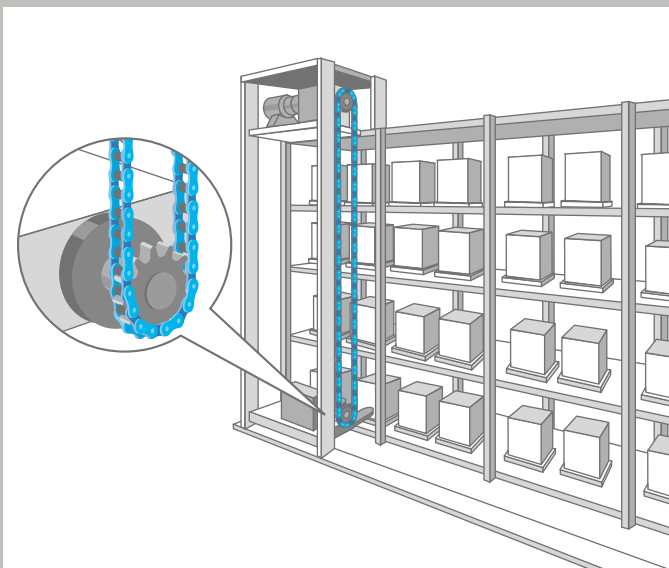

Automated Warehouse

Used on a stacker crane for mushroom cultivation in a high temperature, high humidity environment. Standard chain quickly corroded and suffered wear, while the required stainless steel chain would be too big, so the user chose Neptune.

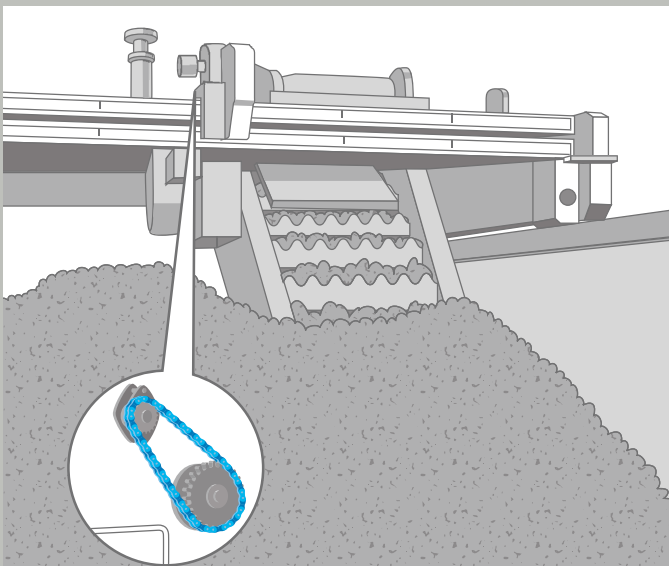

Raw Garbage Agitator

This equipment turns raw garbage into compost. The agitator, travel section, and drive of the equipment all use chain, but the corrosive environment (ammonia gas, etc.) degrades steel chain and shortens its service life. Switching to Neptune has doubled the wear life.

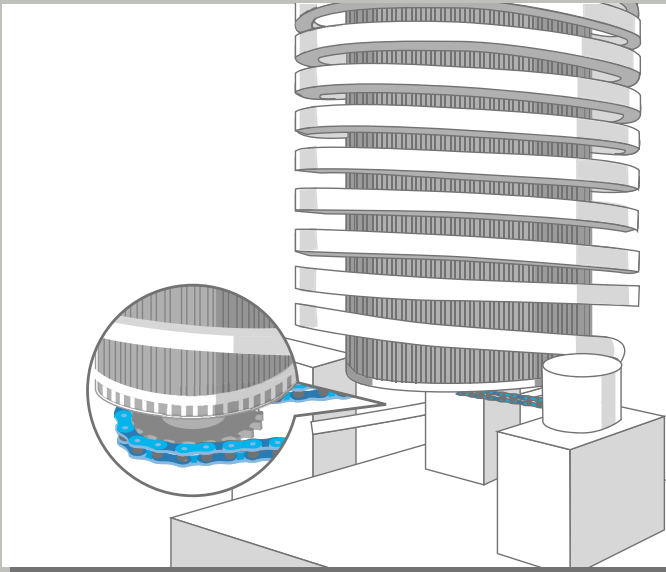

Spiral Conveyor

The center of the spiral conveyor rotates and lifts or lowers the conveyed goods. These conveyors are used in high and low temperatures, in contact with water or steam, in contact with chemicals, and many other environments. The drive requires a high tensile strength that stainless steel chains cannot provide. Neptune chain, with its corrosion and chemical resistance, solves this problem.

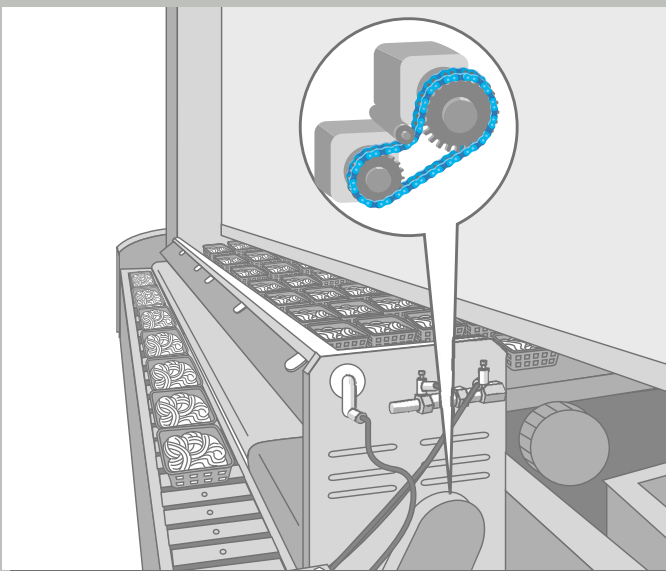

Frozen Noodle Conveyor

This conveyor conveys food, so there is always a wash-down when different products are conveyed or at the end of operations. Chemicals are used during this wash-down, so we proposed Neptune with its corrosion and chemical resistance. The chain in the drive section is covered, but cleaning water and chemicals sometimes splash on the cover – with Neptune, the user can use their chain worry free.

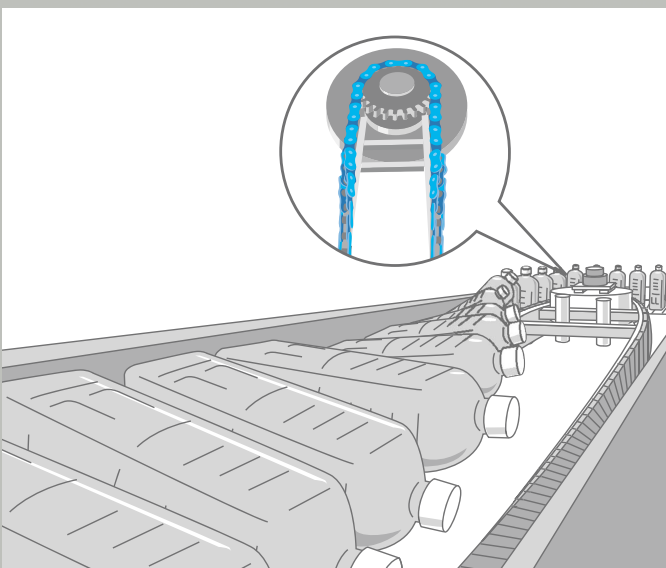

PET Bottle Sterilizer

Sterilizes PET bottles. The conveying area uses a special chain that is regularly in contact with water. The customer uses Neptune chain to prevent rusting.

Specifications and Drawings

Neptune Drive Chain

Chain Numbering Example

RS50-NEP-1

Chain no.

Neptune code

No. of strands

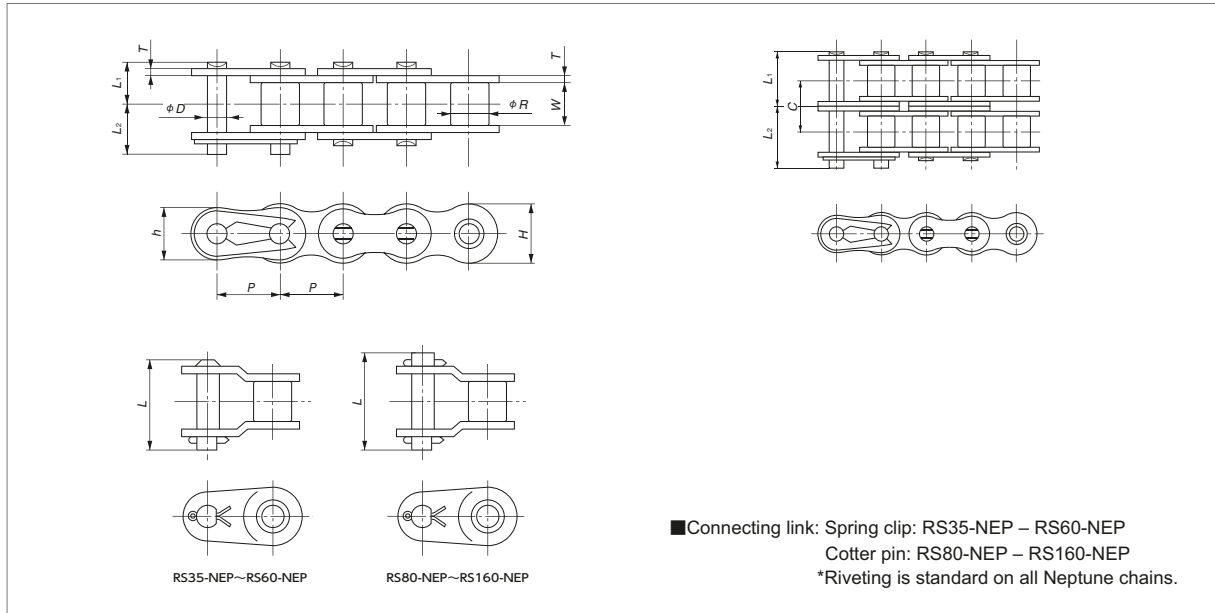

| TSUBAKI Chain Number | Pitch <i>P</i> | Roller Dia. (Bushing Dia.) <i>R</i> | Inner Width of Inner Link <i>W</i> | Plate | | | Pin | | | | | Transverse Pitch <i>C</i> |
|----------------------|-------------------|---|--|-----------------------|--------------------|--------------------|----------------------|---|-----------------------|-----------------------|-------------------------------|---------------------------------|
| | | | | Thickness <i>T</i> | Height <i>H</i> | Height <i>h</i> | Diameter <i>D</i> | <i>L</i> ₁ + <i>L</i> ₂ | <i>L</i> ₁ | <i>L</i> ₂ | Offset Pin Length <i>L</i> | |
| RS35-NEP-1 | 9.525 | (5.08) | 4.78 | 1.25 | 9.0 | 7.8 | 3.59 | 12.7 | 5.85 | 6.85 | 13.5 | - |
| RS40-NEP-1 | 12.70 | 7.92 | 7.95 | 1.5 | 12.0 | 10.4 | 3.97 | 18.2 | 8.25 | 9.95 | 18.2 | - |
| RS40-NEP-2 | | | | | | | | 32.6 | 15.45 | 17.15 | 33.5 | 14.4 |
| RS50-NEP-1 | 15.875 | 10.16 | 9.53 | 2.0 | 15.0 | 13.0 | 5.09 | 22.3 | 10.3 | 12.0 | 22.6 | - |
| RS50-NEP-2 | | | | | | | | 40.5 | 19.35 | 21.15 | 41.8 | 18.1 |
| RS60-NEP-1 | 19.05 | 11.91 | 12.70 | 2.4 | 18.1 | 15.6 | 5.96 | 27.6 | 12.85 | 14.75 | 28.2 | - |
| RS60-NEP-2 | | | | | | | | 50.5 | 24.25 | 26.25 | 52.6 | 22.8 |
| RS80-NEP-1 | 25.40 | 15.88 | 15.88 | 3.2 | 24.1 | 20.8 | 7.94 | 35.5 | 16.25 | 19.25 | 38.2 | - |
| RS80-NEP-2 | | | | | | | | 64.8 | 30.9 | 33.9 | 67.5 | 29.3 |
| RS100-NEP-1 | 31.75 | 19.05 | 19.05 | 4.0 | 30.1 | 26.0 | 9.54 | 42.6 | 19.75 | 22.85 | 45.7 | - |
| RS100-NEP-2 | | | | | | | | 78.5 | 37.7 | 40.8 | 81.5 | 35.8 |
| RS120-NEP-1 | 38.10 | 22.23 | 25.40 | 4.8 | 36.2 | 31.2 | 11.11 | 53.8 | 24.9 | 28.9 | 57.8 | - |
| RS140-NEP-1 | 44.45 | 25.40 | 25.40 | 5.6 | 42.2 | 36.4 | 12.71 | 58.6 | 26.9 | 31.7 | 63.4 | - |
| RS160-NEP-1 | 50.80 | 28.58 | 31.75 | 6.4 | 48.2 | 41.6 | 14.29 | 68.7 | 31.85 | 36.85 | 73.6 | - |

| TSUBAKI Chain Number | Minimum Tensile Strength kN{kgf} | Maximum Allowable Load kN{kgf} | Approximate Mass kg/m | Links per Unit |
|----------------------|-------------------------------------|-----------------------------------|--------------------------|----------------|
| RS35-NEP-1 | 9.81 { 1000 } | 2.16 { 220 } | 0.33 | 320 |
| RS40-NEP-1 | 17.7 { 1800 } | 3.63 { 370 } | 0.64 | |
| RS40-NEP-2 | 35.3 { 3600 } | 6.18 { 630 } | 1.27 | 240 |
| RS50-NEP-1 | 28.4 { 2900 } | 6.37 { 650 } | 1.04 | |
| RS50-NEP-2 | 56.9 { 5800 } | 10.7 { 1100 } | 2.07 | 192 |
| RS60-NEP-1 | 40.2 { 4100 } | 8.83 { 900 } | 1.53 | |
| RS60-NEP-2 | 80.4 { 8200 } | 15.0 { 1530 } | 3.04 | 160 |
| RS80-NEP-1 | 71.6 { 7300 } | 14.7 { 1500 } | 2.66 | |
| RS80-NEP-2 | 143 { 14600 } | 25.0 { 2550 } | 5.27 | 120 |
| RS100-NEP-1 | 107 { 10900 } | 22.6 { 2300 } | 3.99 | |
| RS100-NEP-2 | 214 { 21800 } | 38.3 { 3910 } | 7.85 | 96 |
| RS120-NEP-1 | 148 { 15100 } | 30.4 { 3100 } | 5.93 | |
| RS140-NEP-1 | 193 { 19700 } | 40.2 { 4100 } | 7.49 | 68 |
| RS160-NEP-1 | 255 { 26000 } | 53.0 { 5400 } | 10.10 | |

1. Maximum allowable load is 65% of the above values when using a one-pitch offset link.
2. RS35-NEP is a bushed chain.
3. Multi-strand RS35-NEP is not available.
4. Models in bold are stock items. All other models are made-to-order.
5. 2-pitch offset links are not available.

Operating Temperature Range:

-10°C - 150°C (Use a high temperature lubricant when using above 60°C. Contact a Tsubaki representative when using in temperatures beyond the ranges given.)

Selection/Handling

Refer to the Tsubaki Drive Chains & Sprockets catalog for information on selection and handling.

Precautions in Use

- Galvanic corrosion may occur when steel chains are used with stainless steel sprockets, promoting premature wear. Avoid mutual contact as much as possible. In-house tests have shown that the middle links of multi-strand chains have slightly less corrosion resistance than with single-strand chains.
- Uses a different surface treatment than other parts in order to reduce the size of film flakes during roller engagement or sliding.
- Do not use if there is a risk that the chain will come into direct contact with food, or if film flakes or wear debris will mix in with food. Install a cover when using in non-food environments where film flakes and wear dust will be problems, or contact a Tsubaki representative regarding chain selection.

Neptune RS Attachment Chain

Chain Numbering Example

RS50-NEP-1L A1

Chain size

Neptune code

Att. type

Att. spacing

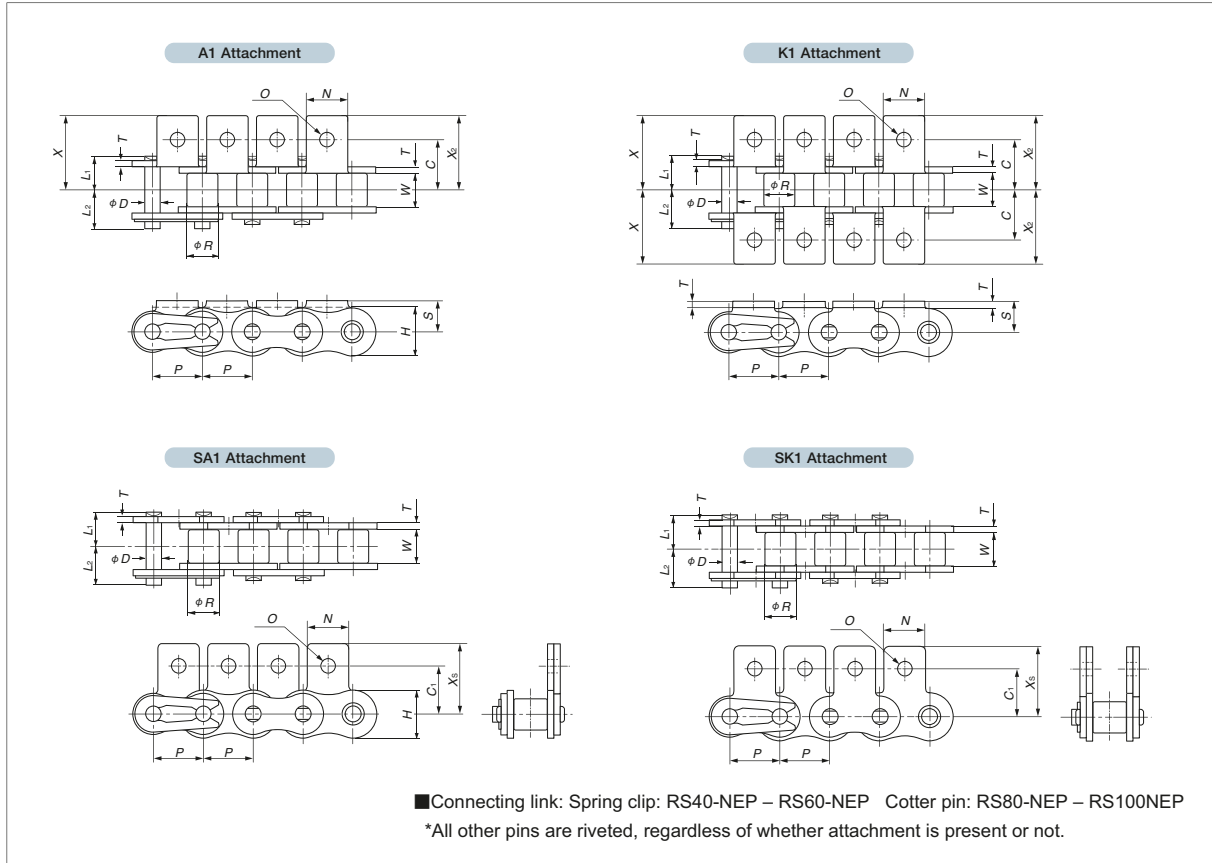

| TSUBAKI Chain Number | Pitch <i>P</i> | Roller Diameter <i>R</i> | Inner Width of Inner Link <i>W</i> | Plate | | Pin | | | Minimum Tensile Strength kN[kgf] | Maximum Allowable Load kN[kgf] | Approximate Mass kg/m |
|----------------------|-------------------|-----------------------------|---------------------------------------|-----------------------|--------------------|----------------------|-----------------------|-----------------------|-------------------------------------|-----------------------------------|--------------------------|
| | | | | Thickness <i>T</i> | Height <i>H</i> | Diameter <i>D</i> | <i>L</i> ₁ | <i>L</i> ₂ | | | |
| RS40-NEP | 12.70 | 7.92 | 7.95 | 1.5 | 12.0 | 3.97 | 8.25 | 9.95 | 14.7 {1500} | 2.65 { 270} | 0.64 |
| RS50-NEP | 15.875 | 10.16 | 9.53 | 2.0 | 15.0 | 5.09 | 10.3 | 12.0 | 23.5 {2400} | 4.31 { 440} | 1.04 |
| RS60-NEP | 19.05 | 11.91 | 12.70 | 2.4 | 18.1 | 5.96 | 12.85 | 14.75 | 35.3 {3600} | 6.28 { 640} | 1.53 |
| RS80-NEP | 25.40 | 15.88 | 15.88 | 3.2 | 24.1 | 7.94 | 16.25 | 19.25 | 60.8 {6200} | 10.7 {1090} | 2.66 |
| RS100-NEP | 31.75 | 19.05 | 19.05 | 4.0 | 30.1 | 9.54 | 19.75 | 22.85 | 93.2 {9500} | 17.1 {1740} | 3.99 |

| TSUBAKI Chain Number | Attachments | | | | | | | | | Mass per Attachment kg | | Links per Unit |
|----------------------|-------------|-----------------------|----------|----------|----------|----------|-----------------------|-----------------------|------------------|---------------------------|-----|----------------|
| | <i>C</i> | <i>C</i> ₁ | <i>N</i> | <i>O</i> | <i>S</i> | <i>X</i> | <i>X</i> ₂ | <i>X</i> ₂ | A/SA Attachments | K/SK Attachments | | |
| RS40-NEP | 12.7 | 12.7 | 9.5 | 3.6 | 8.0 | 17.8 | 17.8 | 17.40 | 0.002 | 0.004 | 240 | |
| RS50-NEP | 15.9 | 15.9 | 12.7 | 5.2 | 10.3 | 23.4 | 23.4 | 23.05 | 0.003 | 0.006 | 192 | |
| RS60-NEP | 19.05 | 18.3 | 15.9 | 5.2 | 11.9 | 28.2 | 28.2 | 26.85 | 0.007 | 0.014 | 160 | |
| RS80-NEP | 25.4 | 24.6 | 19.1 | 6.8 | 15.9 | 36.6 | 36.6 | 35.45 | 0.013 | 0.026 | 120 | |
| RS100-NEP | 31.75 | 31.8 | 25.4 | 8.7 | 19.8 | 44.9 | 44.9 | 44.00 | 0.026 | 0.052 | 96 | |

1. All models made-to-order.
2. *O* is marginally smaller.

Operating Temperature Range:

-10°C - 150°C (Use a high temperature lubricant when using above 60°C. Contact a Tsubaki representative when using in temperatures beyond the ranges given.)

Selection/Handling

Refer to the Tsubaki Small Size Conveyor Chain catalog for information on selection and handling.

Precautions in Use

- Galvanic corrosion may occur when steel chains are used with stainless steel sprockets, promoting premature wear. Avoid mutual contact as much as possible. In-house tests have shown that the middle links of multi-strand chains have slightly less corrosion resistance than with single-strand chains.
- Uses a different surface treatment than other parts in order to reduce the size of film flakes during roller engagement or sliding.
- Do not use if there is a risk that the chain will come into direct contact with food, or if film flakes or wear debris will mix in with food. Install a cover when using in non-food environments where film flakes and wear dust will be problems, or contact a Tsubaki representative regarding chain selection.

Specifications and Drawings

Neptune Double Pitch Chain

Chain Numbering Example

RF2050R-NEP-1L A2

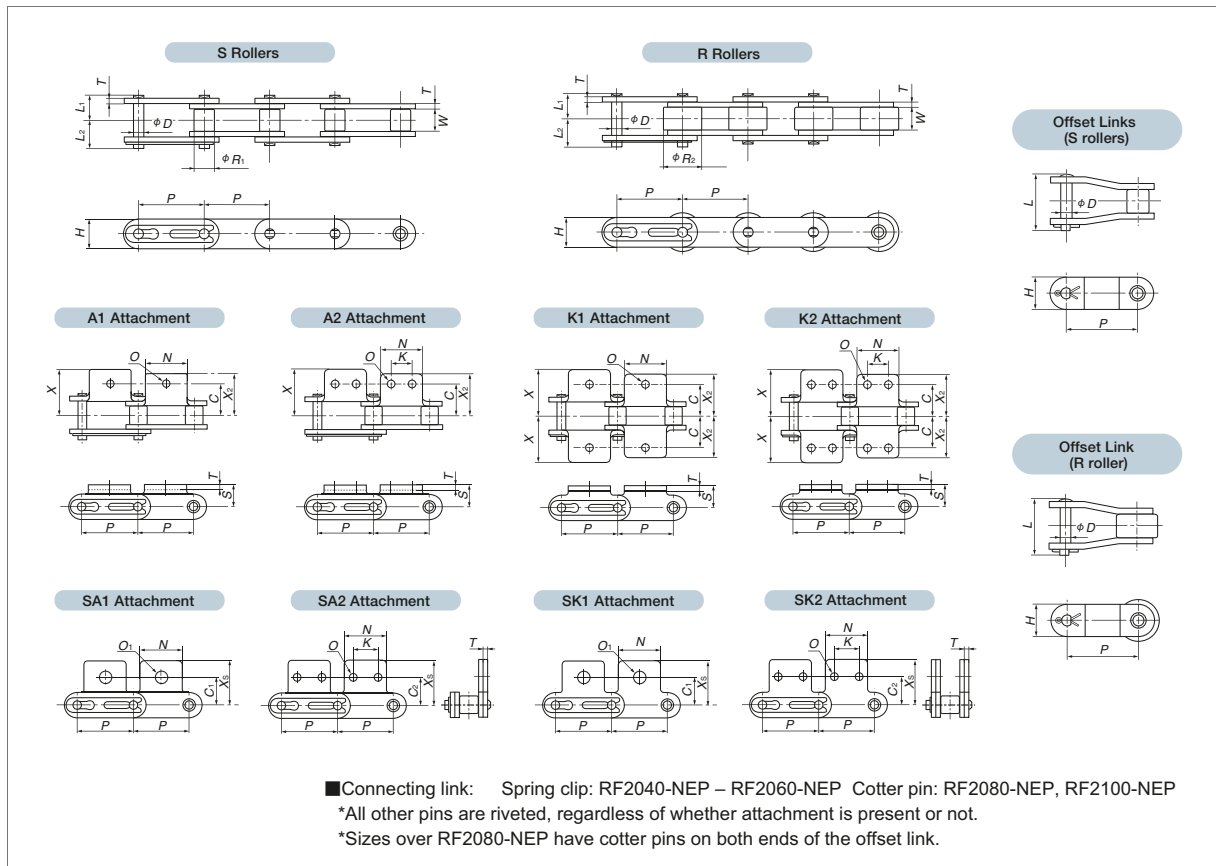
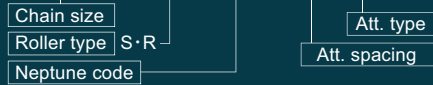

| TSUBAKI Chain Number | Roller Type | Pitch P | Roller Dia. | | Inner Width of Inner Link W | Plate | | Pin | | | | Approximate Mass kg/m | | Minimum Tensile Strength kN[kgf] | Maximum Allowable Load kN[kgf] |
|----------------------|-------------|---------|-------------------------|-------------------------|-----------------------------|-------------|----------|--------|----------------|----------------|---------------------|-----------------------|----------|----------------------------------|--------------------------------|
| | | | S Roller R ₁ | R Roller R ₂ | | Thickness T | Height H | Dia. D | L ₁ | L ₂ | Offset Pin Length L | S Roller | R Roller | | |
| RF2040-NEP | S, R | 25.40 | 7.92 | 15.88 | 7.95 | 1.5 | 12.0 | 3.97 | 8.25 | 9.95 | 18.2 | 0.51 | 0.87 | 14.7 {1500} | 2.65 { 270} |
| RF2050-NEP | | 31.75 | 10.16 | 19.05 | 9.53 | 2.0 | 15.0 | 5.09 | 10.30 | 12.0 | 22.6 | 0.84 | 1.30 | 23.5 {2400} | 4.31 { 440} |
| RF2060-NEP | | 38.10 | 11.91 | 22.23 | 12.70 | 3.2 | 17.2 | 5.96 | 14.55 | 16.55 | 31.5 | 1.51 | 2.19 | 35.3 {3600} | 6.28 { 640} |
| RF2080-NEP | | 50.80 | 15.88 | 28.58 | 15.88 | 4.0 | 23.0 | 7.94 | 18.30 | 20.90 | 41.9 | 2.41 | 3.52 | 60.8 {6200} | 10.7 {1090} |
| RF2100-NEP | | 63.50 | 19.05 | 39.69 | 19.05 | 4.8 | 28.6 | 9.54 | 21.80 | 24.50 | 49.0 | 3.54 | 5.80 | 93.2 {9500} | 17.1 {1740} |

| TSUBAKI Chain Number | Attachments | | | | | | | | | | | | Mass per Attachment kg | | Links per Unit |
|----------------------|-------------|----------------|----------------|------|------|-----|----------------|------|-----|------|----------------|----------------|------------------------|-----------------|----------------|
| | C | C ₁ | C ₂ | K | N | O | O ₁ | S | T | X | X ₂ | X _S | A/SA Attachment | K/SK Attachment | |
| RF2040-NEP | 12.7 | 11.1 | 13.6 | 9.5 | 19.1 | 3.6 | 5.2 | 9.1 | 1.5 | 19.3 | 17.6 | 19.8 | 0.003 | 0.006 | 120 |
| RF2050-NEP | 15.9 | 14.3 | 15.9 | 11.9 | 23.8 | 5.2 | 6.8 | 11.1 | 2.0 | 24.2 | 22.0 | 24.6 | 0.006 | 0.012 | 96 |
| RF2060-NEP | 21.45 | 17.5 | 19.1 | 14.3 | 28.6 | 5.2 | 8.7 | 14.7 | 3.2 | 31.5 | 28.2 | 30.6 | 0.017 | 0.034 | 80 |
| RF2080-NEP | 27.8 | 22.2 | 25.4 | 19.1 | 38.1 | 6.8 | 10.3 | 19.1 | 4.0 | 40.7 | 36.6 | 40.5 | 0.032 | 0.064 | 60 |
| RF2100-NEP | 33.35 | 28.6 | 31.8 | 23.8 | 47.6 | 8.7 | 14.3 | 23.4 | 4.8 | 49.9 | 44.9 | 50.4 | 0.060 | 0.120 | 48 |

- All models made-to-order.
- O, O₁ dimensions are marginally smaller.

Operating Temperature Range:

-10°C - 150°C (Use a high temperature lubricant when using above 60°C. Contact a Tsubaki representative when using in temperatures beyond the ranges given.)

Selection/Handling

Refer to the Tsubaki Small Size Conveyor Chain catalog for information on selection and handling.

Precautions in Use

- Galvanic corrosion may occur when steel chains are used with stainless steel sprockets, promoting premature wear. Avoid mutual contact as much as possible. In-house tests have shown that the middle links of multi-strand chains have slightly less corrosion resistance than with single-strand chains.
- Uses a different surface treatment than other parts in order to reduce the size of film flakes during roller engagement or sliding.
- Do not use if there is a risk that the chain will come into direct contact with food, or if film flakes or wear debris will mix in with food. Install a cover when using in non-food environments where film flakes and wear dust will be problems, or contact a Tsubaki representative regarding chain selection.

Neptune BS/DIN Drive Chain

Chain Numbering Example

RS08B-NEP-1

Chain size

Neptune code

No. of strands

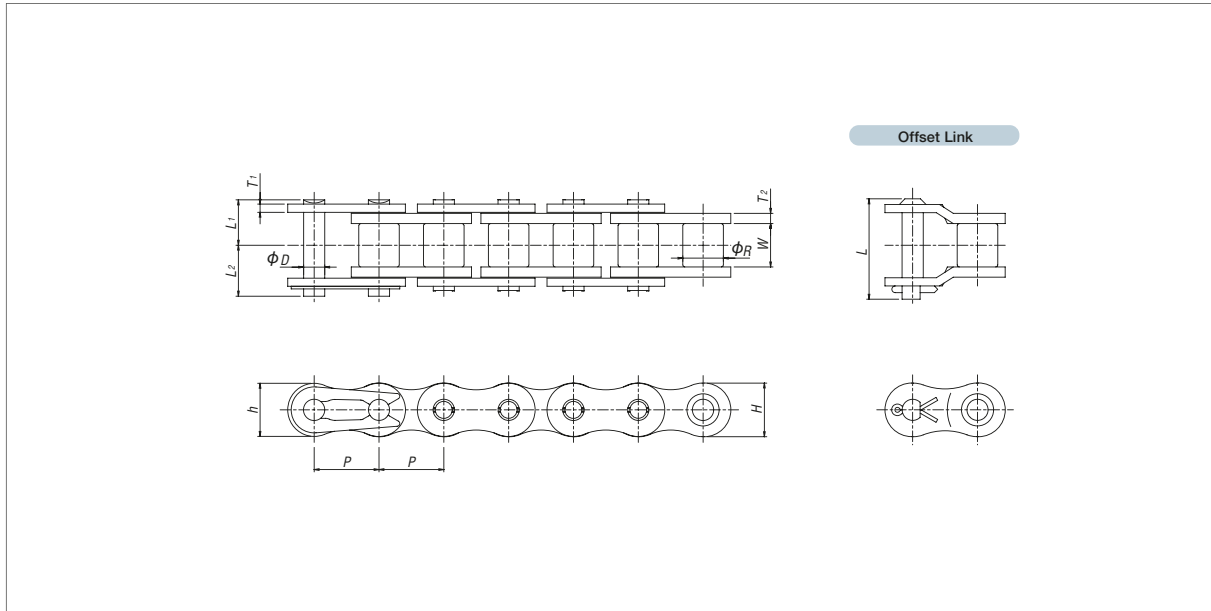

| TSUBAKI Chain Number | Pitch P | Roller Dia. (Bushing Dia.) R | Inner Width of Inner Link W | Plate | | | | Pin | | | | | Transverse Pitch C |
|----------------------|---------|------------------------------|-----------------------------|--------------------------|--------------------------|----------|----------|------------|--------------------------------|----------------|----------------|---------------------|--------------------|
| | | | | Thickness T ₁ | Thickness T ₂ | Height H | Height h | Diameter D | L ₁ +L ₂ | L ₁ | L ₂ | Offset Pin Length L | |
| RFO6B-NEP-1 | 9.525 | 6.35 | 5.72 | 1.0 | 1.3 | 8.2 | 8.2 | 3.27 | 13.8 | 6.1 | 7.7 | 15.1 | - |
| RS08B-NEP-1 | 12.70 | 8.51 | 7.75 | 1.6 | 1.6 | 11.8 | 10.4 | 4.45 | 18.4 | 8.4 | 10.0 | 18.6 | - |
| RS08B-NEP-2 | | | | | | | | | 32.2 | 15.3 | 16.9 | 34.5 | 13.92 |
| RS10B-NEP-1 | 15.875 | 10.16 | 9.65 | 1.5 | 1.5 | 14.7 | 13.7 | 5.08 | 20.8 | 9.55 | 11.25 | 20.8 | - |
| RS10B-NEP-2 | | | | | | | | | 37.4 | 17.85 | 19.55 | 39.4 | 16.59 |
| RS12B-NEP-1 | 19.05 | 12.07 | 11.68 | 1.8 | 1.8 | 16.1 | 16.1 | 5.72 | 24.1 | 11.1 | 13.0 | 24.4 | - |
| RS12B-NEP-2 | | | | | | | | | 43.6 | 20.85 | 22.75 | 45.9 | 19.46 |
| RS16B-NEP-1 | 25.40 | 15.88 | 17.02 | 3.2 | 4.0 | 21.0 | 21.0 | 8.28 | 37.7 | 17.75 | 19.95 | 41.1 | - |
| RS16B-NEP-2 | | | | | | | | | 69.3 | 33.55 | 35.75 | 75.2 | 31.88 |
| RS20B-NEP-1 | 31.75 | 19.05 | 19.56 | 3.4 | 4.4 | 26.0 | 26.0 | 10.19 | 43.0 | 19.9 | 23.1 | 46.6 | - |
| RS20B-NEP-2 | | | | | | | | | 79.7 | 38.25 | 41.45 | 84.6 | 36.45 |
| RS24B-NEP-1 | 38.10 | 25.40 | 25.4 | 5.6 | 6.0 | 33.4 | 31.2 | 14.63 | 58.5 | 26.65 | 31.85 | 61.7 | - |
| RS28B-NEP-1 | 44.45 | 27.94 | 30.99 | 6.3 | 7.5 | 36.4 | 36.4 | 15.90 | 69.9 | 32.45 | 37.45 | 74.4 | - |
| RS32B-NEP-1 | 50.80 | 29.21 | 30.99 | 6.3 | 7.0 | 42.2 | 41.6 | 17.81 | 69.8 | 32.1 | 37.7 | 73.3 | - |

| TSUBAKI Chain Number | Minimum Tensile Strength kN{kgf} | Maximum Allowable Load kN{kgf} | Approximate Mass kg/m | Links per Unit |
|----------------------|----------------------------------|--------------------------------|-----------------------|----------------|
| RFO6B-NEP-1 | 9.0 { 920 } | 1.95 { 199 } | 0.39 | 320 |
| RS08B-NEP-1 | 19.0 { 1930 } | 3.80 { 387 } | 0.70 | 240 |
| RS08B-NEP-2 | 32.0 { 3260 } | 6.46 { 659 } | 1.35 | |
| RS10B-NEP-1 | 23.0 { 2340 } | 4.52 { 461 } | 0.95 | 192 |
| RS10B-NEP-2 | 44.5 { 4540 } | 7.68 { 783 } | 1.85 | |
| RS12B-NEP-1 | 31.0 { 3160 } | 5.28 { 538 } | 1.25 | 160 |
| RS12B-NEP-2 | 61.0 { 6220 } | 8.98 { 916 } | 2.50 | |
| RS16B-NEP-1 | 70.0 { 7100 } | 13.1 {1340 } | 2.70 | 120 |
| RS16B-NEP-2 | 128 {13000 } | 22.3 {2270 } | 5.40 | |
| RS20B-NEP-1 | 98.1 {10000 } | 18.4 {1880 } | 3.85 | 96 |
| RS20B-NEP-2 | 197 {20100 } | 31.3 {3190 } | 7.65 | |
| RS24B-NEP-1 | 167 {17000 } | 27.1 {2760 } | 7.45 | 80 |
| RS28B-NEP-1 | 200 {20400 } | 37.5 {3820 } | 9.45 | 68 |
| RS32B-NEP-1 | 255 {26000 } | 41.0 {4180 } | 10.25 | 60 |

1. Maximum allowable load is 65% of the above values when using a one-pitch offset link.
2. 2POL is not available.

Operating Temperature Range:

-10°C - 150°C (Use a high temperature lubricant when using above 60°C. Contact a Tsubaki representative when using in temperatures beyond the ranges given.)

Selection/Handling

Refer to the Tsubaki Drive Chains & Sprockets catalog for information on selection and handling.

Precautions in Use

- Galvanic corrosion may occur when steel chains are used with stainless steel sprockets, promoting premature wear. Avoid mutual contact as much as possible. In-house tests have shown that the middle links of multi-strand chains have slightly less corrosion resistance than with single-strand chains.
- Uses a different surface treatment than other parts in order to reduce the size of film flakes during roller engagement or sliding.
- Do not use if there is a risk that the chain will come into direct contact with food, or if film flakes or wear debris will mix in with food. Install a cover when using in non-food environments where film flakes and wear dust will be problems, or contact a Tsubaki representative regarding chain selection.

Specifications and Drawings

Neptune BS/DIN Attachment Chain

■ Chain Numbering Example

RS08B-NEP-1LA1

Chain size

Neptune code

Attachment type

Attachment spacing

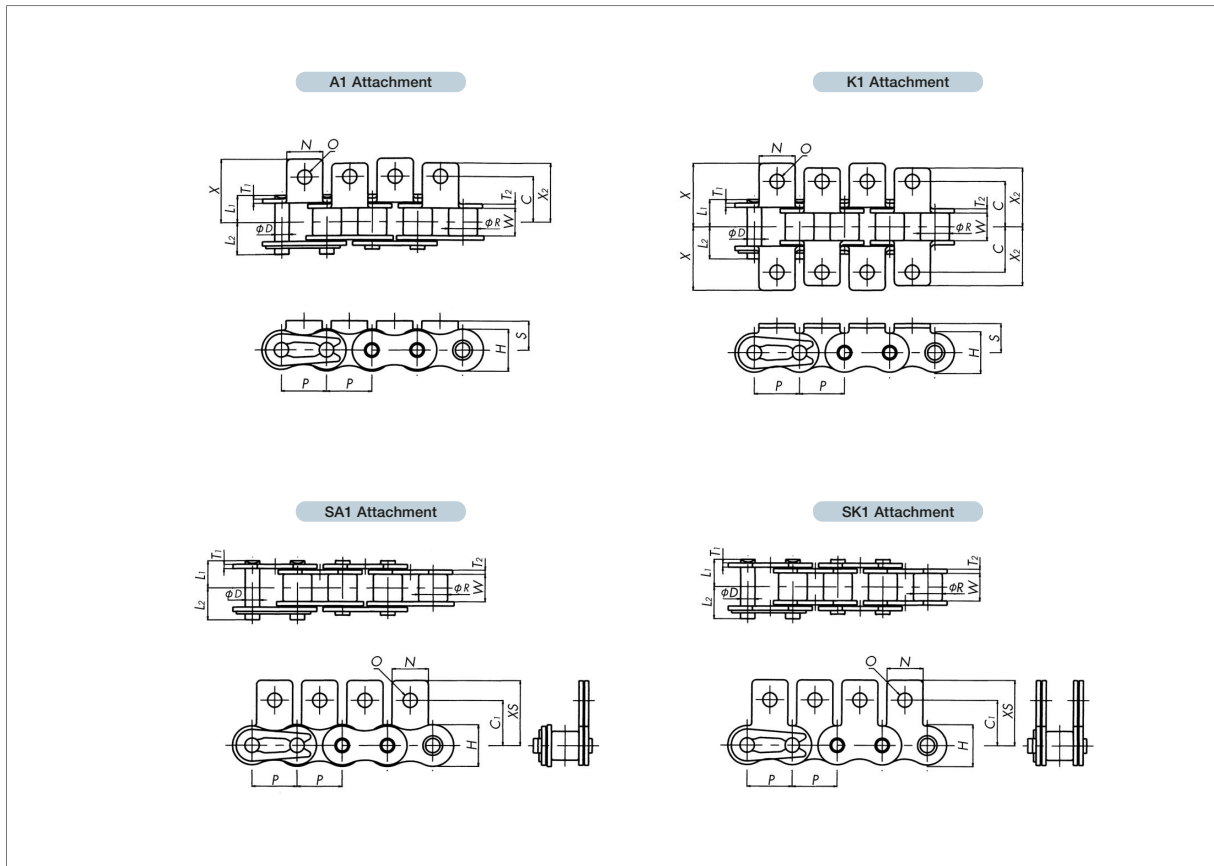

| TSUBAKI Chain Number | Pitch <i>P</i> | Roller Diameter <i>R</i> | Inner Width of Inner Link <i>W</i> | Plate | | | | Pin | | | Minimum Tensile Strength kN[kgf] | Approximate Mass kg/m |
|----------------------|-------------------|-----------------------------|---------------------------------------|-----------------------------------|-----------------------------------|--------------------|--------------------|----------------------|----------------------|----------------------|-------------------------------------|--------------------------|
| | | | | Thickness <i>T₁</i> | Thickness <i>T₂</i> | Height <i>H</i> | Height <i>h</i> | Diameter <i>D</i> | <i>L₁</i> | <i>L₂</i> | | |
| RS08B-NEP | 12.70 | 8.51 | 7.75 | 1.6 | 1.6 | 11.8 | 10.4 | 4.45 | 8.4 | 10.0 | 12.9 {1320} | 0.70 |
| RS10B-NEP | 15.875 | 10.16 | 9.65 | 1.5 | 1.5 | 14.7 | 13.7 | 5.08 | 9.55 | 11.25 | 15.7 {1600} | 0.95 |
| RS12B-NEP | 19.05 | 12.07 | 11.68 | 1.8 | 1.8 | 16.1 | 16.1 | 5.72 | 11.1 | 13.0 | 22.1 {2250} | 1.25 |
| RS16B-NEP | 25.40 | 15.88 | 17.02 | 4.0 | 3.2 | 21.0 | 21.0 | 8.28 | 17.75 | 19.95 | 56.2 {5730} | 2.70 |

| TSUBAKI Chain Number | Attachments | | | | | | | | Mass per Attachment kg | | Links per Unit |
|----------------------|-------------|----------------------|----------|----------|----------|----------|----------------------|-----------|---------------------------|------------------|----------------|
| | <i>C</i> | <i>C₁</i> | <i>N</i> | <i>O</i> | <i>S</i> | <i>X</i> | <i>X₂</i> | <i>XS</i> | A/SA Attachments | K/KA Attachments | |
| RS08B-NEP | 11.9 | 12.7 | 11.4 | 4.2 | 8.9 | 19.05 | 17.15 | 19.3 | 0.002 | 0.004 | 240 |
| RS10B-NEP | 15.9 | 15.9 | 12.7 | 5.0 | 10.2 | 22.25 | 20.6 | 22.9 | 0.003 | 0.006 | 192 |
| RS12B-NEP | 19.05 | 22.2 | 16.5 | 7.1 | 13.5 | 29.85 | 27.8 | 32.05 | 0.006 | 0.012 | 160 |
| RS16B-NEP | 23.8 | 23.9 | 24.3 | 6.7 | 15.2 | 37.35 | 34.4 | 34.1 | 0.014 | 0.028 | 120 |

1. All models made-to-order.
2. *O* is marginally smaller.

■ Operating Temperature Range:

-10°C - 150°C (Use a high temperature lubricant when using above 60°C. Contact a Tsubaki representative when using in temperatures beyond the ranges given.)

■ Selection/Handling

Refer to the Tsubaki Small Size Conveyor Chain catalog for information on selection and handling.

■ Precautions in Use

- Galvanic corrosion may occur when steel chains are used with stainless steel sprockets, promoting premature wear. Avoid mutual contact as much as possible. In-house tests have shown that the middle links of multi-strand chains have slightly less corrosion resistance than with single-strand chains.
- Uses a different surface treatment than other parts in order to reduce the size of film flakes during roller engagement or sliding.
- Do not use if there is a risk that the chain will come into direct contact with food, or if film flakes or wear debris will mix in with food. Install a cover when using in non-food environments where film flakes and wear dust will be problems, or contact a Tsubaki representative regarding chain selection.

For Your Safety When Using the Chain



Warning To avoid danger, observe the following rules.

- Do not use chain or chain accessories for any purpose other than their originally intended use.
- Never perform additional work on chain.
 - Do not anneal any chain parts.
 - Do not clean chain with acids or alkalis. These may cause cracking.
 - Never attempt to electroplate chain or chain parts. This may cause hydrogen embrittlement.
 - Do not weld chain. Heating effects will cause weakening and cracking.
 - When a torch is used to heat or cut chain, remove the links on each side and do not reuse them.
- When replacing a worn or damaged part, do not replace just the worn or damaged part. Replace all parts with new parts.
- If a material that causes hydrogen embrittlement (acid, strong alkali, battery fluid, etc.) comes in contact with the chain, immediately stop using the chain and replace it with new chain.
- When using chain in a lifting device, set up a safety barrier and do not allow anyone to go under the equipment.
- Always install safety equipment (safety covers, etc.) on chain and sprockets.
- Strictly observe the general guidelines listed in Section 1, Chapter 1, 2nd Edition of the Japanese Occupational Safety and Health Regulations as well as rules and regulations concerning occupational safety and health in your region/country.
- When installing, removing, inspecting, maintaining and oiling chain,
 - Perform the work as instructed in the manual, catalog or other documentation that was provided with the product.
 - Before starting work, turn off the power switch and take measures to prevent it from being turned on accidentally.
 - Secure the chain and parts to prevent them from moving freely.
 - Use a press tool or other special tools to separate or connect chain, and follow the correct procedures.
 - Remove and insert pins and rivets in the correct direction.
 - Wear clothing and protective gear (safety glasses, gloves, safety shoes, etc.) that are appropriate for the work.
 - Only experienced personnel should perform chain replacement.



Caution To prevent accidents, observe the following rules.

- Understand the structure and specifications of the chain that you are handling.
- Before installing chain, inspect it to make sure no damage occurred during delivery.
- Inspect and maintain chain and sprockets at regular intervals.
- Chain strength varies by manufacturer. Only Tsubaki products should be used when chain is selected using Tsubaki catalogs.
- Minimum tensile strength refers to the failure point when the corresponding load is applied to the chain once and does not refer to the allowable operational load.

Warranty

1. LIMITED WARRANTY

Products manufactured by Seller: (a) conform to the design and specifications, if any, expressly agreed to in writing by Seller; and (b) are free of defects in workmanship and materials at the time of shipment. The warranties set forth in the preceding sentence are exclusive of all other warranties, express or implied, and extend only to Buyer and to no other person. ALL WARRANTIES OF MERCHANTABILITY OR FITNESS FOR A PARTICULAR PURPOSE ARE HEREBY EXCLUDED.

2. NON-RELIANCE

Buyer is not relying upon any advice, representations or warranties (except the warranties expressly set forth above) of Seller, or upon Seller's skill or judgment regarding the Seller's products.

Buyer is solely responsible for the design and specifications of the products, including without limitation, the determination of suitability for Buyer's application of the products.

3. CLAIMS

- (a) Any claim relating to quantity or type shall be made to Seller in writing within 7 days after receipt of the products; any such claim made thereafter shall be barred.
- (b) Any claim under the above-stated Limited Warranty shall be made to Seller in writing within three (3) months after receipt of the products; any such claim made thereafter shall be barred.
- (c) Seller's liability for breach of warranty or otherwise is limited to repair or replacement, at Seller's option, of non-conforming or defective products. Buyer waives all other remedies, including, but not limited to, all rights to consequential, special or incidental damages, including,

but not limited to, damages resulting from personal injury, death or damage to or loss of use of property.

- (d) Repair, alteration, neglect or misuse of the products shall void all applicable warranties.

4. INDEMNIFICATION

Buyer will indemnify, defend and hold Seller harmless from all loss, liability, damage and expense, including attorneys' fees, arising out of any claim (a) for infringement of any patent, trademark, copyright, misappropriation of trade secrets, unfair competition or similar charge by any products supplied by Seller in accordance with the design or specifications furnished by Buyer, or (b) arising out of or connected with the products or any items into which the products are incorporated, including, but not limited to, any claim for product liability (whether or not based on negligence or strict liability of Seller), breach of warranty, breach of contract or otherwise.

5. ENTIRE AGREEMENT

These terms and conditions constitute the entire agreement between Buyer and Seller and supersede any inconsistent terms and conditions, whether contained in Buyer's purchase order or otherwise, and whether made heretofore or hereafter.

No statement or writing subsequent to the date hereof which purports to modify or add to the terms and conditions hereof shall be binding unless consented to in writing, which makes specific reference hereto, and which has been signed by the party against which enforcement thereof is sought. Seller reserves the right to change these terms and conditions without prior notice.



TSUBAKIMOTO CHAIN CO.

| | | | |
|-------|--------------|-----------------|---|
| Japan | Headquarters | +81 6-6441-0011 | http://tsubakimoto.com |
|-------|--------------|-----------------|---|

Global Group Companies

AMERICAS

| | | | |
|--------------------------|---|------------------|---|
| United States of America | U.S. TSUBAKI POWER TRANSMISSION, LLC | +1 847-459-9500 | http://www.ustsubaki.com/ |
| Brazil | TSUBAKI BRASIL EQUIPAMENTOS INDUSTRIAIS LTDA. | +55 11-3253-5656 | http://tsubaki.ind.br/ |
| Canada | TSUBAKI of CANADA LIMITED | +1 905-676-0400 | http://tsubaki.ca/ |

EUROPE

| | | | |
|----------------|------------------------------|------------------|---|
| Netherlands | TSUBAKI EUROPE B.V. | +31 78-6204000 | http://tsubaki.eu/ |
| France | KABELSCHLEPP FRANCE S.A.R.L. | +33 1-34846365 | http://kabelschlepp.fr/ |
| Germany | TSUBAKI DEUTSCHLAND GmbH | +49 8105-7307100 | http://tsubaki.de/ |
| | TSUBAKI KABELSCHLEPP GmbH | +49 2762-4003-0 | http://kabelschlepp.de/ |
| Italy | KABELSCHLEPP ITALIA S.R.L. | +39 0331-350962 | http://kabelschlepp.it/ |
| Russia | OOO TSUBAKI KABELSCHLEPP | +7 499-4180212 | http://kabelschlepp.ru/ |
| United Kingdom | TSUBAKIMOTO U.K. LTD. | +44 1623-688-700 | http://tsubaki.eu/ |

INDIAN OCEAN RIM

| | | | |
|-------------|---|-------------------|---|
| Singapore | TSUBAKIMOTO SINGAPORE PTE. LTD. | +65 6861-0422/3/4 | http://tsubaki.sg/ |
| Australia | TSUBAKI AUSTRALIA PTY. LTD. | +61 2-9704-2500 | http://tsubaki.com.au/ |
| India | TSUBAKI INDIA POWER TRANSMISSION PTE. LTD. | +91 44-4231-5251 | http://tsubaki.sg/ |
| Indonesia | PT. TSUBAKI INDONESIA TRADING | +62 21-571-4230/1 | http://tsubakimoto.co.id/ |
| Malaysia | TSUBAKI POWER TRANSMISSION (MALAYSIA) SDN. BHD. | +60 3-7859-8585 | http://tsubaki.sg/ |
| New Zealand | TSUBAKI AUSTRALIA PTY LIMITED - NEW ZEALAND BRANCH | +64 275-082-726 | http://tsubaki.com.au/ |
| Philippines | TSUBAKIMOTO SINGAPORE PTE. LTD. - PHILIPPINES REPRESENTATIVE OFFICE | +63 2-464-7129 | http://tsubaki.ph/ |
| Thailand | TSUBAKIMOTO (THAILAND) CO., LTD. | +66 2-262-0667 | http://tsubaki.co.th/ |
| Vietnam | TSUBAKIMOTO VIETNAM CO., LTD. | +84 4-6274-1449 | http://tsubaki.net.vn/ |

EAST ASIA

| | | | |
|--------|-----------------------------|--------------------|---|
| Korea | TSUBAKIMOTO KOREA CO., LTD. | +82 2-2183-0311 | http://tsubakimoto-tck.co.kr/ |
| Taiwan | TAIWAN TSUBAKIMOTO CO. | +886 33-293827/8/9 | http://tsubakimoto.com.tw/ |

CHINA

| | | | |
|-------|--|-------------------|---|
| China | TSUBAKIMOTO CHAIN (SHANGHAI) CO., LTD. | +86 215396-6651/2 | http://tsubaki.cn/ |
|-------|--|-------------------|---|



The Tsubaki Eco Link logo is used only on products that satisfy the standards for environmental friendliness set by the Tsubaki Group.