

KABELSCHLEPP

TSUBAKI KABELSCHLEPP



TRAXLINE® DRAG CHAIN CABLES CABLES FOR MOTION

Continuous bending hi-flex cables
Assembled cables
... for cable carriers

Your personal contact

tsubaki-kabelschlepp.com/salesnetwork

Copyright

KABELSCHLEPP® products are constantly enhanced. They are subject to technical changes and assortment changes. Current information on our products can be found at tsubaki-kabelschlepp.com.

Illustrations and text in this catalog are purely informative and, in part, only exemplary. They do not represent any quality guarantee and do not assure suitability for a particular application. This catalog is subject to technical and optical changes. Orders to be placed in the future are subject to the legally agreed quality of the relevant product, or otherwise the quality of each product as it was at the time of the signing of the contract.

All rights of this catalog are reserved, including text and illustrations, as well as brand names and corporate logos/trademarks used, in particular the rights of photocopying, distribution, translation or any other form of editing as well as the right of public reproduction.

No part of this catalog, including brand names and corporate logos/trademarks may be reproduced, processed, photocopied or distributed in any form or by any means, especially optical, photo-mechanical, paper-based or electronic, without prior written permission of TSUBAKI KABELSCHLEPP GmbH.

Except hereof is the legally authorized use of photo-copying for merely private purposes (paragraph 53 German copyright law).

Imprint

Editor:
TSUBAKI KABELSCHLEPP GmbH
Daimlerstraße 2, D-57482 Wenden-Gerlingen

Layout and Realisation:
Schmelzer Medien GmbH
Eiserntalstraße 161, D-57080 Siegen

Terms and conditions:
Our current terms and conditions of sales and delivery can be found at tsubaki-kabelschlepp.com/gtc

© 2019 · TSUBAKI KABELSCHLEPP GmbH

Content

01	Introduction	4	02	Cable range	10
	TSUBAKI KABELSCHLEPP.....	4		Cable series.....	10
	TRAXLINE®.....	6		Cable overview.....	12
	TOTALTRAX®.....	8			
03	Control cables	18	04	Power cables	36
	CONTROL 200.....	20		POWER 400 1 kV.....	38
	CONTROL 200 C.....	22		POWER 400 C 1 kV.....	40
	CONTROL 400 600 V.....	24		POWER 700 1 kV.....	42
	CONTROL 400 C 600 V.....	26		POWER 700 C 1 kV.....	44
	CONTROL 700 600 V.....	28		POWER 1000 TPE 1 kV.....	46
	CONTROL 700 C 600 V.....	30		POWER 1000 C TPE 1 kV.....	48
	CONTROL 1000 TPE 300/500 V.....	32		POWER ONE 700 1 kV.....	50
	CONTROL 1000 C TPE 300/500 V.....	34		POWER ONE 700 C 1 kV.....	52
				POWER ONE 700 PE.....	54
				POWER ONE 1000 TPE 1 kV.....	56
				POWER ONE 1000 C TPE 1 kV.....	58
05	High voltage cables	60	06	Data cables	68
	POWER ONE HEAVY DUTY 6/10 kV.....	62		DATA 400 C.....	70
	POWER ONE HEAVY DUTY 6.7/11 kV.....	64		DATA 700.....	72
	POWER ONE HEAVY DUTY 7.2/12 kV.....	66		DATA 700 Tpi C.....	74
				DATA 700 Tpi CD.....	76
				DATA 700 Tpi CD 1 kV.....	78
				DATA 1000 Tpi C TPE.....	80
07	BUS cables	82	08	Coaxial cables	102
	PROFIBUS 700 CD.....	84		KOAX 700 C 50 Ohm.....	104
	PROFIBUS 700 CD 90°C.....	86		KOAX 700 C 75 Ohm.....	106
	PROFINET 700 CD.....	88		KOAX 700 CD 50 Ohm.....	108
	CAN-BUS 700 C.....	90		KOAX 700 CD 75 Ohm.....	110
	USB 2.0 S 700 CD.....	92			
	USB 2.0 L 700 CD.....	94			
	USB 3.0 700 CD.....	96			
	CAT.5E 700 CD.....	98			
	CAT.6 700 CD.....	100			
09	Fiber optic cables	112	10	OEM cables	116
	FOC 700.....	114		System M 700 C.....	118
				System M 700 CD.....	120
				System S 700 C.....	122
				System S 700 CD.....	124
11	Assembled cables	126	12	Cable engineering	164
	Cables according to OEM.....	128		TRAXLINE® Scout.....	166
	Other OEM assembled cables.....	158		Construction elements.....	167
	Assembled USB / CAT cables.....	160		Norms and standards.....	170
	Assembled KOAX / FOC cables.....	162		Chemical resistance.....	172
				Electrical values.....	174
				Materials.....	176
13	Technical annex	178	14	Strain relief devices	208
	Selecting a suitable cable carrier.....	180		LineFix® clamps.....	210
	Placement guidelines for cables and hoses in cable carriers.....	188		Strain relief combs.....	214
	Installation variants.....	192		SZL strain reliefs.....	216
				Block clamps.....	217
				Assembly profiles.....	218



Over 60 years of innovations and thousands of realized applications

In 1953, the Waldrich Maschinenfabrik registered a global patent for a steel „unsupported cable carrier to protect moving cables and hoses“. The visionary company owner Dr. Oskar Waldrich recognized the invention’s potential and established his own subsidiary for the new product in 1954: KABELSCHLEPP. Since this launch, the company has been ensuring the continuous further development of the applications involving this machine and system component – constantly with new product concepts, innovative materials and extensive customer service.

TSUBAKI KABELSCHLEPP is currently a global player with international representatives and subsidiaries in more than 70 countries and cable carrier systems are a permanent component of almost every machine. Our innovative solutions have proven themselves worldwide in the most diverse industries – and in fact, no longer just in the classical application areas such as machine tools, crane systems, washing lines and medical and laboratory technology, but also in industrial robots, high-sea oil drilling platforms and space travel. Our experts

develop individual products even for complex and unusual fields of usage. In this process, the application defines the material – in addition to steel cable carriers, plastic and hybrid systems are also available. This allows for a wide range of products which can be used for countless applications. There is even an ideal solution for individual challenges – in standard widths or adapted to customer requirements on a millimeter grid. The range of products and accessories comprises over 100,000 variants. These include, for example, strain reliefs, divider systems, channels, hoses, cables, connectors and ready-to-install complete systems.



KABELSCHLEPP and TSUBAKI – together what fits together

TSUBAKI KABELSCHLEPP is integrated into the TSUBAKI Group since 2010 and made responsible for managing the worldwide Cable Carrier Systems business. For more than 40 years, both companies have been close cooperative partners. With this integration, we will leverage our successful working relationship in one strategic enterprise.

This global enterprise offers numerous advantages:

- An even larger product portfolio to select from
- Global yet locally supported – vast network of more than 40 international subsidiaries
- Global manufacturing operations allow for shorter delivery times
- Combined R&D resources allow for quick and innovative product development

KABELSCHLEPP + TSUBAKI = MORE

MORE Product Solutions

An expanded product portfolio of TSUBAKI products and KABELSCHLEPP cable carrier systems.

MORE Innovations

A combined global R&D with even more resources ensures a quicker response to our customer's needs.

MORE Regional Service

A combined TSUBAKI and KABELSCHLEPP sales force provides added local support. KABELSCHLEPP® products are also now available through the TSUBAKI network of distributors.

MORE Global Support

A unified global sales and support network extends to over 70 countries around the world, providing service and support when and where you need it most.

MORE Value

Together we will continue to prove our reputation as one of the industry's "Best Value" supplier in the industry.

TRAXLINE® cables for cable carriers

TSUBAKI KABELSCHLEPP – inventor of the cable carrier. The product portfolio comprises over 100,000 steel, plastic variants and hybrid systems. Always a suitable, reliable cable carrier, whether standard or individual complete solution. We are active for you worldwide. We use our more than 60 years of experience to continuously develop the „driving force“ – the TRAXLINE® cables – and adapt them to the requirements of the market.

Our cable series meet the highest quality standards to ensure the availability of your systems.

Product range

The TRAXLINE® range is continuously being optimized and expanded, especially for the ever increasing requirements of use in cable carriers. A clearly structured type selection provides a unique combination of performance characteristics and usage possibilities.

- Highest quality requirements
- Continuous bending hi-flex, very durable
- Complies with applicable standards and guidelines
- 2D applications (unsupported and gliding)
- For all environments from cleanroom applications to tough ambient conditions in a rough operating environment

Service & Support

- Competent, target-oriented system consultation and global on-site service
- Fast availability through stockkeeping of more than 500 cable types
- Special designs for projects

Our TRAXLINE® cables are continuous bending hi-flex and very durable. Tested functional reliability which meets applicable standards and guidelines is an essential criterion.

Competent, target-oriented system consultation and global on-site service are our constant commitment to the technical and economical optimization of your applications.

TSUBAKI KABELSCHLEPP cable warehouse

Over 500 cable types, constantly available from the warehouse, ensure fast availability around the globe. We deliver from stock.



TRAXLINE® Infocenter

With the aid of the TRAXLINE® info center, you can find the right cable for your cable carrier system with just a few mouse clicks. Simply enter the parameters for your application at traxline.de and find the ideal cable for your requirements.



Efficient design engineering Precise and fast

Decrease your engineering times, accelerate your design processes, configure with original data directly from the manufacturer.

We are continuously investing in providing product-related data online to make your work easier. This allows you to access current product and CAD data already during the design engineering phase.

We are currently offering comprehensive technical information materials in three online tools which are partially interlinked.



Our web-based OnlineEngineer platform with worldwide online access provides a variety of functions to support you with the selection and configuration of products for your application. All necessary technical and calculation information for the individual products from the areas of cable carriers, cables and other accessories are provided on a central, clearly structured platform. Selection of the suitable products is made substantially easier by entering different parameters.

For even more efficient use, the data portals of OnlineEngineer and CADENAS are linked. This allows you to quickly and easily download the suitable CAD model for your product configuration without having to exit OnlineEngineer.

CADENAS 3D CAD catalog

CADENAS is an internationally used platform for providing 3D component models in a variety of CAD formats. It includes a large number of renowned companies from mechanical engineering, plant engineering and other industry sectors. We are currently offering CAD models in all standard CAD formats for the entire product portfolio. The database also contains the corresponding models for guide channels and support trays. The catalog is continuously expanded and supplemented.

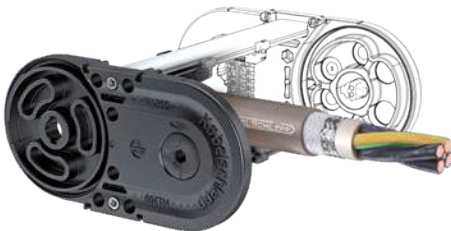

Electrical engineering with ePLAN

The ePLAN Data Portal is an integrated, web-based data platform for providing current device data of market-leading component manufacturers for direct use in project planning with the ePLAN software solution. For the internationally used project planning software ePLAN ELECTRIC P8, we have stored the corresponding data for our TRAXLINE® cables in the ePLAN Data Portal for download.



More information:
traxline.de



More information:
online-engineer.de



More information:
kabelschlepp.de/cadenas



More information:
kabelschlepp.de/eplan

System competence

TOTALTRAX® complete systems

As a specialist for cable carriers and drag chain cables of all kinds, we have been a reliable partner for many decades also when it comes to turnkey complete systems.

Thousands of systems implemented by us are in use worldwide, each individually adapted to the customer application. Whether single harnessed cable carrier or highly complex system – we offer ready-to-install assemblies for almost any area of application.

The following applies to all systems:

- Manufactured from high-quality components
- Perfectly adapted components
- Optimized turnaround times
- “Just-in-time” deliveries
- Complete systems from simple to complex

As a member of the TSUBAKI group, we are part of a globally operating group of companies. This allows us to offer our customers and partners the international presence of a global player combined with the flexibility and creativity of a medium-size enterprise.

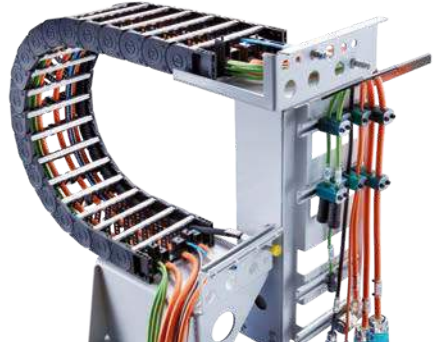

We take care of everything – and you can relax

Our system experts work with you to develop the technical solution as a reliable assembly for your product.

This also includes the correct selection of the individual parts and the procurement of purchase parts: smooth interaction

of all components is essential for a permanently functioning system.

The result: a customized part list based complete system consisting of up to several hundred individual components.

We support you with:

- Extensive consulting during planning
- Support for project planning
- Preparation of an individual cable plan
- Engineering for precision-fit interfaces
- Customized system as per customer requirements
- Procurement of all components
- Professional support during the entire project
- Only one contact – continuously from the first project planning meetings until installation
- Aftersales partnership

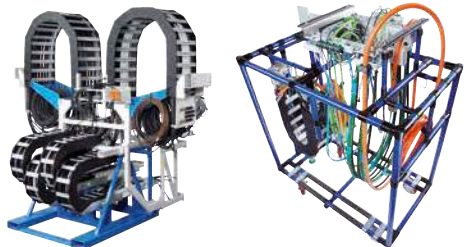
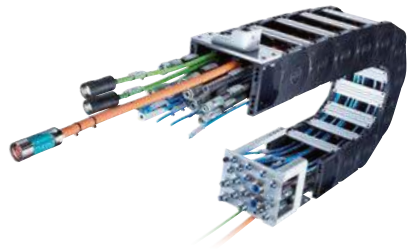

Our complete systems – delivered assembled and ready

Optimized manufacturing processes and coordinated provision of the correct components guarantee fast turnaround times and save you time and money, no matter how simple or complex your system is.

For large batches we can set up customer-specific production lines on request. We configure and manufacture economically viable individual solutions from a batch size of just one.

High-quality individual components make our complete systems reliable, resistant and durable. Regular checks

additionally ensure consistently high quality. We even confirm this in writing:

for individual components and

for ready-mounted assemblies – on request with certificate and comprehensive project documentation

We deliver the cable carrier “just in time” and ready for installation, to your production facility or to the desired installation site. Safely transported in single-use or returnable packaging, if required in an optimized transport frame.

Difficult installation situation?
Our service team can take on the installation or support you with their expertise.



The optimized process:



Standardized manufacturing processes



Use of high-quality components



Customized production line on request



Permanent quality control during production and assembly



Complete installation by our service team

Your benefits at a glance

Obtain your complete system from one source; that makes procurement easier while also saving time and money.

- Complete delivery from one responsibility
- One contact for the complete system
- No storage costs
- Reduced procurement costs by concentrating on one partner
- Reduced effort for goods incoming inspections
- Timely delivery directly to your production facility
- Shorter downtimes through plug & play installation

TRAXLINE®

Cables for Motion



Trademarks are legally protected for the TSUBAKI
KABELSCHLEPP GmbH as a national or international
registration in the following countries:
tsubaki-kabelschlepp.com/trademarks

Reliable – Robust – With high availability

TRAXLINE® cables for cable carriers: Reliable, robust with high availability. Your benefit from many years of experience combined with ongoing optimization, proven in tests

and applications. TRAXLINE® cables stand for competent system-supply with worldwide on-site service.

Our Series are available in different qualities:

- 200/200C: Layer stranded cables with PVC outer jacket for light to medium demands
- 400/400C: Bundle stranded cables with PVC outer jacket for medium heavy demands
- 700/700C: Bundle stranded cables with PUR outer jacket for heavy demands
- 1000/1000C: Bundle stranded cables with TPE outer jacket for really heavy loads

More information:
traxline.de

Control cables



Hi-flex Control cables for use in cable carriers

- Communication between transmitter and receiver
- Signal for turning on and off/start and stop

Power cables



Hi-flex Power cables for use in cable carriers

- Power supply of electrical applications and electric drives
- Transmission of large electrical currents

High voltage cables



Hi-flex High Voltage Power cables for use in cable carriers

- High Voltage power supply of heavy duty applications and drives
- High current flow
- Single core

BUS cables



Hi-flex BUS cables for use in cable carriers

- Network
- Communication with several participants

Coaxial cables



Hi-flex Coax cables for use in cable carriers

- Transmission of video and audio signals

Data cables



Hi-flex Data cables for use in cable carriers

- Network
- Communication between transmitter and receiver
- Transmission of information

Fiber optic cables



Hi-flex Fiber optic cables for use in cable carriers

- EMC-save data Transmission
- very high data rate with speed of light
- metalfree

OEM cables



Hi-flex Servo & Feedback cables for use in cable carriers

- Supply and control of servo drives
- OEM quality

Assembled cables



You need connection-ready harnessed bus cables?

Or harnessed signal- or power cables for drives – in accordance to OEM specifications?

tsubaki-kabelschlepp.com

Technical support:
technik@kabelschlepp.de

Definition
from page 164

































Technical Information
from page 178

Technical support:
Fon: +49 (0)2762 4003-0

 online-engineer.de
Cable Carrier Configurator

Series	Cable type	Outer jacket	Shield	Factor for KR _{min} = n x Ø cable	Temperature moved
Control cables					
	CONTROL 200	PVC	–	10	-5 to +80 °C
	CONTROL 200 C	PVC	•	10	-5 bis +80 °C
	CONTROL 400 600 V	PVC	–	7.5	-5 to +80 °C
	CONTROL 400 C 600 V	PVC	•	7.5	-5 to +80 °C
	CONTROL 700 600 V	PUR	–	7.5	-35 to +90 °C
	CONTROL 700 C 600 V	PUR	•	7.5	-35 to +90 °C
	CONTROL 1000 C TPE 300/500 V	TPE	–	5	-35 to +90 °C
	CONTROL 1000 TPE 300/500 V	TPE	•	5	-35 to +90 °C
Power cables Multiple and single core lines					
	POWER 400 1 kV	PVC	–	7.5	-5 to +80 °C
	POWER 400 C 1 kV	PVC	•	7.5	-5 to +80 °C
	POWER 700 1 kV	PUR	–	7.5	-35 to +90 °C
	POWER 700 C 1 kV	PUR	•	7.5	-35 to +90 °C
	POWER 1000 TPE 1 kV	TPE	–	5	-35 to +90 °C
	POWER 1000 C TPE 1 kV	TPE	•	5	-35 to +90 °C
	POWER ONE 700 1 kV	PUR	–	7.5	-35 to +90 °C
	POWER ONE 700 C 1 kV	PUR	•	7.5	-35 to +90 °C
	POWER ONE 700 PE	PUR	–	7.5	-35 to +90 °C
	POWER ONE 1000 TPE 1 kV	TPE	–	5	-35 to +90 °C
	POWER ONE 1000 C TPE 1 kV	TPE	•	5	-35 to +90 °C

TRAXLINE® | Cable carrier cable range

Approvals	Standards	Color type-dependent	Halogen-free	Flame-retardant	Oil-resistant	V _{max} supported [m/s]	V _{max} gliding [m/s]	a _{max} [m/s ²]	Diameter mm ² /Type/Other	Core number	Page
C  US	 REACH/RoHS II	Black	–	•	•	3.5	2	10	0.5 ² to 2.5 ²	3-25	20
C  US	 REACH/RoHS II	Black	–	•	•	3.5	2	10	0.5 ² to 1.5 ²	3-25	22
C  US	 REACH/RoHS II	Black	–	•	•	5	3	20	0.5 ² to 2.5 ²	3-48	24
C  US	 REACH/RoHS II	Black	–	•	•	5	5	20	0.5 ² to 1.5 ²	3-36	26
C  US	 REACH/RoHS II	Black	•	•	•	20	5	50	0.5 ² to 1 ²	2-49	28
C  US	 REACH/RoHS II	Black	•	•	•	20	5	50	0.5 ² to 1 ²	3-49	30
	 REACH/RoHS II	Black	•	–	•	20	5	50	0.5 ² to 1 ²	12-36	32
	 REACH/RoHS II	Black	•	–	•	20	5	50	0.5 ² to 1 ²	12-49	34
C  US	 REACH/RoHS II	Black	–	•	•	5	3	20	1.5 ² to 70 ²	3-25	38
C  US	 REACH/RoHS II	Black	–	•	•	5	5	20	1.5 ² to 35 ²	4-7	40
C  US	 REACH/RoHS II	Black	•	•	•	20	5	50	1.5 ² to 95 ²	3-36	42
C  US	 REACH/RoHS II	Black	•	•	•	20	5	50	1.5 ² to 150 ²	2-49	44
	 REACH/RoHS II	Black	•	–	•	20	5	50	2.5 ² to 95 ²	4-25	46
	 REACH/RoHS II	Black	•	–	•	20	5	50	2.5 ² to 150 ²	4-5	48
C  US	 REACH/RoHS II	Black	•	•	•	20	5	50	0.25 ² to 700 ²	1	50
C  US	 REACH/RoHS II	Black	•	•	•	20	5	50	1.5 ² to 300 ²	1	52
C  US	 REACH/RoHS II	Black	•	•	•	20	5	50	1.5 ² to 240 ²	1	54
	 REACH/RoHS II	Black	•	–	•	20	5	50	2.5 ² to 300 ²	1	56
	 REACH/RoHS II	Black	•	–	•	20	5	50	4 ² to 300 ²	1	58

More information:
traxline.de

tsubaki-kabelschlepp.com



















Technical support:
technik@kabelschlepp.de

Definition
from page 164

Technical Information
from page 178

Technical support:
Fon: +49 (0)2762 4003-0

online-engineer.de
Cable Carrier Configurator

Series	Cable type	Outer jacket	Shield	Factor for KR _{min} = n x Ø cable	Temperature moved
High voltage cables Single core lines					
	POWER ONE HEAVY DUTY 6/10 kV	PUR	•	7.5	-35 to +80 °C
	POWER ONE HEAVY DUTY 6.7/11 kV	PUR	•	7.5	-35 to +80 °C
	POWER ONE HEAVY DUTY 7.2/12 kV	PUR	•	7.5	-35 to +80 °C
Data cables					
	DATA 400 C	PVC	•	7.5	-5 to +80 °C
	DATA 700	PUR	–	7.5	-35 to +90 °C
	DATA 700 TPI C	PUR	•	7.5	-35 to +90 °C
	DATA 700 TPI CD	PUR	•	7.5	-35 to +90 °C
	DATA 700 TPI CD 1 kV	PUR	•	7.5	-35 to +90 °C
	DATA 1000 TPI C TPE	TPE	•	5	-35 to +90 °C
BUS cables					
	PROFIBUS 700 CD	PUR	•	15	-40 to +70 °C
	PROFIBUS 700 CD 90°C	PUR	•	15	-20 to +90 °C
	PROFINET 700 CD	PUR	•	15	-30 to +70 °C
	CAN-BUS 700 C	PUR	•	7.5	-30 to +80 °C
	USB 2.0 S 700 CD	PUR	•	10	-10 to +70 °C
	USB 2.0 L 700 CD	PUR	•	10	-10 to +70 °C
	USB 3.0 700 CD	PUR	•	10	-10 to +70 °C
	CAT.5E 700 CD	PUR	•	7.5	-30 to +80 °C
	CAT.6 700 CD	PUR	•	7.5	-30 to +80 °C

TRAXLINE® | Cable carrier cable range

Approvals	Standards	Color type-dependent	Halogen-free	Flame-retardant	Oil-resistant	V _{max} supported [m/s]	V _{max} gliding [m/s]	a _{max} [m/s ²]	Diameter mm ² /Type/Other	Core number	Page
	CE REACH/RoHS II	Red	•	•	•	10	6	50	10 ² to 400 ²	1	62
	CE REACH/RoHS II	Red	•	•	•	10	6	50	10 ² to 400 ²	1	64
	CE REACH/RoHS II	Red	•	•	•	10	6	50	10 ² to 400 ²	1	66
C _{RU} US	CE REACH/RoHS II	Black	–	•	•	5	5	50	0.25 ² to 0.34 ²	4-25	70
C _{RU} US	CE REACH/RoHS II	Black	•	•	•	20	5	50	0.25 ² to 0.34 ²	3-15	72
C _{RU} US	CE REACH/RoHS II	Black	•	•	•	20	5	50	0.25 ² to 0.75 ²	2-32	74
C _{RU} US	CE REACH/RoHS II	Black	•	•	•	20	5	50	0.25 ² to 0.5 ²	6-32	76
C _{RU} US	CE REACH/RoHS II	Black	•	•	•	20	5	50	1.5 ²	4-20	78
	CE REACH/RoHS II	Black	•	–	•	20	5	50	0.25 ² to 0.75 ²	2-32	80
C _{RU} US	CE REACH/RoHS II	Violet	•	•	•	3.5	2	10	0.64 mm	2	84
C _{RU} US	CE REACH/RoHS II	Violet	•	•	•	3.5	2	10	0.64 mm	2	86
C _{RU} US	CE REACH/RoHS II	Green	•	•	•	3.5	2	10	AWG 22	4	88
C _{RU} US	CE REACH/RoHS II	Black	•	•	•	3	3	10	0.5 ²	2-4	90
C _{RU} US	CE REACH/RoHS II	Violet	•	•	•	3.5	2	10	AWG 28 / 20	4	92
C _{RU} US	CE REACH/RoHS II	Black	•	•	•	3.5	2	10	AWG 24 / 20	4	94
C _{RU} US	CE REACH/RoHS II	Violet	•	•	•	3.5	2	10	AWG 28	8	96
C _{RU} US	CE REACH/RoHS II	Green	•	•	•	3	3	5	AWG 26	8	98
C _{RU} US	CE REACH/RoHS II	Green	•	•	•	3	3	5	AWG 26	8	100

More information:
traxline.de

tsubaki-kabelschlepp.com

Technical support:
technik@kabelschlepp.de

Definition
from page 164





Technical Information
from page 178

Technical support:
Fon: +49 (0)2762 4003-0

online-engineer.de
Cable Carrier Configurator

Series	Cable type	Outer jacket	Shield	Factor for KR _{min} = n x Ø cable	Temperature moved
--------	------------	--------------	--------	---	-------------------





Coaxial cables

	KOAX 700 C 50 Ohm	PUR	•	15	-20 to +70 °C
	KOAX 700 C 75 Ohm	PUR	•	15	-20 to +70 °C
	KOAX 700 CD 50 Ohm	PUR	•	15	-20 to +70 °C
	KOAX 700 CD 75 Ohm	PUR	•	15	-20 to +70 °C







Fiber optic cables

	FOC 700	PUR	–	7.5	-30 to +90 °C
---	---------	-----	---	-----	---------------

OEM cables

	SYSTEM M 700 C	PUR	•	7.5	-35 to +90 °C
	SYSTEM M 700 CD	PUR	•	7.5	-35 to +90 °C
	SYSTEM S 700 C	PUR	•	7.5	-35 to +90 °C
	SYSTEM S 700 CD	PUR	•	7.5	-35 to +90 °C

Assembled cables

	Power cables according to Siemens				128
	Signal cables according to Siemens				139
	Power cables according to Bosch Rexroth				142
	Signal cables according to Bosch Rexroth				145
	Power cables according to LENZE				147
	Signal cables according to LENZE				150







Approvals	Standards	Color type-dependent	Halogen-free	Flame-retardant	Oil-resistant	V _{max} supported [m/s]	V _{max} gliding [m/s]	a _{max} [m/s ²]	Diameter mm ² /Type/Other	Core number	Page
	CE REACH/RoHS II	Black	•	•	•	3	3	3	1	1-5	104
	CE REACH/RoHS II	Black	•	•	•	3	3	3	1	1-5	106
	CE REACH/RoHS II	Black	•	•	•	3	3	3	3-5	1-5	108
	CE REACH/RoHS II	Black	•	•	•	3	3	3	3-5	1-5	110
	CE REACH/RoHS II	Black	•	•	–	3.5	3.5	10	50µ/62.5µ	6-12	114
UL US	CE REACH/RoHS II	Orange	•	•	•	5	5	50	1.5 ² to 50 ²	8	118
UL US	CE REACH/RoHS II	Orange	•	•	•	5	5	50	0.75 ² to 1.5 ²	6-8	120
UL US	CE REACH/RoHS II	Green	•	•	•	5	5	50	0.14 ² to 1 ²	2-12	122
UL US	CE REACH/RoHS II	Green	•	•	•	5	5	50	0.14 ² to 1 ²	5-13	124

More information:
traxline.de

tsubaki-kabelschlepp.com

Technical support:
technik@kabelschlepp.de

Assembled cables

	Power cables according to SEW	151
	Signal cables according to SEW	156
	Other OEM assembled cables	158
	Assembled USB cables	160
	Assembled CAT cables	161
	Assembled KOAX cables	162
	Assembled FOC cables	163

TRAXLINE®

Control cables



Trademarks are legally protected for the TSJ/D4K1
KABELSCHLEPP GmbH as a national or international
registration in the following countries:
tsj@kabelschlepp.com/trademarks

Subject to change.

CONTROL 200

Page 20



Outer jacket: PVC
Shield: Unshielded
Flexibility: bending flexible
Demands: flexing/
demanding

Up to motion cycles: 2 Million
Travel length up to: 25 m

CONTROL 200 C

Page 22



Outer jacket: PVC
Shield: Shielded
Flexibility: bending flexible
Demands: flexing/
demanding

Up to motion cycles: 2 Million
Travel length up to: 25 m

CONTROL 400 600 V

Page 24



Outer jacket: PVC
Shield: Unshielded
Flexibility: hi-flex
Demands: demanding/
high demanding

Up to motion cycles: 4 Million
Travel length up to: 100 m

CONTROL 400 C 600 V

Page 26



Outer jacket: PVC
Shield: Shielded
Flexibility: hi-flex
Demands: demanding/
high demanding

Up to motion cycles: 4 Million
Travel length up to: 100 m

CONTROL 700 600 V

Page 28



Outer jacket: PUR
Shield: Unshielded
Flexibility: hi-flex
Demands: high demanding

Up to motion cycles: 7 Million
Travel length up to: 500 m

CONTROL 700 C 600 V

Page 30



Outer jacket: PUR
Shield: Shielded
Flexibility: hi-flex
Demands: high demanding

Up to motion cycles: 7 Million
Travel length up to: 500 m

CONTROL 1000 TPE 300/500 V

Page 32



Outer jacket: TPE
Shield: Unshielded
Flexibility: hi-flex
Demands: very high
demanding

Up to motion cycles: 10 Million
Travel length up to: 1000 m

CONTROL 1000 C TPE 300/500 V

Page 34



Outer jacket: TPE
Shield: Shielded
Flexibility: hi-flex
Demands: very high
demanding

Up to motion cycles: 10 Million
Travel length up to: 1000 m

TRAXLINE® CONTROL 200

Unshielded continuous bending hi-flex PVC control cables

Definition
from page 164Technical Information
from page 178Technical support:
Fon: +49 (0)2762 4003-0online-engineer.de
Cable Carrier ConfiguratorLAYER STRANDING :
Concentric stranding in layers**PVC OUTER JACKET**pressure-extruded, hi-flex design,
high abrasion resistant**PP CORE INSULATION**hi-flex design,
low capacitance

Picture obtainable.

Up to **2 Million**
Motion cyclesUp to **25 m**
Travel length

General information

- Communication between transmitter and receiver
- Logical state of 0 and 1 control
- Signal for turning on and off/start and stop
- Outer jacket valley-sealed extruded and high abrasion resistant

Norms and standards

- Oil-resistant
- UV-resistant
- Ozone-resistant
- Silicone-free
- CFC-free
- REACH/RoHS II
- Flame-retardant

Design

Conductor:	Class 5
Core insulation:	PP/9Y
Core identification:	Black, coded with white numbers, 1 x ye/gn
Core stranding:	Conductor cores layered
Shield:	Unshielded
Jacket color:	Black
Outer jacket:	PVC

Technical data

Temperature range while moved:	-5 up to +80 °C (-5 up to +80 °C UL)
Minimum bend radius while moved:	$KR_{min} \geq 10 \times \emptyset$
V_{max} supported:	3.5 m/s
V_{max} gliding:	2 m/s
a_{max} supported:	10 m/s ²
a_{max} gliding:	10 m/s ²
Insulation resistance:	> 30 MΩ x km
Nominal voltage control core(s):	according to VDE 0.30/0.50 kV according to UL 0.30 kV

Varying parameters possible

TRAXLINE® CONTROL 200 – Unshielded

Core number x Cross-section [mm ²]	Part no.	max. Ø [mm]	Cable weight [kg/m]	Copper weight [kg/m]
3 G 0.5 ²	47352	4.7	0.031	0.014
4 G 0.5 ²	47353	5.1	0.037	0.019
5 G 0.5 ²	47354	5.5	0.045	0.024
7 G 0.5 ²	47356	6.5	0.062	0.034
12 G 0.5 ²	47360	7.6	0.090	0.058
18 G 0.5 ²	47364	9.0	0.131	0.086
25 G 0.5 ²	47367	11.4	0.195	0.120
3 G 0.75 ²	47372	5.5	0.043	0.022
4 G 0.75 ²	47373	6.1	0.055	0.029
5 G 0.75 ²	47374	6.6	0.066	0.036
7 G 0.75 ²	47376	7.7	0.088	0.050
12 G 0.75 ²	47380	9.3	0.134	0.086
18 G 0.75 ²	47384	11.2	0.197	0.130
25 G 0.75 ²	47387	13.9	0.290	0.180
3 G 1 ²	47392	6.0	0.054	0.029
4 G 1 ²	47393	6.5	0.067	0.038
5 G 1 ²	47394	7.0	0.079	0.048
7 G 1 ²	47396	8.3	0.109	0.067
12 G 1 ²	47400	10.2	0.168	0.115
18 G 1 ²	47404	12.2	0.243	0.173
25 G 1 ²	47407	15.1	0.363	0.240
3 G 1.5 ²	47412	6.6	0.071	0.043
4 G 1.5 ²	47413	7.1	0.087	0.058
5 G 1.5 ²	47414	7.7	0.105	0.072
7 G 1.5 ²	47416	9.2	0.144	0.101
12 G 1.5 ²	47420	11.5	0.230	0.173
18 G 1.5 ²	47424	13.4	0.330	0.259
25 G 1.5 ²	47427	16.8	0.491	0.360
4 G 2.5 ²	47433	8.9	0.141	0.096

Additional types upon request.



Cable+Connector
ready to connection

More information:
traxline.de

tsubaki-kabelschlepp.com

Technical support:
technik@kabelschlepp.de

TRAXLINE® CONTROL 200 C

Shielded continuous bending hi-flex PVC control cables

Definition
from page 164



Picture obtainable.

Technical Information
from page 178



Up to **2 Million**
Motion cycles



Up to **25 m**
Travel length



Technical support:
Fon: +49 (0)2762 4003-0

General information

- Communication between transmitter and receiver
- Logical state of 0 and 1 control
- Signal for turning on and off/start and stop
- Good EMC-protection by overall-shield
- Outer jacket pressure extruded and high abrasion resistant
- Inner jacket valley-sealed extruded

Norms and standards

- Oil-resistant
- UV-resistant
- Ozone-resistant
- Silicone-free
- CFC-free
- REACH/RoHS II
- Flame-retardant

Design

Conductor:	Class 5
Core insulation:	PP/9Y
Core identification:	Black, coded with white numbers, 1 x ye/gn
Core stranding:	Conductor cores layered
Inner jacket:	PVC
Shield:	Shielded
Jacket color:	Black
Outer jacket:	PVC

Technical data

Temperature range while moved:	-5 up to +80 °C (-5 up to +80 °C UL)
Minimum bend radius while moved:	$KR_{min} \geq 10 \times \emptyset$
V_{max} supported:	3.5 m/s
V_{max} gliding:	2 m/s
a_{max} supported:	10 m/s ²
a_{max} gliding:	10 m/s ²
Insulation resistance:	> 30 MΩ x km
Nominal voltage control core(s):	according to VDE 0.30/0.50 kV according to UL 0.30 kV

Varying parameters possible

Control cables | Type selection

TRAXLINE® CONTROL 200 C – Shielded

Core number x Cross-section [mm ²]	Part no.	max. Ø [mm]	Cable weight [kg/m]	Copper weight [kg/m]
(3 G 0.5 ²)	47652	6.4	0.062	0.036
(4 G 0.5 ²)	47653	6.8	0.070	0.042
(5 G 0.5 ²)	47654	7.2	0.081	0.048
(7 G 0.5 ²)	47656	8.2	0.104	0.064
(12 G 0.5 ²)	47660	9.7	0.149	0.105
(18 G 0.5 ²)	47664	11.0	0.194	0.137
(25 G 0.5 ²)	47667	13.6	0.283	0.210
(3 G 0.75 ²)	47672	7.2	0.079	0.048
(4 G 0.75 ²)	47673	7.6	0.090	0.055
(5 G 0.75 ²)	47674	8.3	0.108	0.066
(7 G 0.75 ²)	47676	9.8	0.147	0.085
(12 G 0.75 ²)	47680	11.3	0.198	0.135
(18 G 0.75 ²)	47684	13.4	0.284	0.190
(25 G 0.75 ²)	47687	16.5	0.416	0.275
(3 G 1 ²)	47692	7.7	0.091	0.059
(4 G 1 ²)	47693	8.2	0.108	0.070
(5 G 1 ²)	47694	8.7	0.124	0.084
(7 G 1 ²)	47696	10.4	0.167	0.106
(12 G 1 ²)	47700	12.1	0.232	0.174
(18 G 1 ²)	47704	14.2	0.334	0.240
(25 G 1 ²)	47707	17.5	0.486	0.332
(3 G 1.5 ²)	47712	8.3	0.113	0.075
(4 G 1.5 ²)	47713	8.8	0.133	0.090
(5 G 1.5 ²)	47714	9.8	0.163	0.108
(7 G 1.5 ²)	47716	11.2	0.207	0.157
(12 G 1.5 ²)	47720	13.7	0.318	0.240
(18 G 1.5 ²)	47724	15.8	0.440	0.355
(25 G 1.5 ²)	47727	19.6	0.646	0.448

Additional types upon request.



Cable+Connector
ready to connection

More information:
traxline.de

tsubaki-kabelschlepp.com

Technical support:
technik@kabelschlepp.de

TRAXLINE® CONTROL 400 600 V

Unshielded continuous bending hi-flex PVC control cables

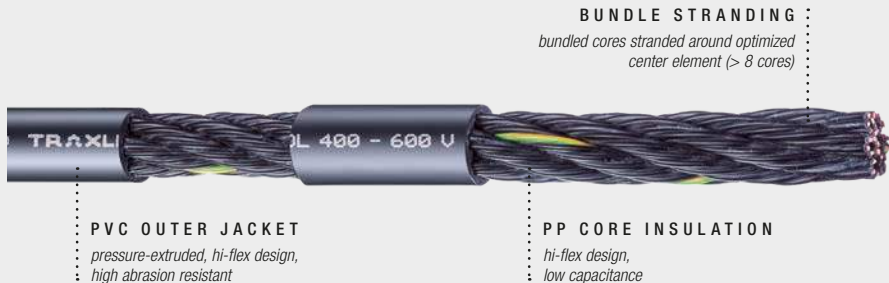
Definition
from page 164Technical Information
from page 178Technical support:
Fon: +49 (0)2762 4003-0online-engineer.de
Cable Carrier Configurator

Picture obtainable.

Up to **4 Million**
Motion cyclesUp to **100 m**
Travel length

General information

- Communication between transmitter and receiver
- Logical state of 0 and 1 control
- Signal for turning on and off/start and stop
- Outer jacket valley-sealed extruded and high abrasion resistant

Norms and standards

- Oil-resistant
- UV-resistant
- Ozone-resistant
- Silicone-free
- CFC-free
- REACH/RoHS II
- Flame-retardant

Design

Conductor:	Class 6
Core insulation:	PP/9Y
Core identification:	Black, coded with white numbers, 1 x ye/gn
Core stranding:	Bundle stranded (> 8 cores) Layer stranded (≤ 8 cores)
Shield:	Unshielded
Jacket color:	Black
Outer jacket:	PVC

Technical data

Temperature range while moved:	-5 up to +80 °C (-5 up to +80 °C UL)
Minimum bend radius while moved:	KR _{min} ≥ 7.5 x Ø
V_{max} supported:	5 m/s
V_{max} gliding:	3 m/s
a_{max} supported:	20 m/s ²
a_{max} gliding:	20 m/s ²
Insulation resistance:	> 30 MΩ x km
Nominal voltage control core(s):	according to VDE 0.30/0.50 kV according to UL 0.60 kV

Varying parameters possible

Control cables | Type selection

TRAXLINE® CONTROL 400 600 V – Unshielded

Core number x Cross-section [mm ²]	Part no.	max. Ø [mm]	Cable weight [kg/m]	Copper weight [kg/m]
3 G 0.5 ²	48111	6.1	0.047	0.014
4 G 0.5 ²	48112	6.6	0.057	0.019
5 G 0.5 ²	48113	7.0	0.063	0.025
7 G 0.5 ²	48115	8.1	0.088	0.034
12 G 0.5 ²	48119	10.7	0.145	0.063
18 G 0.5 ²	48121	12.7	0.199	0.087
25 G 0.5 ²	48124	14.4	0.267	0.130
30 G 0.5 ²	48125	15.9	0.324	0.155
36 G 0.5 ²	48126	17.5	0.404	0.185
48 G 0.5 ²	48128	21.0	0.524	0.260
4 G 0.75 ²	48040	7.2	0.068	0.029
5 G 0.75 ²	48041	7.8	0.082	0.036
7 G 0.75 ²	48042	8.9	0.106	0.051
12 G 0.75 ²	48043	12.1	0.183	0.088
18 G 0.75 ²	48044	14.5	0.268	0.138
25 G 0.75 ²	48045	16.6	0.362	0.195
3 G 1 ²	48046	6.9	0.065	0.029
4 G 1 ²	48047	7.6	0.081	0.039
5 G 1 ²	48048	8.2	0.097	0.050
7 G 1 ²	48049	9.4	0.127	0.068
12 G 1 ²	48050	12.7	0.212	0.125
18 G 1 ²	48051	15.4	0.322	0.187
25 G 1 ²	48052	17.7	0.438	0.260
3 G 1.5 ²	48053	7.8	0.086	0.045
4 G 1.5 ²	48054	7.8	0.095	0.058
5 G 1.5 ²	48055	8.5	0.115	0.072
7 G 1.5 ²	48056	10.8	0.171	0.101
12 G 1.5 ²	48057	14.7	0.303	0.174
18 G 1.5 ²	48058	18.0	0.462	0.280
25 G 1.5 ²	48059	20.7	0.588	0.360
4 G 2.5 ²	48060	9.7	0.152	0.096

Additional types upon request.



TRAXLINE® CONTROL 400 C 600 V

Shielded continuous bending hi-flex PVC control cables

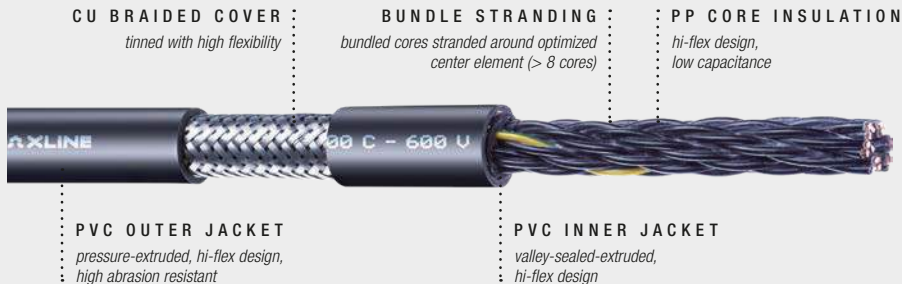
Definition
from page 164

Picture obtainable.

Technical Information
from page 178Up to **4 Million**
Motion cyclesUp to **100 m**
Travel length

Technical support:

Fon: +49 (0)2762 4003-0

Cable Carrier Configurator

General information

- Communication between transmitter and receiver
- Logical state of 0 and 1 control
- Signal for turning on and off/start and stop
- Good EMC-protection by overall-shield
- Outer jacket pressure extruded and high abrasion resistant
- Inner jacket valley-sealed extruded

Design

Conductor:	Class 6
Core insulation:	PP/9Y
Core identification:	Black, coded with white numbers, 1 x ye/gn
Core stranding:	Bundle stranded (> 8 cores) Layer stranded (≤ 8 cores)
Inner jacket:	PVC
Shield:	Shielded
Jacket color:	Black
Outer jacket:	PVC

Norms and standards

- Oil-resistant
- UV-resistant
- Ozone-resistant
- Silicone-free
- CFC-free
- REACH/RoHS II
- Flame-retardant

Technical data

Temperature range while moved:	-5 up to +80 °C (-5 up to +80 °C UL)
Minimum bend radius while moved:	$KR_{min} \geq 7.5 \times \emptyset$
V_{max} supported:	5 m/s
V_{max} gliding:	5 m/s
a_{max} supported:	20 m/s ²
a_{max} gliding:	20 m/s ²
Insulation resistance:	> 30 MΩ x km
Nominal voltage control core(s):	according to VDE 0.30/0,50 kV according to UL 0.60 kV

Varying parameters possible

Control cables | Type selection

TRAXLINE® CONTROL 400 C 600 V – Shielded

Core number x Cross-section [mm ²]	Part no.	max. Ø [mm]	Cable weight [kg/m]	Copper weight [kg/m]
(5 G 0.5 ²)	48664	8.7	0.110	0.052
(7 G 0.5 ²)	48666	9.8	0.136	0.066
(9 G 0.5 ²)	48668	11.2	0.172	0.090
(12 G 0.5 ²)	48670	12.7	0.220	0.106
(18 G 0.5 ²)	48674	15.1	0.302	0.169
(25 G 0.5 ²)	48678	17.2	0.405	0.223
(30 G 0.5 ²)	48679	18.9	0.473	0.272
(36 G 0.5 ²)	48680	20.6	0.552	0.302
(3 G 0.75 ²)	48682	8.3	0.095	0.045
(4 G 0.75 ²)	48070	8.9	0.111	0.055
(7 G 0.75 ²)	48071	10.9	0.164	0.085
(12 G 0.75 ²)	48072	14.3	0.278	0.151
(18 G 0.75 ²)	48073	17.1	0.379	0.225
(25 G 0.75 ²)	48074	19.6	0.516	0.295
(4 G 1 ²)	48075	9.3	0.128	0.073
(7 G 1 ²)	48076	11.4	0.190	0.115
(12 G 1 ²)	48077	15.1	0.319	0.198
(18 G 1 ²)	48078	18.2	0.447	0.272
(25 G 1 ²)	48079	20.8	0.596	0.357
(4 G 1.5 ²)	48080	10.4	0.161	0.085
(5 G 1.5 ²)	48081	11.1	0.184	0.103
(7 G 1.5 ²)	48082	12.9	0.249	0.148
(12 G 1.5 ²)	48083	17.3	0.425	0.269
(18 G 1.5 ²)	48084	20.9	0.601	0.382
(25 G 1.5 ²)	48085	23.9	0.802	0.503
(30 G 1.5 ²)	48086	26.7	0.977	0.635

Additional types upon request.



Cable+Connector
ready to connection

More information:
traxline.de

tsubaki-kabelschlepp.com

Technical support:
technik@kabelschlepp.de

TRAXLINE® CONTROL 700 600 V

Unshielded continuous bending hi-flex PUR control cables

Definition
from page 164Technical Information
from page 178Technical support:
Fon: +49 (0)2762 4003-0online-engineer.de
Cable Carrier Configurator

Picture obtainable.

Up to **7 Million**
Motion cyclesUp to **500 m**
Travel length

General information

- Communication between transmitter and receiver
- Logical state of 0 and 1 control
- Signal for turning on and off/start and stop
- Outer jacket valley-sealed extruded and high abrasion resistant

Norms and standards

- Oil-resistant
- UV-resistant
- Ozone-resistant
- Silicone-free
- CFC-free
- REACH/RoHS II
- Flame-retardant
- NEK 606
- Halogen-free

Design

Conductor:	Class 6
Core insulation:	PP/9Y
Core identification:	Black, coded with white numbers, 1 x ye/gn
Core stranding:	Bundle stranded (> 8 cores) Layer stranded (≤ 8 cores)
Shield:	Unshielded
Jacket color:	Black
Outer jacket:	PUR

Technical data

Temperature range while moved:	-35 up to +90 °C (-35 up to +80 °C UL)
Minimum bend radius while moved:	KR _{min} ≥ 7.5 x Ø
V_{max} supported:	20 m/s
V_{max} gliding:	5 m/s
a_{max} supported:	50 m/s ²
a_{max} gliding:	50 m/s ²
Insulation resistance:	> 30 MΩ x km
Nominal voltage control core(s):	according to VDE 0.30/0.50 kV according to UL 0.60 kV

Varying parameters possible

Control cables | Type selection

TRAXLINE® CONTROL 700 600 V – Unshielded

Core number x Cross-section [mm ²]	Part no.	max. Ø [mm]	Cable weight [kg/m]	Copper weight [kg/m]
2 x 0.5 ²	45391	5.8	0.039	0.010
3 G 0.5 ²	45392	6.1	0.045	0.014
4 G 0.5 ²	45393	6.6	0.053	0.020
7 G 0.5 ²	45396	8.1	0.085	0.035
12 G 0.5 ²	45400	10.7	0.139	0.060
15 G 0.5 ²	45401	11.7	0.162	0.072
16 G 0.5 ²	45402	12.0	0.178	0.077
36 G 0.5 ²	45412	18.2	0.392	0.198
49 G 0.5 ²	45415	21.8	0.539	0.236
3 G 0.75 ²	45421	6.6	0.055	0.023
4 G 0.75 ²	45422	7.2	0.069	0.031
5 G 0.75 ²	45423	7.8	0.083	0.038
7 G 0.75 ²	45425	9.0	0.108	0.053
12 G 0.75 ²	45429	11.9	0.181	0.096
18 G 0.75 ²	45431	14.3	0.257	0.146
25 G 0.75 ²	45434	16.3	0.362	0.209
36 G 0.75 ²	45436	20.2	0.517	0.270
3 G 1 ²	45441	7.0	0.067	0.029
4 G 1 ²	45442	7.6	0.082	0.044
5 G 1 ²	45443	8.2	0.097	0.048
7 G 1 ²	45445	9.5	0.125	0.070
8 G 1 ²	45446	10.3	0.145	0.077
12 G 1 ²	45449	12.7	0.216	0.125
18 G 1 ²	45451	15.4	0.315	0.210
25 G 1 ²	45454	17.7	0.437	0.302

Additional types upon request.



Cable+Connector
ready to connection

TRAXLINE® CONTROL 700 C 600 V

Shielded continuous bending hi-flex PUR control cables

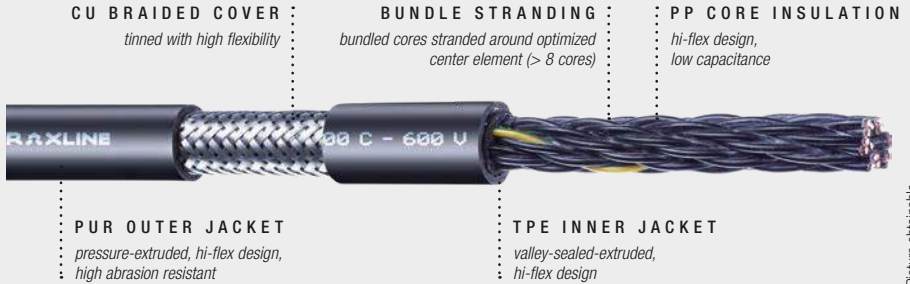
Definition
from page 164Technical Information
from page 178Up to **7 Million**
Motion cyclesUp to **500 m**
Travel lengthTechnical support:
Fon: +49 (0)2762 4003-0**General information**

- Communication between transmitter and receiver
- Logical state of 0 and 1 control
- Signal for turning on and off/start and stop
- Good EMC-protection by overall-shield
- Outer jacket pressure extruded and high abrasion resistant
- Inner jacket valley-sealed extruded

Norms and standards

- Oil-resistant
- UV-resistant
- Ozone-resistant
- Silicone-free
- CFC-free
- REACH/RoHS II
- Flame-retardant
- NEK 606
- Halogen-free

Design

Conductor:	Class 6
Core insulation:	PP/9Y
Core identification:	Black, coded with white numbers, 1 x ye/gn
Core stranding:	Bundle stranded (> 8 cores) Layer stranded (≤ 8 cores)
Inner jacket:	TPE
Shield:	Shielded
Jacket color:	Black
Outer jacket:	PUR

Technical data

Temperature range while moved:	-35 up to +90 °C (-35 up to +80 °C UL)
Minimum bend radius while moved:	$KR_{min} \geq 7.5 \times \emptyset$
V_{max} supported:	20 m/s
V_{max} gliding:	5 m/s
a_{max} supported:	50 m/s ²
a_{max} gliding:	50 m/s ²
Insulation resistance:	> 30 MΩ x km
Nominal voltage control core(s):	according to VDE 0.30/0.50 kV according to UL 0.60 kV

Varying parameters possible

TRAXLINE® CONTROL 700 C 600 V – Shielded

Core number x Cross-section [mm ²]	Part no.	max. Ø [mm]	Cable weight [kg/m]	Copper weight [kg/m]
(3 G 0.5 ²)	45701	7.9	0.081	0.036
(4 G 0.5 ²)	45702	8.4	0.090	0.042
(5 G 0.5 ²)	45703	8.9	0.103	0.048
(7 G 0.5 ²)	45705	10.0	0.130	0.064
(12 G 0.5 ²)	45709	12.7	0.201	0.109
(18 G 0.5 ²)	45712	15.1	0.268	0.167
(25 G 0.5 ²)	45715	17.2	0.360	0.212
(3 G 0.75 ²)	45721	8.4	0.082	0.048
(4 G 0.75 ²)	45722	9.0	0.109	0.055
(5 G 0.75 ²)	45723	9.6	0.126	0.066
(7 G 0.75 ²)	45725	11.0	0.158	0.087
(12 G 0.75 ²)	45729	14.3	0.256	0.147
(18 G 0.75 ²)	45732	16.6	0.348	0.222
(25 G 0.75 ²)	45735	19.7	0.491	0.293
(3 G 1 ²)	45741	8.8	0.104	0.059
(4 G 1 ²)	45742	9.4	0.123	0.070
(5 G 1 ²)	45743	10.0	0.139	0.084
(7 G 1 ²)	45745	11.6	0.183	0.106
(12 G 1 ²)	45749	15.1	0.297	0.174
(18 G 1 ²)	45752	18.3	0.429	0.240
(25 G 1 ²)	45755	20.6	0.550	0.332
(36 G 1 ²)	45757	25.3	0.803	0.346
(49 G 1 ²)	45759	29.9	1.114	0.471

Additional types upon request.



More information:
traxline.de

tsubaki-kabelschlepp.com

Technical support:
technik@kabelschlepp.de

TRAXLINE® CONTROL 1000 TPE 300/500 V

Unshielded continuous bending hi-flex TPE control cables

Definition
from page 164Technical Information
from page 178Technical support:
Fon: +49 (0)2762 4003-0online-engineer.de
Cable Carrier Configurator

Picture obtainable.

Up to **10 Million**
Motion cyclesUp to **1000 m**
Travel length**General information**

- Communication between transmitter and receiver
- Logical state of 0 and 1 control
- Signal for turning on and off/start and stop
- Outer jacket valley-sealed extruded and high abrasion resistant

Norms and standards

- Oil-resistant
- UV-resistant
- Ozone-resistant
- Silicone-free
- CFC-free
- REACH/RoHS II
- Halogen-free

Design

Conductor:	Class 6
Core insulation:	PP/9Y
Core identification:	Black, coded with white numbers, 1 x ye/gn
Core stranding:	Bundle stranded (> 8 cores) Layer stranded (≤ 8 cores)
Shield:	Unshielded
Jacket color:	Black
Outer jacket:	TPE

Technical data

Temperature range while moved:	-35 up to +90 °C
Minimum bend radius while moved:	KR _{min} ≥ 5 x Ø
V_{max} supported:	20 m/s
V_{max} gliding:	5 m/s
a_{max} supported:	50 m/s ²
a_{max} gliding:	50 m/s ²
Insulation resistance:	> 30 MΩ x km
Nominal voltage control core(s):	according to VDE 0.30/0.50 kV

Varying parameters possible

TRAXLINE® CONTROL 1000 TPE 300/500 V – Unshielded

Core number x Cross-section [mm ²]	Part no.	max. Ø [mm]	Cable weight [kg/m]	Copper weight [kg/m]
12 G 0.5 ²	49400	9.6	0.108	0.060
15 G 0.5 ²	49401	11.7	0.170	0.072
16 G 0.5 ²	49402	12.0	0.186	0.077
36 G 0.5 ²	49412	17.5	0.389	0.198
12 G 0.75 ²	49429	12.1	0.183	0.096
18 G 0.75 ²	49431	14.3	0.252	0.146
25 G 0.75 ²	49434	16.6	0.354	0.209
36 G 0.75 ²	49436	20.2	0.505	0.270
12 G 1 ²	49449	12.7	0.216	0.125
18 G 1 ²	49451	15.4	0.309	0.210
25 G 1 ²	49454	17.7	0.428	0.302

Additional types upon request.



More information:
traxline.de

tsubaki-kabelschlepp.com

Technical support:
technik@kabelschlepp.de

TRAXLINE® CONTROL 1000 C TPE 300/500 V

Shielded continuous bending hi-flex TPE control cables

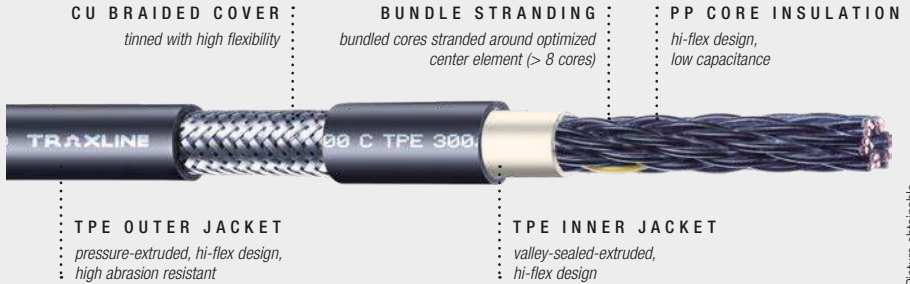
Definition
from page 164

Picture obtainable.

Technical Information
from page 178Up to **10 Million**
Motion cyclesUp to **1000 m**
Travel lengthTechnical support:
Fon: +49 (0)2762 4003-0**General information**

- Communication between transmitter and receiver
- Logical state of 0 and 1 control
- Good EMC-protection by overall-shield
- Signal for turning on and off/start and stop
- Outer jacket pressure extruded and high abrasion resistant
- Inner jacket valley-sealed extruded

Norms and standards

- Oil-resistant
- UV-resistant
- Ozone-resistant
- Silicone-free
- CFC-free
- REACH/RoHS II
- Halogen-free

Design

Conductor:	Class 6
Core insulation:	PP/9Y
Core identification:	Black, coded with white numbers, 1 x ye/gn
Core stranding:	Bundle stranded (> 8 cores) Layer stranded (≤ 8 cores)
Inner jacket:	TPE
Shield:	Shielded
Jacket color:	Black
Outer jacket:	TPE

Technical data

Temperature range while moved:	-35 up to +90 °C
Minimum bend radius while moved:	$KR_{min} \geq 5 \times \emptyset$
V_{max} supported:	20 m/s
V_{max} gliding:	5 m/s
a_{max} supported:	50 m/s ²
a_{max} gliding:	50 m/s ²
Insulation resistance:	> 30 MΩ x km
Nominal voltage control core(s):	according to VDE 0.30/0.50 kV

Varying parameters possible

TRAXLINE® CONTROL 1000 C TPE 300/500 V – Shielded

Core number x Cross-section [mm ²]	Part no.	max. Ø [mm]	Cable weight [kg/m]	Copper weight [kg/m]
(12 G 0.5 ²)	49709	12.5	0.209	0.109
(18 G 0.5 ²)	49712	14.5	0.274	0.167
(25 G 0.5 ²)	49715	16.6	0.364	0.212
(12 G 0.75 ²)	49729	13.5	0.242	0.147
(18 G 0.75 ²)	49732	15.9	0.328	0.222
(25 G 0.75 ²)	49735	19.0	0.482	0.293
(12 G 1 ²)	49749	14.3	0.281	0.174
(18 G 1 ²)	49752	17.8	0.496	0.240
(25 G 1 ²)	49755	20.8	0.585	0.332
(36 G 1 ²)	49757	25.4	0.851	0.485
(49 G 1 ²)	49759	30.0	1.136	0.660

Additional types upon request.



More information:
traxline.de

tsubaki-kabelschlepp.com

Technical support:
technik@kabelschlepp.de

TRAXLINE®

Power cables

Multi core/single core



Trademarks are legally protected for the TSUBAKI
KABELSCHLEPP GmbH as a national or international
registration in the following countries:
tsubaki-kabelschlepp.com/trademarks

Subject to change.

Power cables multi-core/single core | Overview

POWER 400 1 kV

Page 38



Outer jacket: PVC
Shield: Unshielded
Flexibility: hi-flex
Demands: demanding/
high demanding

Up to motion cycles: 4 Million
Travel length up to: 100 m

POWER 400 C 1 kV

Page 40



Outer jacket: PVC
Shield: Shielded
Flexibility: hi-flex
Demands: demanding/
high demanding

Up to motion cycles: 4 Million
Travel length up to: 100 m

POWER 700 1 kV

Page 42



Outer jacket: PUR
Shield: Unshielded
Flexibility: hi-flex
Demands: high demanding
Up to motion cycles: 7 Million
Travel length up to: 500 m

POWER 700 C 1 kV

Page 44



Outer jacket: PUR
Shield: Shielded
Flexibility: hi-flex
Demands: high demanding
Up to motion cycles: 7 Million
Travel length up to: 500 m

POWER 1000 TPE 1 kV

Page 46



Outer jacket: TPE
Shield: Unshielded
Flexibility: hi-flex
Demands: very high
demanding
Up to motion cycles: 10 Million
Travel length up to: 1000 m

POWER 1000 C TPE 1 kV

Page 48



Outer jacket: TPE
Shield: Shielded
Flexibility: hi-flex
Demands: very high
demanding
Up to motion cycles: 10 Million
Travel length up to: 1000 m

POWER ONE 700 1 kV

Page 50



Outer jacket: PUR
Shield: Unshielded
Flexibility: hi-flex
Demands: high demanding
Up to motion cycles: 7 Million
Travel length up to: 500 m

POWER ONE 700 C 1 kV

Page 52



Outer jacket: PUR
Shield: Shielded
Flexibility: hi-flex
Demands: high demanding
Up to motion cycles: 7 Million
Travel length up to: 500 m

POWER ONE 700 PE

Page 54



Outer jacket: PUR
Shield: Unshielded
Flexibility: hi-flex
Demands: high demanding
Up to motion cycles: 7 Million
Travel length up to: 500 m

POWER ONE 1000 TPE 1 kV

Page 56



Outer jacket: TPE
Shield: Unshielded
Flexibility: hi-flex
Demands: very high
demanding
Up to motion cycles: 10 Million
Travel length up to: 1000 m

POWER ONE 1000 C TPE 1 kV

Page 58



Outer jacket: TPE
Shield: Shielded
Flexibility: hi-flex
Demands: very high
demanding
Up to motion cycles: 10 Million
Travel length up to: 1000 m

More information:
traxline.de

tsubaki-kabelschlepp.com

Technical support:
technik@kabelschlepp.de

TRAXLINE® POWER 400 1 KV

Unshielded continuous bending hi-flex PVC power cables

Definition
from page 164**BUNDLE STRANDING***bundled cores stranded around optimized center element (> 8 cores)***PVC OUTER JACKET***pressure-extruded, hi-flex design,
high abrasion resistant***PP CORE INSULATION***hi-flex design,
low capacitance*

Picture obtainable.

Technical Information
from page 178Up to **4 Million**
Motion cyclesUp to **100 m**
Travel lengthTechnical support:
Fon: +49 (0)2762 4003-0

General information

- Power supply for electrical applications and drives
- Transmission of large electrical currents
- Outer jacket valley-sealed extruded and high abrasion resistant

Norms and standards

- Oil-resistant
- UV-resistant
- Ozone-resistant
- Silicone-free
- CFC-free
- REACH/RoHS II
- Flame-retardant

Design

Conductor:	Class 6
Core insulation:	PP/9Y
Core identification:	Black, coded with white numbers, 1 x ye/gn
Core stranding:	Bundle stranded (> 8 cores) Layer stranded (≤ 8 cores)
Shield:	Unshielded
Jacket color:	Black
Outer jacket:	PVC

Technical data

Temperature range while moved:	-5 up to +80 °C (-5 up to +80 °C UL)
Minimum bend radius while moved:	$KR_{min} \geq 7.5 \times \varnothing$
V_{max} supported:	5 m/s
V_{max} gliding:	3 m/s
a_{max} supported:	20 m/s ²
a_{max} gliding:	20 m/s ²
Insulation resistance:	> 30 MΩ x km
Nominal voltage power core(s):	according to VDE 0.60/1.0 kV according to UL 1.00 kV

Varying parameters possible

Power cables multi-core | Type selection

TRAXLINE® POWER 400 1 KV – Unshielded

Core number x Cross-section [mm ²]	Part no.	max. Ø [mm]	Cable weight [kg/m]	Copper weight [kg/m]
3 G 1.5 ²	45201	7.8	0.088	0.045
4 G 1.5 ²	45202	8.4	0.109	0.060
5 G 1.5 ²	45203	9.2	0.129	0.072
7 G 1.5 ²	45205	10.8	0.173	0.105
12 G 1.5 ²	45209	14.7	0.308	0.180
18 G 1.5 ²	45211	18.0	0.453	0.270
20 G 1.5 ²	45213	18.2	0.525	0.303
25 G 1.5 ²	45214	21.1	0.627	0.405
3 G 2.5 ²	45221	9.0	0.128	0.075
4 G 2.5 ²	45222	9.8	0.158	0.100
5 G 2.5 ²	45223	10.8	0.190	0.125
7 G 2.5 ²	45225	12.7	0.259	0.168
12 G 2.5 ²	45229	17.9	0.483	0.300
18 G 2.5 ²	45231	22.2	0.706	0.450
25 G 2.5 ²	45234	24.8	0.949	0.625
4 G 4 ²	45242	11.6	0.233	0.160
5 G 4 ²	45243	12.9	0.287	0.200
7 G 4 ²	45245	15.3	0.399	0.280
4 G 6 ²	45252	13.6	0.336	0.240
5 G 6 ²	45253	15.1	0.410	0.288
7 G 6 ²	45254	18.5	0.600	0.420
4 G 10 ²	45262	17.0	0.542	0.400
5 G 10 ²	45263	18.9	0.669	0.480
4 G 16 ²	45272	21.0	0.861	0.640
5 G 16 ²	45273	23.7	1.091	0.768
4 G 25 ²	45282	25.7	1.308	1.000
4 G 35 ²	45292	30.1	1.818	1.400
4 G 50 ²	45302	34.6	2.545	1.910
4 G 70 ²	45312	40.7	3.564	2.700

Additional types upon request.



Cable+Connector
ready to connection

More information:
traxline.de

tsubaki-kabelschlepp.com

Technical support:
technik@kabelschlepp.de

TRAXLINE® POWER 400 C 1 KV

Shielded continuous bending hi-flex PVC power cables

Definition
from page 164

Picture obtainable.

Technical Information
from page 178Up to **4 Million**
Motion cyclesUp to **100 m**
Travel length**General information**

- Power supply for electrical applications and drives
- Transmission of large electrical currents
- Good EMC-protection by overall-shield
- Outer jacket pressure extruded and high abrasion resistant
- Inner jacket valley-sealed extruded

Norms and standards

- Oil-resistant
- UV-resistant
- Ozone-resistant
- Silicone-free
- CFC-free
- REACH/RoHS II
- Flame-retardant

Technical support:
Fon: +49 (0)2762 4003-0**Design**

Conductor:	Class 36
Core insulation:	PP/9Y
Core identification:	Black, coded with white numbers, 1 x ye/gn
Core stranding:	Bundle stranded (> 8 cores) Layer stranded (≤ 8 cores)
Inner jacket:	PVC
Shield:	Shielded
Jacket color:	Black
Outer jacket:	PVC

Technical data

Temperature range while moved:	-5 up to +80 °C (-5 up to +80 °C UL)
Minimum bend radius while moved:	$KR_{min} \geq 7.5 \times \varnothing$
V_{max} supported:	5 m/s
V_{max} gliding:	5 m/s
a_{max} supported:	20 m/s ²
a_{max} gliding:	20 m/s ²
Insulation resistance:	> 30 MΩ x km
Nominal voltage power core(s):	according to VDE 0.60/1.0 kV according to UL 1.00 kV

Varying parameters possible

TRAXLINE® POWER 400 C 1 KV – Shielded

Core number x Cross-section [mm ²]	Part no.	max. Ø [mm]	Cable weight [kg/m]	Copper weight [kg/m]
(4 G 1.5 ²)	47202	10.4	0.165	0.104
(4 G 2.5 ²)	47222	11.8	0.222	0.148
(5 G 2.5 ²)	47223	12.8	0.263	0.171
(7 G 2.5 ²)	47225	15.1	0.365	0.235
(4 G 4 ²)	47242	13.7	0.319	0.209
(5 G 4 ²)	47243	15.1	0.412	0.273
(7 G 4 ²)	47245	18.1	0.537	0.360
(4 G 6 ²)	47252	16.1	0.450	0.307
(5 G 6 ²)	47253	17.9	0.558	0.439
(4 G 10 ²)	47262	20.0	0.701	0.520
(5 G 10 ²)	47263	22.0	0.856	0.592
(4 G 16 ²)	47272	24.5	1.088	0.746
(5 G 16 ²)	47273	27.1	1.379	1.050
(4 G 25 ²)	47282	29.3	1.578	1.163
(4 G 35 ²)	47292	33.9	2.178	1.667

Additional types upon request.



Cable+Connector
ready to connection

More information:
traxline.de

tsubaki-kabelschlepp.com

Technical support:
technik@kabelschlepp.de

TRAXLINE® POWER 700 1 KV

Unshielded continuous bending hi-flex PUR power cables

Definition
from page 164**BUNDLE STRANDING***bundled cores stranded around optimized center element (> 8 cores)***PUR OUTER JACKET***pressure-extruded, hi-flex design,
high abrasion resistant***PP CORE INSULATION***hi-flex design,
low capacitance*

Picture obtainable.

Technical Information
from page 178Up to **7 Million**
Motion cyclesUp to **500 m**
Travel length

General information

- Power supply for electrical applications and drives
- Transmission of large electrical currents
- Outer jacket valley-sealed extruded and high abrasion resistant

Norms and standards

- Oil-resistant
- UV-resistant
- Ozone-resistant
- Silicone-free
- CFC-free
- REACH/RoHS II
- Flame-retardant
- NEK 606
- Halogen-free

Technical support:
Fon: +49 (0)2762 4003-0

Design

Conductor:	Class 6
Core insulation:	PP/9Y
Core identification:	Black, coded with white numbers, 1 x ye/gn
Core stranding:	Bundle stranded (> 8 cores) Layer stranded (≤ 8 cores)
Shield:	Unshielded
Jacket color:	Black
Outer jacket:	PUR

Technical data

Temperature range while moved:	-35 up to +90 °C (-35 up to +80 °C UL)
Minimum bend radius while moved:	$KR_{min} \geq 7.5 \times \varnothing$
V_{max} supported:	20 m/s
V_{max} gliding:	5 m/s
a_{max} supported:	50 m/s ²
a_{max} gliding:	50 m/s ²
Insulation resistance:	> 30 MΩ x km
Nominal voltage power core(s):	according to VDE 0.60/1.0 kV according to UL 1.00 kV

Varying parameters possible

Power cables multi-core | Type selection

TRAXLINE® POWER 700 1 KV – Unshielded

Core number x Cross-section [mm ²]	Part no.	max. Ø [mm]	Cable weight [kg/m]	Copper weight [kg/m]
3 G 1.5 ²	45501	7.8	0.088	0.045
4 G 1.5 ²	45502	8.4	0.109	0.058
5 G 1.5 ²	45503	9.2	0.129	0.072
7 G 1.5 ²	45505	10.8	0.173	0.105
12 G 1.5 ²	45509	14.7	0.307	0.195
18 G 1.5 ²	45511	18.0	0.452	0.270
25 G 1.5 ²	45514	21.1	0.626	0.405
36 G 1.5 ²	45516	26.2	0.904	0.540
3 G 2.5 ²	45521	9.0	0.127	0.075
4 G 2.5 ²	45522	9.8	0.158	0.108
5 G 2.5 ²	45523	10.8	0.190	0.125
7 G 2.5 ²	45525	12.7	0.259	0.175
12 G 2.5 ²	45529	17.9	0.482	0.300
18 G 2.5 ²	45531	22.2	0.704	0.450
25 G 2.5 ²	45534	24.8	0.947	0.625
36 G 2.5 ²	45536	30.7	1.337	0.900
3 G 4 ²	45541	10.6	0.187	0.120
4 G 4 ²	45542	11.6	0.233	0.154
7 G 4 ²	45543	15.3	0.399	0.269
5 G 4 ²	45544	12.9	0.284	0.240
12 G 4 ²	45546	22.1	0.748	0.461
30 G 4 ²	45549	33.6	1.774	1.152
3 G 6 ²	45551	12.3	0.265	0.173
4 G 6 ²	45552	13.6	0.336	0.240
5 G 6 ²	45553	15.1	0.419	0.288
7 G 6 ²	45555	18.5	0.599	0.403
3 G 10 ²	45561	15.2	0.418	0.288
4 G 10 ²	45562	17.0	0.541	0.384
5 G 10 ²	45563	18.9	0.668	0.500
3 G 16 ²	45564	18.8	0.672	0.461
4 G 16 ²	45565	21.0	0.869	0.640
5 G 16 ²	45566	23.7	1.089	0.800
3 G 25 ²	45567	23.0	1.019	0.750
4 G 25 ²	45568	25.7	1.306	1.000
5 G 25 ²	45569	28.9	1.626	1.200
3 G 35 ²	45570	26.7	1.395	1.008
4 G 35 ²	45571	30.1	1.815	1.344
5 G 35 ²	45560	33.7	2.249	1.750
3 G 50 ²	45559	30.7	1.954	1.440
4 G 50 ²	45572	34.6	2.541	1.920
4 G 70 ²	45573	40.7	3.559	2.700
4 G 95 ²	45574	45.3	4.451	3.800

Additional types upon request.



More information:
traxline.de

tsubaki-kabelschlepp.com

Technical support:
technik@kabelschlepp.de

TRAXLINE® POWER 700 C 1 KV

Shielded continuous bending hi-flex PUR power cables

Definition
from page 164Technical Information
from page 178Up to **7 Million**
Motion cyclesUp to **500 m**
Travel length**General information**

- Power supply for electrical applications and drives
- Transmission of large electrical currents
- Good EMC-protection by overall-shield
- Outer jacket pressure extruded and high abrasion resistant
- Inner jacket valley-sealed extruded

Norms and standards

- Oil-resistant
- UV-resistant
- Ozone-resistant
- Silicone-free
- CFC-free
- REACH/RoHS II
- Flame-retardant
- NEK 606
- Halogen-free

Technical support:
Fon: +49 (0)2762 4003-0**Design**

Conductor:	Class 6
Core insulation:	PP/9Y
Core identification:	Black, coded with white numbers, 1 x ye/gn
Core stranding:	Bundle stranded (> 8 cores) Layer stranded (≤ 8 cores)
Inner jacket:	TPE
Shield:	Shielded
Jacket color:	Black
Outer jacket:	PUR

Technical data

Temperature range while moved:	-35 up to +90 °C (-35 up to +80 °C UL)
Minimum bend radius while moved:	$KR_{min} \geq 7.5 \times \varnothing$
V_{max} supported:	20 m/s
V_{max} gliding:	5 m/s
a_{max} supported:	50 m/s ²
a_{max} gliding:	50 m/s ²
Insulation resistance:	> 30 MΩ x km
Nominal voltage power core(s):	according to VDE 0.60/1.0 kV according to UL 1.00 kV

Varying parameters possible

Power cables multi-core | Type selection

TRAXLINE® POWER 700 C 1 KV – Shielded

Core number x Cross-section [mm ²]	Part no.	max. Ø [mm]	Cable weight [kg/m]	Copper weight [kg/m]
(2 x 1.5 ²)	45760	9.2	0.112	0.064
(3 G 1.5 ²)	45761	9.6	0.130	0.075
(4 G 1.5 ²)	45762	10.5	0.158	0.089
(5 G 1.5 ²)	45763	11.3	0.181	0.108
(7 G 1.5 ²)	45765	13.0	0.239	0.148
(12 G 1.5 ²)	45769	17.4	0.410	0.264
(18 G 1.5 ²)	45772	21.7	0.585	0.362
(25 G 1.5 ²)	45775	24.6	0.825	0.564
(36 G 1.5 ²)	45777	30.0	1.171	0.698
(49 G 1.5 ²)	45778	36.4	2.054	0.950
(3 G 2.5 ²)	45780	11.0	0.176	0.110
(4 G 2.5 ²)	45781	11.9	0.214	0.142
(5 G 2.5 ²)	45783	12.9	0.253	0.170
(7 G 2.5 ²)	45785	15.2	0.353	0.268
(12 G 2.5 ²)	45787	21.1	0.617	0.421
(18 G 2.5 ²)	45789	25.5	0.895	0.607
(20 G 2.5 ²)	45790	25.7	0.943	0.621
(25 G 2.5 ²)	45791	28.8	1.166	0.765
(4 G 4 ²)	45801	13.8	0.306	0.211
(4 G 6 ²)	45802	16.2	0.432	0.298
(4 G 10 ²)	45803	20.1	0.671	0.526
(4 G 16 ²)	45804	24.7	1.050	0.781
(5 G 16 ²)	45812	27.7	1.289	0.904
(4 G 25 ²)	45805	29.4	1.522	1.145
(4 G 35 ²)	45806	34.0	2.113	1.667
(4 G 50 ²)	45807	39.2	2.902	2.306
(4 G 70 ²)	45808	45.8	4.016	3.045
(4 G 95 ²)	45809	50.6	5.094	4.060
(4 G 120 ²)	45810	56.2	6.230	5.128
(4 G 150 ²)	45811	66.0	7.765	6.525

Additional types upon request.



TRAXLINE® POWER 1000 TPE 1 KV

Unshielded continuous bending hi-flex TPE power cables

Definition
from page 164**BUNDLE STRANDING***bundled cores stranded around optimized center element (> 8 cores)***TPE OUTER JACKET***pressure-extruded, hi-flex design,
high abrasion resistant***PP CORE INSULATION***hi-flex design,
low capacitance*

Picture obtainable.

Technical Information
from page 178Up to **10 Million**
Motion cyclesUp to **1000 m**
Travel lengthTechnical support:
Fon: +49 (0)2762 4003-0

General information

- Power supply for electrical applications and drives
- Transmission of large electrical currents
- Outer jacket valley-sealed extruded and high abrasion resistant

Norms and standards

- Oil-resistant
- UV-resistant
- Ozone-resistant
- Silicone-free
- CFC-free
- REACH/RoHS II
- Halogen-free

Design

Conductor:	Class 6
Core insulation:	PP/TPE
Core identification:	Black, coded with white numbers, 1 x ye/gn
Core stranding:	Bundle stranded (> 8 cores) Layer stranded (≤ 8 cores)
Shield:	Shielded
Jacket color:	Black
Outer jacket:	TPE

Technical data

Temperature range while moved:	-35 up to +90 °C
Minimum bend radius while moved:	$KR_{min} \geq 5 \times \varnothing$
V_{max} supported:	20 m/s
V_{max} gliding:	5 m/s
a_{max} supported:	50 m/s ²
a_{max} gliding:	50 m/s ²
Insulation resistance:	> 30 MΩ x km
Nominal voltage power core(s):	according to VDE 0.60/1.0 kV

Varying parameters possible

Power cables multi-core | Type selection

TRAXLINE® POWER 1000 TPE 1 KV – Unshielded

Core number x Cross-section [mm ²]	Part no.	max. Ø [mm]	Cable weight [kg/m]	Copper weight [kg/m]
25 G 2.5 ²	49534	24.8	0.904	0.625
4 G 4 ²	49542	11.5	0.227	0.154
7 G 4 ²	49543	15.3	0.395	0.268
5 G 4 ²	49544	12.9	0.282	0.240
4 G 6 ²	49552	13.5	0.331	0.240
5 G 6 ²	49553	15.1	0.411	0.288
7 G 6 ²	49555	18.2	0.578	0.403
4 G 10 ²	49562	16.9	0.546	0.384
5 G 10 ²	49563	18.9	0.658	0.500
4 G 16 ²	49565	21.0	0.834	0.640
5 G 16 ²	49566	23.7	0.923	0.800
4 G 25 ²	49568	25.8	1.329	1.000
5 G 25 ²	49569	28.8	1.599	1.200
4 G 35 ²	49571	29.8	1.763	1.344
5 G 35 ²	49560	33.4	2.187	1.750
4 G 50 ²	49572	34.4	2.556	1.920
4 G 70 ²	49573	40.6	3.594	2.700
4 G 95 ²	49574	45.1	4.481	3.800

Additional types upon request.



More information:
traxline.de

tsubaki-kabelschlepp.com

Technical support:
technik@kabelschlepp.de

TRAXLINE® POWER 1000 C TPE 1 KV

Shielded continuous bending hi-flex TPE power cables

Definition
from page 164

Picture obtainable.

Technical Information
from page 178Up to **10 Million**
Motion cyclesUp to **1000 m**
Travel lengthTechnical support:
Fon: +49 (0)2762 4003-0**General information**

- Power supply for electrical applications and drives
- Transmission of large electrical currents
- Good EMC-protection by overall-shield
- Outer jacket pressure extruded and high abrasion resistant
- Inner jacket valley-sealed extruded

Norms and standards

- Oil-resistant
- UV-resistant
- Ozone-resistant
- Silicone-free
- CFC-free
- REACH/RoHS II
- Halogen-free

Design

Conductor:	Class 6
Core insulation:	PP/TPE
Core identification:	Black, coded with white numbers, 1 x ye/gn
Core stranding:	Bundle stranded (> 8 cores) Layer stranded (≤ 8 cores)
Inner jacket:	TPE
Shield:	Shielded
Jacket color:	Black
Outer jacket:	TPE

Technical data

Temperature range while moved:	-35 up to +90 °C
Minimum bend radius while moved:	$KR_{min} \geq 5 \times \emptyset$
V_{max} supported:	20 m/s
V_{max} gliding:	5 m/s
a_{max} supported:	50 m/s ²
a_{max} gliding:	50 m/s ²
Insulation resistance:	> 30 MΩ x km
Nominal voltage power core(s):	according to VDE 0.60/1.0 kV

Varying parameters possible

TRAXLINE® POWER 1000 C TPE 1 KV – Shielded

Core number x Cross-section [mm ²]	Part no.	max. Ø [mm]	Cable weight [kg/m]	Copper weight [kg/m]
(4 G 4 ²)	49801	13.7	0.313	0.211
(4 G 6 ²)	49802	16.1	0.432	0.298
(4 G 10 ²)	49803	19.9	0.680	0.526
(4 G 16 ²)	49804	24.7	1.079	0.781
(5 G 16 ²)	49812	27.7	1.368	0.904
(4 G 25 ²)	49805	29.2	1.516	1.145
(4 G 35 ²)	49806	34.0	2.060	1.667
(4 G 50 ²)	49807	38.9	2.833	2.306
(4 G 70 ²)	49808	45.6	3.974	3.045
(4 G 95 ²)	49809	50.4	5.145	4.060
(4 G 120 ²)	49810	55.9	6.424	5.128
(4 G 150 ²)	49811	62.5	7.783	6.525

Additional types upon request.



More information:
traxline.de

tsubaki-kabelschlepp.com

Technical support:
technik@kabelschlepp.de

TRAXLINE® POWER ONE 700 1 KV

Unshielded continuous bending hi-flex PUR single-core cables

Definition
from page 164

PP CORE INSULATION :
*hi-flex design,
low capacitance*

WIRE BUNDLES :
*short pitch length,
hi-flex design*



PUR OUTER JACKET
*pressure-extruded, hi-flex design,
high abrasion resistant*

Picture obtainable.

Technical Information
from page 178

Up to **7 Million**
Motion cycles



Up to **500 m**
Travel length



Technical support:

Fon: +49 (0)2762 4003-0

Cable Carrier Configurator

General information

- Power supply for electrical applications and drives
- Transmission of large electrical currents
- For small bending radii and long travel distance
- Outer jacket pressure extruded and high abrasion resistant

Norms and standards

- Oil-resistant
- UV-resistant
- Ozone-resistant
- Silicone-free
- CFC-free
- REACH/RoHS II
- Flame-retardant
- NEK 606
- Halogen-free

Design

Conductor: Class 6

Core insulation: PP/9Y

Core identification: Schwarz

Core stranding: Single core

Shield: Shielded

Jacket color: Black

Outer jacket: PUR

Technical data

Temperature range while moved: -35 up to +90 °C
(-35 up to +80 °C UL)

Minimum bend radius while moved: $KR_{min} \geq 7.5 \times \varnothing$

V_{max} supported: 20 m/s

V_{max} gliding: 5 m/s

a_{max} supported: 50 m/s²

a_{max} gliding: 50 m/s²

Insulation resistance: > 0.10 MΩ x km

Nominal voltage power core(s): according to VDE 0.60/1.0 kV
according to UL 1.00 kV

Varying parameters possible

Power cables single core | Type selection

TRAXLINE® POWER ONE 700 1 KV – Unshielded

Core number x Cross-section [mm ²]	Part no.	max. Ø [mm]	Cable weight [kg/m]	Copper weight [kg/m]
1 x 0.25 ²	45575	4.1	0.017	0.002
1 x 0.34 ²	45576	4.2	0.019	0.003
1 x 0.5 ²	45577	4.3	0.021	0.005
1 x 0.75 ²	45578	4.7	0.026	0.007
1 x 1 ²	45579	4.9	0.029	0.010
1 x 1.5 ²	45580	5.6	0.039	0.014
1 x 2.5 ²	45581	6.2	0.053	0.025
1 x 4 ²	45582	6.8	0.072	0.040
1 x 6 ²	45583	7.4	0.094	0.060
1 x 10 ²	45584	8.6	0.142	0.100
1 x 16 ²	45585	9.7	0.204	0.154
1 x 25 ²	45586	11.3	0.298	0.240
1 x 35 ²	45587	12.7	0.397	0.350
1 x 50 ²	45588	15.0	0.571	0.500
1 x 70 ²	45589	17.0	0.785	0.700
1 x 95 ²	45590	19.5	1.029	0.950
1 x 120 ²	45591	21.4	1.285	1.200
1 x 150 ²	45592	24.2	1.572	1.500
1 x 185 ²	45593	26.6	1.919	1.850
1 x 240 ²	45594	30.2	2.503	2.304
1 x 300 ²	45595	34.4	3.119	2.880
1 x 400 ²	45596	40.2	4.042	3.800
1 x 500 ²	45597	42.8	5.142	5.000
1 x 700 ²	45598	49.9	7.405	6.680

Additional types upon request.



More information:
traxline.de

tsubaki-kabelschlepp.com

Technical support:
technik@kabelschlepp.de

TRAXLINE® POWER ONE 700 C 1 KV

Shielded continuous bending hi-flex PUR single-core cables

Definition
from page 164**CU BRAIDED COVER**
*tinned with high flexibility***WIRE BUNDLES**
*short pitch length,
hi-flex design***PUR OUTER JACKET**
*pressure-extruded, hi-flex design,
high abrasion resistant***PP CORE INSULATION**
*hi-flex design,
low capacitance*

Picture obtainable.

Technical Information
from page 178Up to **7 Million**
Motion cyclesUp to **500 m**
Travel lengthTechnical support:
Fon: +49 (0)2762 4003-0**General information**

- Power supply for electrical applications and drives
- Transmission of large electrical currents
- Good EMC-protection by overall-shield
- For small bending radii and long travel distance
- Outer jacket pressure extruded and high abrasion resistant

Norms and standards

- Oil-resistant
- UV-resistant
- Ozone-resistant
- Silicone-free
- CFC-free
- REACH/RoHS II
- Flame-retardant
- NEK 606
- Halogen-free

Design

Conductor:	Class 6
Core insulation:	PP/9Y
Core identification:	Black
Core stranding:	Single core
Shield:	Shielded
Jacket color:	Black
Outer jacket:	PUR

Technical data

Temperature range while moved:	-35 up to +90 °C (-35 up to +80 °C UL)
Minimum bend radius while moved:	$KR_{min} \geq 7.5 \times \emptyset$
V_{max} supported:	20 m/s
V_{max} gliding:	5 m/s
a_{max} supported:	50 m/s ²
a_{max} gliding:	50 m/s ²
Insulation resistance:	> 0.1 MΩ x km
Nominal voltage power core(s):	according to VDE 0.60/1.0 kV according to UL 1.00 kV

Varying parameters possible

Power cables single core | Type selection

TRAXLINE® POWER ONE 700 C 1 KV – Shielded

Core number x Cross-section [mm ²]	Part no.	max. Ø [mm]	Cable weight [kg/m]	Copper weight [kg/m]
(1 x 1.5 ²)	45814	6.1	0.054	0.029
(1 x 2.5 ²)	45815	6.8	0.070	0.041
(1 x 4 ²)	45816	7.4	0.091	0.059
(1 x 6 ²)	45817	8.0	0.115	0.071
(1 x 10 ²)	45818	9.2	0.167	0.122
(1 x 16 ²)	45819	10.4	0.234	0.190
(1 x 25 ²)	45820	11.9	0.332	0.289
(1 x 35 ²)	45821	13.3	0.446	0.393
(1 x 50 ²)	45822	15.6	0.630	0.560
(1 x 70 ²)	45823	17.8	0.859	0.750
(1 x 95 ²)	45824	20.3	1.112	1.029
(1 x 120 ²)	45825	22.2	1.378	1.272
(1 x 150 ²)	45826	25.2	1.703	1.578
(1 x 185 ²)	45827	27.4	2.043	1.911
(1 x 240 ²)	45828	31.1	2.638	2.451
(1 x 300 ²)	45829	35.4	3.341	2.997

Additional types upon request.



Cable+Connector
ready to connection

More information:
traxline.de

tsubaki-kabelschlepp.com

Technical support:
technik@kabelschlepp.de

TRAXLINE® POWER ONE 700 PE

Unshielded, continuous bending highly-flexible PUR single-core cables with PE core identification identification

Definition
from page 164

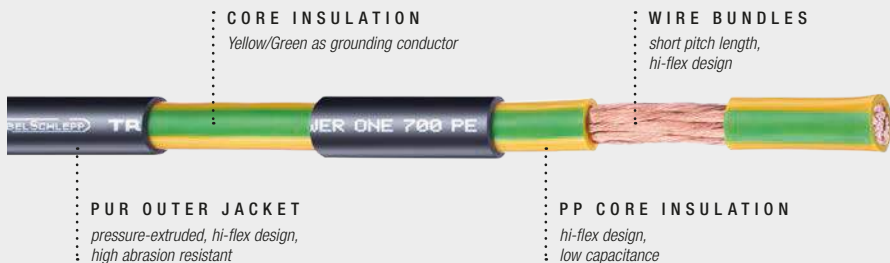

Picture obtainable.

Technical Information
from page 178



Up to **7 Million**
Motion cycles



Up to **500 m**
Travel length



Technical support:
Fon: +49 (0)2762 4003-0

General information

- Transmission of large electrical currents
- PE = Core insulation yellow/green
- For small bending radii and long travel distance
- Outer jacket pressure extruded and high abrasion resistant

Norms and standards

- Oil-resistant
- UV-resistant
- Ozone-resistant
- Silicone-free
- CFC-free
- REACH/RoHS II
- Flame-retardant
- NEK 606
- Halogen-free

Design

Conductor:	Class 6
Core insulation:	PP/9Y
Core identification:	Yellow/Green
Core stranding:	Single core
Shield:	Unshielded
Jacket color:	Black
Outer jacket:	PUR

Technical data

Temperature range while moved:	-35 up to +90 °C (-35 up to +80 °C UL)
Minimum bend radius while moved:	$KR_{min} \geq 7.5 \times \emptyset$
V_{max} supported:	20 m/s
V_{max} gliding:	5 m/s
a_{max} supported:	50 m/s ²
a_{max} gliding:	50 m/s ²
Insulation resistance:	> 0.1 MΩ x km
Nominal voltage power core(s):	according to VDE 0.60/1.0 kV according to UL 1.00 kV

Varying parameters possible

Power cables single core | Type selection

TRAXLINE® POWER ONE 700 PE – Unshielded

Core number x Cross-section [mm ²]	Part no.	max. Ø [mm]	Cable weight [kg/m]	Copper weight [kg/m]
1 G 1.5 ²	47580	5.6	0.039	0.014
1 G 2.5 ²	47581	6.2	0.053	0.025
1 G 4 ²	47582	6.8	0.071	0.040
1 G 6 ²	47583	7.4	0.094	0.060
1 G 10 ²	47584	8.6	0.142	0.100
1 G 16 ²	47585	9.7	0.203	0.154
1 G 25 ²	47586	11.3	0.298	0.213
1 G 35 ²	47587	12.7	0.397	0.302
1 G 50 ²	47588	15.0	0.571	0.434
1 G 70 ²	47589	17.0	0.785	0.700
1 G 95 ²	47590	19.5	1.029	0.950
1 G 120 ²	47591	21.4	1.285	1.200
1 G 150 ²	47592	24.2	1.572	1.500
1 G 185 ²	47593	26.6	1.919	1.850
1 G 240 ²	47594	30.2	2.503	2.304

Additional types upon request.



Cable+Connector
ready to connection

More information:
traxline.de

tsubaki-kabelschlepp.com

Technical support:
technik@kabelschlepp.de

TRAXLINE® POWER ONE 1000 TPE 1 KV

Unshielded continuous bending hi-flex TPE single-core cables

Definition
from page 164**PP CORE INSULATION***hi-flex design,
low capacitance***TPE OUTER JACKET***pressure-extruded, hi-flex design,
high abrasion resistant***WIRE BUNDLES***short pitch length,
hi-flex design*

Picture obtainable.

Technical Information
from page 178Up to **10 Million**
Motion cyclesUp to **1000 m**
Travel lengthTechnical support:
Fon: +49 (0)2762 4003-0**General information**

- Power supply for electrical applications and drives
- Transmission of large electrical currents
- For small bending radii and long travel distance
- Outer jacket pressure extruded and high abrasion resistant

Norms and standards

- Oil-resistant
- UV-resistant
- Ozone-resistant
- Silicone-free
- CFC-free
- REACH/RoHS II
- Halogen-free

Design

Conductor:	Class 6
Core insulation:	PP/TPE
Core identification:	Black
Core stranding:	Single core
Shield:	Unshielded
Jacket color:	Black
Outer jacket:	TPE

Technical data

Temperature range while moved:	-35 up to +90 °C
Minimum bend radius while moved:	$KR_{min} \geq 5 \times \varnothing$
v_{max} supported:	20 m/s
v_{max} gliding:	5 m/s
a_{max} supported:	50 m/s ²
a_{max} gliding:	50 m/s ²
Insulation resistance:	> 30 MΩ x km
Nominal voltage power core(s):	according to VDE 0.60/1.0 KV

Varying parameters possible

Power cables single core | Type selection

TRAXLINE® POWER ONE 1000 TPE 1 KV – Unshielded

Core number x Cross-section [mm ²]	Part no.	max. Ø [mm]	Cable weight [kg/m]	Copper weight [kg/m]
1 x 2.5 ²	49581	6.2	0.054	0.025
1 x 4 ²	49582	6.8	0.074	0.040
1 x 6 ²	49583	7.4	0.096	0.060
1 x 10 ²	49584	8.6	0.145	0.100
1 x 16 ²	49585	9.7	0.207	0.154
1 x 25 ²	49586	11.3	0.303	0.240
1 x 35 ²	49587	12.7	0.404	0.350
1 x 50 ²	49588	15.0	0.580	0.434
1 x 70 ²	49589	17.0	0.796	0.700
1 x 95 ²	49590	19.5	1.042	0.950
1 x 120 ²	49591	21.4	1.268	1.200
1 x 150 ²	49592	24.2	1.595	1.500
1 x 185 ²	49593	26.6	1.949	1.850
1 x 240 ²	49594	30.2	2.537	2.304
1 x 300 ²	49595	34.4	3.160	2.880

Additional types upon request.



Cable+Connector
ready to connection

More information:
traxline.de

tsubaki-kabelschlepp.com

Technical support:
technik@kabelschlepp.de

TRAXLINE® POWER ONE 1000 C TPE 1 KV

Shielded continuous bending hi-flex TPE single-core cables

Definition
from page 164

CU BRAIDED COVER :
tinned with high flexibility

WIRE BUNDLES :
short pitch length,
hi-flex design



TPE OUTER JACKET
pressure-extruded, hi-flex design,
high abrasion resistant

PP CORE INSULATION
hi-flex design,
low capacitance

Picture obtainable.

Technical Information
from page 178

Up to **10 Million**
Motion cycles



Up to **1000 m**
Travel length

Technical support:
Fon: +49 (0)2762 4003-0

General information

- Power supply for electrical applications and drives
- Transmission of large electrical currents
- Good EMC-protection by overall-shield
- For small bending radii and long travel distance
- Outer jacket pressure extruded and high abrasion resistant

Norms and standards

- Oil-resistant
- UV-resistant
- Ozone-resistant
- Silicone-free
- CFC-free
- REACH/RoHS II
- Halogen-free

Design

Conductor: Class 6

Core insulation: PP/TPE

Core identification: Black

Core stranding: Single core

Shield: Shielded

Jacket color: Black

Outer jacket: TPE

Technical data

Temperature range while moved: -35 up to +90 °C

Minimum bend radius while moved: $KR_{min} \geq 5 \times \emptyset$

V_{max} supported: 20 m/s

V_{max} gliding: 5 m/s

a_{max} supported: 50 m/s²

a_{max} gliding: 50 m/s²

Insulation resistance: > 30 MΩ x km

Nominal voltage power core(s): according to VDE 0.60/1.0 kV

Varying parameters possible

Power cables single core | Type selection

TRAXLINE® POWER ONE 1000 C TPE 1 KV – Shielded

Core number x Cross-section [mm ²]	Part no.	max. Ø [mm]	Cable weight [kg/m]	Copper weight [kg/m]
(1 x 4 ²)	49876	7.4	0.093	0.059
(1 x 6 ²)	49877	8.0	0.119	0.071
(1 x 10 ²)	49878	9.2	0.169	0.122
(1 x 16 ²)	49879	10.4	0.236	0.190
(1 x 25 ²)	49880	11.9	0.333	0.289
(1 x 35 ²)	49881	13.3	0.453	0.393
(1 x 50 ²)	49882	15.6	0.643	0.560
(1 x 70 ²)	49883	17.8	0.871	0.873
(1 x 95 ²)	49884	20.3	1.099	1.029
(1 x 120 ²)	49885	22.2	1.373	1.272
(1 x 150 ²)	49826	25.0	1.716	1.578
(1 x 185 ²)	49887	27.4	2.081	1.911
(1 x 240 ²)	49888	31.1	2.685	2.451
(1 x 300 ²)	49889	35.4	3.393	2.997

Additional types upon request.



More information:
traxline.de

tsubaki-kabelschlepp.com

Technical support:
technik@kabelschlepp.de

TRAXLINE®

High voltage cables

Single core



Trademarks are legally protected for the TSUBAKI
KABELSCHLEPP GmbH as a national or international
registration in the following countries:
tsubaki-kabelschlepp.com/trademarks

Subject to change.

High voltage cables single core | Overview

POWER ONE HEAVY DUTY 6/10 kV Page 62



Outer jacket: PUR
Shield: Shielded
Flexibility: hi-flex
Demands: very high demanding

Up to motion cycles: 1 Million

Travel length up to: 1000 m

POWER ONE HEAVY DUTY 6.7/11 kV Page 64



Outer jacket: PUR
Shield: Shielded
Flexibility: hi-flex
Demands: very high demanding

Up to motion cycles: 1 Million

Travel length up to: 1000 m

POWER ONE HEAVY DUTY 7.2/12 kV Page 66



Outer jacket: PUR
Shield: Shielded
Flexibility: hi-flex
Demands: very high demanding

Up to motion cycles: 1 Million

Travel length up to: 1000 m

More information:
traxline.de

tsubaki-kabelschlepp.com

Technical support:
technik@kabelschlepp.de

TRAXLINE® POWER ONE HEAVY DUTY 6/10 KV

Shielded continuous bending hi-flex PUR high performance cables

Definition
from page 164

Technical Information
from page 178



Picture obtainable.



Up to 1 Million
Motion cycles



Up to 1000 m
Travel length



Technical support:
Fon: +49 (0)2762 4003-0

General information

- Power supply for big electrical applications and drives
- Good EMC-protection by overall-shield
- For small bending radii and very long travel distance
- Side pressure strength, tear propagation strength and cut resistant
- Outer jacket pressure extruded and high abrasion resistant

Norms and standards

- Oil-resistant
- UV-resistant
- Ozone-resistant
- Silicone-free
- CFC-free
- REACH/RoHS II
- Flame-retardant
- NEK 606
- Halogen-free

Design

Conductor: Class 6

Core insulation: EPR

Core identification: Black

Core stranding: Wire bundles

Inner jacket: TPE

Shield: Shielded

Jacket color: Red

Outer jacket: PUR

Technical data

Temperature range while moved: -35 up to +80 °C

Minimum bend radius while moved: $KR_{min} \geq 7.5 \times \varnothing$

V_{max} supported: 10 m/s

V_{max} gliding: 6 m/s

a_{max} supported: 50 m/s²

a_{max} gliding: 20 m/s²

Insulation resistance: > 20 MΩ x km

Nominal voltage power core(s): according to VDE 6/10 KV

Varying parameters possible

High voltage cables single core | Type selection

High
voltage
cables

TRAXLINE® POWER ONE HEAVY DUTY 6/10 KV – Shielded

Core number x Cross-section [mm ²]	Part no.	max. Ø [mm]	Cable weight [kg/m]	Copper weight [kg/m]
(1 x 10 ² /10 ²)	49817	21.5	0.571	0.219
(1 x 16 ² /16 ²)	49818	22.9	0.712	0.369
(1 x 25 ² /16 ²)	49819	24.6	0.826	0.458
(1 x 35 ² /16 ²)	49820	26.2	0.962	0.572
(1 x 50 ² /16 ²)	49821	28.1	1.218	0.722
(1 x 70 ² /16 ²)	49822	30.3	1.414	0.921
(1 x 95 ² /16 ²)	49823	32.6	1.723	1.165
(1 x 120 ² /25 ²)	49824	35.5	1.996	1.550
(1 x 150 ² /25 ²)	49825	37.6	2.407	1.847
(1 x 185 ² /25 ²)	49816	40.2	2.984	2.542
(1 x 240 ² /25 ²)	49827	43.4	3.662	3.149
(1 x 300 ² /35 ²)	49828	46.7	4.423	3.463
(1 x 400 ² /35 ²)	49829	53.2	6.167	4.362

Additional types upon request.



More information:
traxline.de

tsubaki-kabelschlepp.com

Technical support:
technik@kabelschlepp.de

TRAXLINE® POWER ONE HEAVY DUTY 6.7/11 KV

Shielded continuous bending hi-flex PUR high performance cables

Definition
from page 164

Technical Information
from page 178

Technical support:
Fon: +49 (0)2762 4003-0

online-engineer.de
Cable Carrier Configurator



Picture obtainable.



Up to 1 Million
Motion cycles



Up to 1000 m
Travel length



General information

- Power supply for big electrical applications and drives
- Good EMC-protection by overall-shield
- For small bending radii and very long travel distance
- Side pressure strength, tear propagation strength and cut resistant
- Outer jacket pressure extruded and high abrasion resistant

Norms and standards

- Oil-resistant
- UV-resistant
- Ozone-resistant
- Silicone-free
- CFC-free
- REACH/RoHS II
- Flame-retardant
- NEK 606
- Halogen-free

Design

Conductor:	Class 6
Core insulation:	EPR
Core identification:	Black
Core stranding:	Wire bundles
Inner jacket:	TPE
Shield:	Shielded
Jacket color:	Red
Outer jacket:	PUR

Technical data

Temperature range while moved:	-35 up to +80 °C
Minimum bend radius while moved:	$KR_{min} \geq 7.5 \times \varnothing$
V_{max} supported:	10 m/s
V_{max} gliding:	6 m/s
a_{max} supported:	50 m/s ²
a_{max} gliding:	20 m/s ²
Insulation resistance:	> 20 MΩ x km
Nominal voltage power core(s):	according to VDE 6.7/11 KV

Varying parameters possible

High voltage cables single core | Type selection

High
voltage
cables

TRAXLINE® POWER ONE HEAVY DUTY 6.7/11 KV – Shielded

Core number x Cross-section [mm ²]	Part no.	max. Ø [mm]	Cable weight [kg/m]	Copper weight [kg/m]
(1 x 10 ² /10 ²)	49837	22.4	0.626	0.245
(1 x 16 ² /16 ²)	49838	24.0	0.753	0.371
(1 x 25 ² /16 ²)	49839	25.4	0.889	0.460
(1 x 35 ² /16 ²)	49840	27.3	1.097	0.548
(1 x 50 ² /16 ²)	49841	28.9	1.308	0.725
(1 x 70 ² /16 ²)	49842	31.1	1.514	0.926
(1 x 95 ² /16 ²)	49843	33.4	1.748	1.170
(1 x 120 ² /25 ²)	49844	36.3	2.083	1.557
(1 x 150 ² /25 ²)	49845	39.0	2.553	1.856
(1 x 185 ² /25 ²)	49846	41.0	3.026	2.554
(1 x 240 ² /25 ²)	49847	44.2	3.657	3.164
(1 x 300 ² /35 ²)	49848	47.7	4.367	3.480
(1 x 400 ² /35 ²)	49849	54.2	6.245	4.381

Additional types upon request.



More information:
traxline.de

tsubaki-kabelschlepp.com

Technical support:
technik@kabelschlepp.de

TRAXLINE® POWER ONE HEAVY DUTY 7.2/12 KV

Shielded continuous bending hi-flex PUR high performance cables

Definition
from page 164

Technical Information
from page 178

Technical support:
Fon: +49 (0)2762 4003-0

online-engineer.de
Cable Carrier Configurator



Picture obtainable.



Up to 1 Million
Motion cycles



Up to 1000 m
Travel length



General information

- Power supply for big electrical applications and drives
- Good EMC-protection by overall-shield
- For small bending radii and very long travel distance
- Side pressure strength, tear propagation strength and cut resistant
- Outer jacket pressure extruded and high abrasion resistant

Norms and standards

- Oil-resistant
- UV-resistant
- Ozone-resistant
- Silicone-free
- CFC-free
- REACH/RoHS II
- Flame-retardant
- NEK 606
- Halogen-free

Design

Conductor: Class 6

Core insulation: EPR

Core identification: Black

Core stranding: Wire bundles

Inner jacket: TPE

Shield: Shielded

Jacket color: Red

Outer jacket: PUR

Technical data

Temperature range while moved: -35 up to +80 °C

Minimum bend radius while moved: $KR_{min} \geq 7.5 \times \emptyset$

V_{max} supported: 10 m/s

V_{max} gliding: 6 m/s

a_{max} supported: 50 m/s²

a_{max} gliding: 20 m/s²

Insulation resistance: > 20 MΩ x km

Nominal voltage power core(s): according to VDE 7.2/12 KV

Varying parameters possible

High voltage cables single core | Type selection

High
voltage
cables

TRAXLINE® POWER ONE HEAVY DUTY 7.2/12 KV – Shielded

Core number x Cross-section [mm ²]	Part no.	max. Ø [mm]	Cable weight [kg/m]	Copper weight [kg/m]
(1 x 10 ² /10 ²)	49857	22.8	0.630	0.246
(1 x 16 ² /16 ²)	49858	24.6	0.770	0.373
(1 x 25 ² /16 ²)	49859	26.0	0.909	0.462
(1 x 35 ² /16 ²)	49860	27.8	1.116	0.578
(1 x 50 ² /16 ²)	49861	29.5	1.335	0.729
(1 x 70 ² /16 ²)	49862	31.8	1.561	0.930
(1 x 95 ² /16 ²)	49863	34.0	1.797	1.176
(1 x 120 ² /25 ²)	49864	36.9	2.134	1.565
(1 x 150 ² /25 ²)	49865	39.6	2.632	1.865
(1 x 185 ² /25 ²)	49866	41.6	3.086	2.566
(1 x 240 ² /25 ²)	49867	44.8	3.719	3.179
(1 x 300 ² /35 ²)	49868	48.3	4.425	3.497
(1 x 400 ² /35 ²)	49869	54.8	6.326	4.400

Additional types upon request.



More information:
traxline.de

tsubaki-kabelschlepp.com

Technical support:
technik@kabelschlepp.de

TRAXLINE®

Data cables



Trademarks are legally protected for the TSUBAKI
KABELSCHLEPP GmbH as a national or international
registration in the following countries:
tsubaki-kabelschlepp.com / trademarks

Subject to change.

DATA 400 C

Page 70



Outer jacket: PVC
 Shield: Shielded
 Flexibility: hi-flex
 Demands: demanding/
 high demanding
 Up to motion cycles: 4 Million
 Travel length up to: 50 m

DATA 700

Page 72



Outer jacket: PUR
 Shield: Unshielded
 Flexibility: hi-flex
 Demands: high demanding
 Up to motion cycles: 7 Million
 Travel length up to: 200 m

DATA 700 TPi C

Page 74



Outer jacket: PUR
 Shield: Shielded
 Flexibility: hi-flex
 Demands: high demanding
 Up to motion cycles: 7 Million
 Travel length up to: 200 m

DATA 700 TPi CD

Page 76



Outer jacket: PUR
 Shield: Double shielded
 Flexibility: hi-flex
 Demands: high demanding
 Up to motion cycles: 7 Million
 Travel length up to: 500 m

DATA 700 TPi CD 1 kV

Page 78



Outer jacket: PUR
 Shield: Double shielded
 Flexibility: hi-flex
 Demands: high demanding
 Up to motion cycles: 7 Million
 Travel length up to: 500 m

DATA 1000 TPi C TPE

Page 80



Outer jacket: TPE
 Shield: Shielded
 Flexibility: hi-flex
 Demands: very high demanding
 Up to motion cycles: 10 Million
 Travel length up to: 400 m

More information:
traxline.de

tsubaki-kabelschlepp.com

Technical support:
technik@kabelschlepp.de

TRAXLINE® DATA 400 C

Shielded continuous bending hi-flex PVC control cables

Definition
from page 164

Picture obtainable.

Technical Information
from page 178Up to **4 Million**
Motion cyclesUp to **50 m**
Travel lengthTechnical support:
Fon: +49 (0)2762 4003-0**General information**

- Communication between transmitter and receiver
- Transmission of information
- Good EMC-protection by overall-shield
- Outer jacket pressure extruded and high abrasion resistant
- Inner jacket valley-sealed extruded

Norms and standards

- Oil-resistant
- UV-resistant
- Ozone-resistant
- Silicone-free
- CFC-free
- REACH/RoHS II
- Flame-retardant

Design

Conductor:	Class 6
Core insulation:	PP/9Y
Core identification:	Color coded as per DIN 47100
Core stranding:	Bundle stranded (> 8 cores) Layer stranded (≤ 8 cores)
Inner jacket:	PVC
Shield:	Shielded
Jacket color:	Black
Outer jacket:	PVC

Technical data

Temperature range while moved:	-5 up to +80 °C (-5 up to +80 °C UL)
Minimum bend radius while moved:	$KR_{min} \geq 7.5 \times \varnothing$
V_{max} supported:	5 m/s
V_{max} gliding:	5 m/s
a_{max} supported:	50 m/s ²
a_{max} gliding:	50 m/s ²
Insulation resistance:	> 30 MΩ x km
Nominal voltage control core(s):	according to VDE 0.30/0.50 kV according to UL 0.30 kV

Varying parameters possible

TRAXLINE® DATA 400 C – Shielded

Core number x Cross-section [mm ²]	Part no.	max. Ø [mm]	Cable weight [kg/m]	Copper weight [kg/m]
(4 x 0.25 ²)	48623	6.9	0.062	0.029
(8 x 0.25 ²)	48627	8.4	0.093	0.056
(25 x 0.25 ²)	48638	12.7	0.212	0.134
(4 x 0.34 ²)	48647	7.3	0.071	0.041
(5 x 0.34 ²)	48648	7.7	0.079	0.046
(7 x 0.34 ²)	48649	8.5	0.099	0.058

Additional types upon request.



More information:
traxline.de

tsubaki-kabelschlepp.com

Technical support:
technik@kabelschlepp.de

TRAXLINE® DATA 700

Unshielded continuous bending hi-flex PUR control cables

Definition
from page 164Technical Information
from page 178Technical support:
Fon: +49 (0)2762 4003-0online-engineer.de
Cable Carrier Configurator

Picture obtainable.

Up to **7 Million**
Motion cyclesUp to **200 m**
Travel length

General information

- Communication between transmitter and receiver
- Transmission of information
- Outer jacket valley-sealed extruded and high abrasion resistant

Norms and standards

- Oil-resistant
- UV-resistant
- Ozone-resistant
- Silicone-free
- CFC-free
- REACH/RoHS II
- Flame-retardant
- NEK 606
- Halogen-free

Design

Conductor:	Class 6
Core insulation:	PP/9Y
Core identification:	Color coded as per DIN 47100
Core stranding:	Bundle stranded (> 8 cores) Layer stranded (≤ 8 cores)
Shield:	Unshielded
Jacket color:	Black
Outer jacket:	PUR

Technical data

Temperature range while moved:	-35 up to +90 °C (-35 up to +80 °C UL)
Minimum bend radius while moved:	$KR_{min} \geq 7.5 \times \varnothing$
V_{max} supported:	20 m/s
V_{max} gliding:	5 m/s
a_{max} supported:	50 m/s ²
a_{max} gliding:	50 m/s ²
Insulation resistance:	> 30 MΩ x km
Nominal voltage control core(s):	according to VDE 0.30/0.50 kV according to UL 0.30 kV

Varying parameters possible

TRAXLINE® DATA 700 – Unshielded

Core number x Cross-section [mm ²]	Part no.	max. Ø [mm]	Cable weight [kg/m]	Copper weight [kg/m]
6 x 0.25 ²	45355	6.1	0.046	0.014
7 x 0.25 ²	45356	6.4	0.048	0.017
8 x 0.25 ²	45357	6.8	0.054	0.019
9 x 0.25 ²	45358	7.2	0.060	0.023
10 x 0.25 ²	45359	7.6	0.070	0.024
12 x 0.25 ²	45360	8.4	0.084	0.029
15 x 0.25 ²	45361	9.1	0.098	0.039
3 x 0.34 ²	45372	5.3	0.034	0.010
4 x 0.34 ²	45373	5.6	0.039	0.014
5 x 0.34 ²	45374	6.0	0.046	0.017
7 x 0.34 ²	45376	6.9	0.062	0.024
8 x 0.34 ²	45377	7.4	0.070	0.027
12 x 0.34 ²	45380	9.1	0.103	0.041
15 x 0.34 ²	45382	9.9	0.122	0.053

Additional types upon request.



More information:
traxline.de

tsubaki-kabelschlepp.com

Technical support:
technik@kabelschlepp.de

TRAXLINE® DATA 700 TPI C

Shielded continuous bending hi-flex PUR data cables

Definition
from page 164**CU BRAIDED COVER**
*tinned with high flexibility***PP CORE INSULATION**
*hi-flex design,
low capacitance***PUR OUTER JACKET**
*pressure-extruded, hi-flex design,
high abrasion resistant***TPE INNER JACKET**
*valley-sealed-extruded,
hi-flex design***TWISTED PAIR
STRANDING**
for safe data transmission

Picture obtainable.

Technical Information
from page 178Up to **7 Million**
Motion cyclesUp to **200 m**
Travel length

Technical support:

Fon: +49 (0)2762 4003-0

General information

- Communication between transmitter and receiver
- Transmission of information
- Good EMC-protection by overall-shield
- Pair twisted cores reducing common mode interferences
- Outer jacket pressure extruded and high abrasion resistant
- Inner jacket valley-sealed extruded

Norms and standards

- Oil-resistant
- UV-resistant
- Ozone-resistant
- Silicone-free
- CFC-free
- REACH/RoHS II
- Flame-retardant
- NEK 606
- Halogen-free

Design

Conductor:	Class 6
Core insulation:	PP/9Y
Core identification:	Color coded as per DIN 47100
Core stranding:	Cores pair twisted in short pitches with minimal torsion
Inner jacket:	TPE
Shield:	Shielded
Jacket color:	Black
Outer jacket:	PUR

Technical data

Temperature range while moved:	-35 up to +90 °C (-35 up to +80 °C UL)
Minimum bend radius while moved:	$KR_{min} \geq 7.5 \times \varnothing$
V_{max} supported:	20 m/s
V_{max} gliding:	5 m/s
a_{max} supported:	50 m/s ²
a_{max} gliding:	50 m/s ²
Insulation resistance:	> 30 MΩ x km
Nominal voltage control core(s):	according to VDE 0.30/0.50 kV according to UL 0.30 kV

Varying parameters possible

Subject to change.

TRAXLINE® DATA 700 TPI C – Shielded

Core number x Cross-section [mm ²]	Part no.	max. Ø [mm]	Cable weight [kg/m]	Copper weight [kg/m]
(1 x 2 x 0.25 ²)	45622	6.5	0.046	0.016
(2 x 2 x 0.25 ²)	45623	8.1	0.075	0.023
(3 x 2 x 0.25 ²)	45624	8.6	0.086	0.037
(4 x 2 x 0.25 ²)	45625	9.2	0.104	0.045
(5 x 2 x 0.25 ²)	45626	9.8	0.127	0.057
(6 x 2 x 0.25 ²)	45627	10.4	0.133	0.061
(8 x 2 x 0.25 ²)	45628	11.5	0.166	0.086
(10 x 2 x 0.25 ²)	45629	13.1	0.196	0.095
(12 x 2 x 0.25 ²)	45630	12.2	0.187	0.100
(16 x 2 x 0.25 ²)	45632	13.2	0.226	0.124
(1 x 2 x 0.5 ²)	45634	7.0	0.059	0.024
(2 x 2 x 0.5 ²)	45635	9.3	0.102	0.050
(3 x 2 x 0.5 ²)	45636	9.9	0.121	0.058
(4 x 2 x 0.5 ²)	45637	10.7	0.135	0.078
(5 x 2 x 0.5 ²)	45638	11.7	0.164	0.091
(6 x 2 x 0.5 ²)	45639	12.0	0.174	0.106
(8 x 2 x 0.5 ²)	45640	13.7	0.216	0.144
(10 x 2 x 0.5 ²)	45641	15.6	0.284	0.178
(12 x 2 x 0.5 ²)	45642	15.2	0.287	0.204
(14 x 2 x 0.5 ²)	45643	16.3	0.325	0.218
(1 x 2 x 0.75 ²)	45646	7.6	0.069	0.029
(2 x 2 x 0.75 ²)	45647	10.3	0.135	0.068
(4 x 2 x 0.75 ²)	45649	11.9	0.185	0.105
(5 x 2 x 0.75 ²)	45650	12.7	0.207	0.124
(6 x 2 x 0.75 ²)	45651	13.8	0.246	0.155
(8 x 2 x 0.75 ²)	45652	16.1	0.315	0.215
(12 x 2 x 0.75 ²)	45654	18.2	0.409	0.293

Additional types upon request.



More information:
traxline.de

tsubaki-kabelschlepp.com

Technical support:
technik@kabelschlepp.de

TRAXLINE® DATA 700 TPI CD

Double-shielded continuous bending hi-flex PUR data cables

Definition
from page 164**CU BRAIDED COVER** :
*tinned with high flexibility***PAIR SHIELD** :
*very high shield efficiency***PP CORE
INSULATION** :
*hi-flex design,
low capacitance***PUR OUTER JACKET**
*pressure-extruded, hi-flex design,
high abrasion resistant***TPE INNER JACKET**
*valley-sealed-extruded,
hi-flex design***TWISTED PAIR
STRANDING**
for safe data transmission

Picture obtainable.

Technical Information
from page 178Up to **7 Million**
Motion cyclesUp to **500 m**
Travel length

Technical support:

Fon: +49 (0)2762 4003-0

General information

- Communication between transmitter and receiver
- Transmission of information
- Very good EMC-protection by Overall-shield and pair shield
- Pair twisted cores reducing common mode interferences
- Outer jacket pressure extruded and high abrasion resistant
- Inner jacket valley-sealed extruded

Norms and standards

- Oil-resistant
- UV-resistant
- Ozone-resistant
- Silicone-free
- CFC-free
- REACH/RoHS II
- Flame-retardant
- NEK 606
- Halogen-free

Design

Conductor:	Class 6
Core insulation:	PP/9Y
Core identification:	Color coded as per DIN 47100
Core stranding:	Cores pair twisted in short pitches with minimal torsion
Inner jacket:	TPE
Shield:	Double shielded
Jacket color:	Black
Outer jacket:	PUR

Technical data

Temperature range while moved:	-35 up to +90 °C (-35 up to +80 °C UL)
Minimum bend radius while moved:	$KR_{min} \geq 7.5 \times \varnothing$
V_{max} supported:	20 m/s
V_{max} gliding:	5 m/s
a_{max} supported:	50 m/s ²
a_{max} gliding:	50 m/s ²
Insulation resistance:	> 30 MΩ x km
Nominal voltage control core(s):	according to VDE 0.30/0.50 kV according to UL 0.30 kV

Varying parameters possible

Subject to change.

TRAXLINE® DATA 700 TPI CD – Double shielded

Core number x Cross-section [mm ²]	Part no.	max. Ø [mm]	Cable weight [kg/m]	Copper weight [kg/m]
(3 x (2 x 0.25 ²))	45661	13.1	0.212	0.077
(4 x (2 x 0.5 ²))	45662	15.4	0.310	0.158
(10 x (2 x 0.5 ²))	45664	26.1	0.824	0.335
(16 x (2 x 0.5 ²))	45665	27.5	0.970	0.391

Additional types upon request.



More information:
traxline.de

tsubaki-kabelschlepp.com

Technical support:
technik@kabelschlepp.de

TRAXLINE® DATA 700 TPI CD 1 KV

Double-shielded continuous bending hi-flex PUR data cables

Definition
from page 164**CU BRAIDED COVER** :
*tinned with high flexibility***PAIR SHIELD** :
*very high shield efficiency***PP CORE
INSULATION** :
*hi-flex design,
low capacitance***PUR OUTER JACKET**
*pressure-extruded, hi-flex design,
high abrasion resistant***TPE INNER JACKET**
*valley-sealed-extruded,
hi-flex design***TWISTED PAIR
STRANDING**
for safe data transmission

Picture obtainable.

Technical Information
from page 178Up to **7 Million**
Motion cyclesUp to **500 m**
Travel length

Technical support:

Fon: +49 (0)2762 4003-0

General information

- Communication between transmitter and receiver
- Transmission of information
- Very good EMC-protection by Overall-shield and pair shield
- Pair twisted cores reducing common mode interferences
- Outer jacket pressure extruded and high abrasion resistant
- Inner jacket valley-sealed extruded

Norms and standards

- Oil-resistant
- UV-resistant
- Ozone-resistant
- Silicone-free
- CFC-free
- REACH/RoHS II
- Flame-retardant
- NEK 606
- Halogen-free

Design

Conductor:	Class 6
Core insulation:	PP/9Y
Core identification:	Black, coded with white numbers
Core stranding:	Cores pair twisted in short pitches with minimal torsion
Inner jacket:	TPE
Shield:	Double shielded
Jacket color:	Black
Outer jacket:	PUR

Technical data

Temperature range while moved:	-35 up to +90 °C (-35 up to +80 °C UL)
Minimum bend radius while moved:	$KR_{min} \geq 7.5 \times \varnothing$
V_{max} supported:	20 m/s
V_{max} gliding:	5 m/s
a_{max} supported:	50 m/s ²
a_{max} gliding:	50 m/s ²
Insulation resistance:	> 30 MΩ x km
Nominal voltage power core(s):	according to VDE 0.60/1.0 KV according to UL 1.00 KV

Varying parameters possible

Subject to change.

TRAXLINE® DATA 700 TPI CD 1 KV – Double shielded

Core number x Cross-section [mm ²]	Part no.	max. Ø [mm]	Cable weight [kg/m]	Copper weight [kg/m]
(2 x (2 x 1.5 ²))	45667	19.4	0.415	0.194
(6 x (2 x 1.5 ²))	45669	27.0	0.928	0.437
(10 x (2 x 1.5 ²))	45679	37.5	1.771	0.803

Additional types upon request.



Cable+Connector
ready to connection

More information:
traxline.de

tsubaki-kabelschlepp.com

Technical support:
technik@kabelschlepp.de

TRAXLINE® DATA 1000 TPI C TPE

Shielded continuous bending hi-flex TPE data cables

Definition
from page 164

Picture obtainable.

Technical Information
from page 178Up to **10 Million**
Motion cyclesUp to **400 m**
Travel lengthTechnical support:
Fon: +49 (0)2762 4003-0**General information**

- Communication between transmitter and receiver
- Transmission of information
- Good EMC-protection by overall-shield
- Pair twisted cores reducing common mode interferences
- Outer jacket pressure extruded and high abrasion resistant
- Inner jacket valley-sealed extruded

Norms and standards

- Oil-resistant
- UV-resistant
- Ozone-resistant
- Silicone-free
- CFC-free
- REACH/RoHS II
- Halogen-free

Design

Conductor:	Class 6
Core insulation:	PP/TPE
Core identification:	Color coded as per DIN 47100
Core stranding:	Cores pair twisted in short pitches with minimal torsion
Inner jacket:	TPE
Shield:	Shielded
Jacket color:	Black
Outer jacket:	TPE

Technical data

Temperature range while moved:	-35 up to +90 °C
Minimum bend radius while moved:	$KR_{min} \geq 5 \times \emptyset$
V_{max} supported:	20 m/s
V_{max} gliding:	5 m/s
a_{max} supported:	50 m/s ²
a_{max} gliding:	50 m/s ²
Insulation resistance:	> 30 MΩ x km
Nominal voltage control core(s):	according to VDE 0.30/0.50 kV

Varying parameters possible

Subject to change.

TRAXLINE® DATA 1000 TPI C TPE – Shielded

Core number x Cross-section [mm ²]	Part no.	max. Ø [mm]	Cable weight [kg/m]	Copper weight [kg/m]
(1 x 2 x 0.25 ²)	49622	6.4	0.047	0.016
(2 x 2 x 0.25 ²)	49623	8.0	0.078	0.023
(3 x 2 x 0.25 ²)	49624	8.5	0.089	0.037
(4 x 2 x 0.25 ²)	49625	9.1	0.108	0.045
(5 x 2 x 0.25 ²)	49626	9.8	0.127	0.057
(6 x 2 x 0.25 ²)	49627	10.4	0.133	0.061
(8 x 2 x 0.25 ²)	49628	11.5	0.166	0.086
(10 x 2 x 0.25 ²)	49629	13.1	0.196	0.095
(12 x 2 x 0.25 ²)	49630	12.2	0.187	0.100
(16 x 2 x 0.25 ²)	49632	13.2	0.226	0.124
(1 x 2 x 0.5 ²)	49634	7.0	0.063	0.032
(2 x 2 x 0.5 ²)	49635	9.2	0.106	0.050
(3 x 2 x 0.5 ²)	49636	9.9	0.121	0.058
(4 x 2 x 0.5 ²)	49637	10.7	0.139	0.078
(5 x 2 x 0.5 ²)	49638	11.4	0.171	0.091
(6 x 2 x 0.5 ²)	49639	12.2	0.191	0.106
(8 x 2 x 0.5 ²)	49640	13.6	0.220	0.142
(10 x 2 x 0.5 ²)	49641	15.5	0.295	0.178
(12 x 2 x 0.5 ²)	49642	15.1	0.289	0.204
(14 x 2 x 0.5 ²)	49643	16.2	0.353	0.218
(1 x 2 x 0.75 ²)	49646	7.9	0.085	0.029
(2 x 2 x 0.75 ²)	49647	10.3	0.135	0.068
(4 x 2 x 0.75 ²)	49649	11.9	0.187	0.105
(5 x 2 x 0.75 ²)	49650	12.4	0.216	0.124
(6 x 2 x 0.75 ²)	49651	13.9	0.251	0.155
(8 x 2 x 0.75 ²)	49652	15.9	0.348	0.215
(12 x 2 x 0.75 ²)	49654	17.8	0.433	0.293

Additional types upon request.



More information:
traxline.de

tsubaki-kabelschlepp.com

Technical support:
technik@kabelschlepp.de

TRAXLINE® BUS cables



Trademarks are legally protected for the TSUBAKI
KABELSCHLEPP GmbH as a national or international
registration in the following countries:
tsubaki-kabelschlepp.com/Trademarks

Subject to change.

PROFIBUS 700 CD

Page 84



Outer jacket: PUR
Shield: Double shielded
Flexibility: hi-flex
Demands: high demanding
Up to motion cycles: 7 Million
Travel length up to: 100 m

PROFIBUS 700 CD 90°C

Page 86



Outer jacket: PUR
Shield: Double shielded
Flexibility: hi-flex
Demands: high demanding
Up to motion cycles: 7 Million
Travel length up to: 100 m

PROFINET 700 CD

Page 88



Outer jacket: PUR
Shield: Double shielded
Flexibility: hi-flex
Demands: high demanding
Up to motion cycles: 10 Million
Travel length up to: 100 m

CAN-BUS 700 C

Page 90



Outer jacket: PUR
Shield: Shielded
Flexibility: hi-flex
Demands: high demanding
Up to motion cycles: 7 Million
Travel length up to: 200 m

USB 2.0 S 700 CD

Page 92



Outer jacket: PUR
Shield: Double shielded
Flexibility: hi-flex
Demands: high demanding
Up to motion cycles: 7 Million
Travel length up to: 5 m

USB 2.0 L 700 CD

Page 94



Outer jacket: PUR
Shield: Double shielded
Flexibility: hi-flex
Demands: high demanding
Up to motion cycles: 10 Million
Travel length up to: 10 m

USB 3.0 700 CD

Page 96



Outer jacket: PUR
Shield: Double shielded
Flexibility: hi-flex
Demands: high demanding
Up to motion cycles: 4 Million
Travel length up to: 5 m

CAT.5E 700 CD

Page 98



Outer jacket: PUR
Shield: Double shielded
Flexibility: hi-flex
Demands: high demanding
Up to motion cycles: 7 Million
Travel length up to: 60 m

CAT.6 700 CD

Page 100



Outer jacket: PUR
Shield: Double shielded
Flexibility: hi-flex
Demands: high demanding
Up to motion cycles: 7 Million
Travel length up to: 60 m

More information:
traxline.de

tsubaki-kabelschlepp.com

Technical support:
technik@kabelschlepp.de

TRAXLINE® PROFIBUS 700 CD

Double-shielded continuous bending hi-flex Profibus PUR cables

Definition
from page 164

Technical Information
from page 178

Technical support:
Fon: +49 (0)2762 4003-0

online-engineer.de
Cable Carrier Configurator



Picture obtainable.



Up to **7 Million**
Motion cycles



Up to **100 m**
Travel length



General information

- For Process Field Bus applications
- Pair twisted cores reducing common mode interferences
- Good EMC-protection by double overall-shield
- Outer jacket pressure extruded and high abrasion resistant
- Inner jacket valley-sealed extruded

Norms and standards

- Oil-resistant
- UV-resistant
- Ozone-resistant
- Silicone-free
- CFC-free
- REACH/RoHS II
- Flame-retardant
- NEK 606
- Halogen-free

Design

Conductor:	Class 6
Core insulation:	PE/02Y Foam
Core identification:	Red, green
Core stranding:	Cores pair twisted in short pitches with minimal torsion
Inner jacket:	PP/TPE
Shield:	Double-shielded
Jacket color:	Violet
Outer jacket:	PUR

Technical data

Temperature range while moved:	-40 up to +70 °C
Minimum bend radius while moved:	$KR_{min} \geq 15 \times \emptyset$
V_{max} supported:	3.5 m/s
V_{max} gliding:	2 m/s
a_{max} supported:	10 m/s ²
a_{max} gliding:	10 m/s ²
Insulation resistance:	> 10 MΩ x km
Nominal voltage control core(s):	according to VDE 0.30 kV according to UL 0.30 kV

Varying parameters possible

BUS cables | Type selection

TRAXLINE® PROFIBUS 700 CD – Double-shielded

Core number x Core diameter [mm]	Part no.	max. Ø [mm]	Cable weight [kg/m]	Copper weight [kg/m]
((1 x 2 x 0.64))	45690	8.4	0.070	0.025

Additional types upon request.



More information:
traxline.de

tsubaki-kabelschlepp.com

Technical support:
technik@kabelschlepp.de

TRAXLINE® PROFIBUS 700 CD 90°C

Double-shielded continuous bending hi-flex Profibus PUR cables

Definition from page 164

Technical Information from page 178

Technical support: Fon: +49 (0)2762 4003-0

online-engineer.de
Cable Carrier Configurator



Picture obtainable.



Up to **7 Million**
Motion cycles



Up to **100 m**
Travel length



General information

- For Process Field Bus applications
- Pair twisted cores reducing common mode interferences
- Good EMC-protection by double overall-shield
- Outer jacket pressure extruded and high abrasion resistant
- Inner jacket valley-sealed extruded

Norms and standards

- Oil-resistant
- UV-resistant
- Ozone-resistant
- Silicone-free
- CFC-free
- REACH/RoHS II
- Flame-retardant
- NEK 606
- Halogen-free

Design

Conductor:	Class 6
Core insulation:	PE/02Y Foam
Core identification:	Red, green
Core stranding:	Cores pair twisted in short pitches with minimal torsion
Inner jacket:	PP/TPE
Shield:	Double-shielded
Jacket color:	Violet
Outer jacket:	PUR

Technical data

Temperature range while moved:	-20 up to +90 °C
Minimum bend radius while moved:	$KR_{min} \geq 15 \times \emptyset$
V_{max} supported:	3.5 m/s
V_{max} gliding:	2 m/s
a_{max} supported:	10 m/s ²
a_{max} gliding:	10 m/s ²
Insulation resistance:	> 10 MΩ x km
Nominal voltage control core(s):	according to VDE 0.03 kV according to UL 0.03 kV

Varying parameters possible

BUS cables | Type selection

TRAXLINE® PROFIBUS 700 CD 90°C – Double-shielded

Core number x Core diameter [mm]	Part no.	max. Ø [mm]	Cable weight [kg/m]	Copper weight [kg/m]
((1 x 2 x 0.64))	45689	8.5	0.070	0.026

Additional types upon request.



More information:
traxline.de

tsubaki-kabelschlepp.com

Technical support:
technik@kabelschlepp.de

TRAXLINE® PROFINET 700 CD

Double-shielded continuous bending hi-flex PROFINET PUR cables

Definition from page 164

Technical Information from page 178

Technical support: Fon: +49 (0)2762 4003-0

online-engineer.de
Cable Carrier Configurator

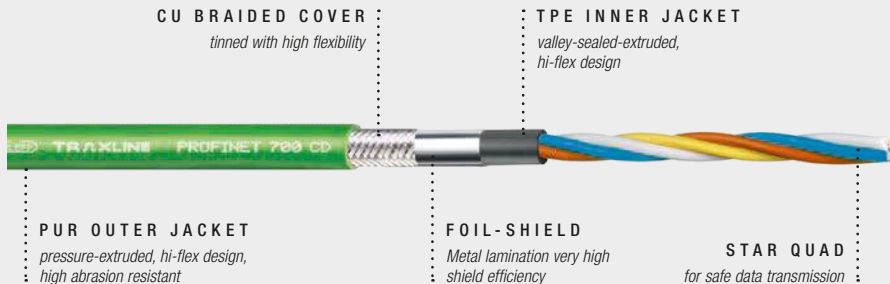

Picture obtainable.



Up to **10 Million**
Motion cycles



Up to **100 m**
Travel length



General information

- For Process Field Network applications
- In line with Ethernet standards
- Pair twisted cores reducing common mode interferences
- Good EMC-protection by double overall-shield
- Outer jacket pressure extruded and high abrasion resistant
- Inner jacket valley-sealed extruded

Norms and standards

- Oil-resistant
- UV-resistant
- Ozone-resistant
- Silicone-free
- CFC-free
- REACH/RoHS II
- Flame-retardant
- NEK 606
- Halogen-free

Design

Conductor:	Class 6
Core insulation:	PP/9Y
Core identification:	wt, ye, bl, or
Core stranding:	Cores as star quad concentrically in short pitches with minimal torsion
Inner jacket:	PP/TPE
Shield:	Double shielded
Jacket color:	Green
Outer jacket:	PUR

Technical data

Temperature range while moved:	-30 up to +70 °C
Minimum bend radius while moved:	$KR_{min} \geq 7.5 \times \emptyset$
V_{max} supported:	5 m/s
V_{max} gliding:	5 m/s
a_{max} supported:	10 m/s ²
a_{max} gliding:	10 m/s ²
Insulation resistance:	> 30 MΩ x km
Nominal voltage control core(s):	according to VDE 0.03 kV

Varying parameters possible

BUS cables | Type selection

TRAXLINE® PROFINET 700 CD – Double shielded

Core number x Cross-section [mm ²]	Part no.	max. Ø [mm]	Cable weight [kg/m]	Copper weight [kg/m]
((2 x 2 x AW G 22/19))	45692	6.9	0.065	0.037

Additional types upon request.



More information:
traxline.de

tsubaki-kabelschlepp.com

Technical support:
technik@kabelschlepp.de

TRAXLINE® CAN-BUS 700 C

Shielded continuous bending hi-flex and robust PUR bus cables

Definition
from page 164

Technical Information
from page 178

Technical support:
Fon: +49 (0)2762 4003-0

online-engineer.de
Cable Carrier Configurator

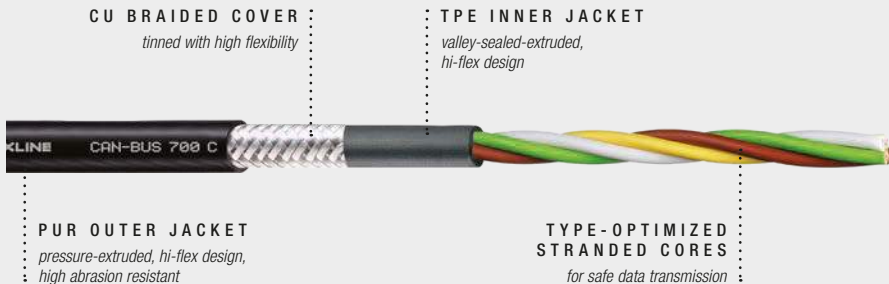

Picture obtainable.



Up to **7 Million**
Motion cycles



Up to **200 m**
Travel length



General information

- For Controller Area Network applications
- To connect several control units
- Pair twisted cores reducing common mode interferences
- Overall-shield covers from electric or magnetic fields
- Outer jacket pressure extruded and high abrasion resistant
- Inner jacket valley-sealed extruded

Norms and standards

- Oil-resistant
- UV-resistant
- Ozone-resistant
- Silicone-free
- CFC-free
- REACH/RoHS II
- Flame-retardant
- NEK 606
- Halogen-free

Design

Conductor:	Class 6
Core insulation:	PE/02Y Foam
Core identification:	br, wt
Core stranding:	Cores type-optimized stranded in short pitches with minimal torsion
Inner jacket:	PP/TPE
Shield:	Shielded
Jacket color:	Black
Outer jacket:	PUR

Technical data

Temperature range while moved:	-30 up to +80 °C
Minimum bend radius while moved:	$KR_{min} \geq 7.5 \times \emptyset$
V_{max} supported:	3 m/s
V_{max} gliding:	3 m/s
a_{max} supported:	10 m/s ²
a_{max} gliding:	10 m/s ²
Insulation resistance:	> 5000 MΩ x km
Nominal voltage control core(s):	according to VDE 0.03 kV

Varying parameters possible

Subject to change.

BUS cables | Type selection

TRAXLINE® CAN-BUS 700 C – Shielded

Core number x Cross-section [mm ²]	Part no.	max. Ø [mm]	Cable weight [kg/m]	Copper weight [kg/m]
(1 x 2 x 0.5 ²)	45670	8.6	0.087	0.034
(4 x 1 x 0.5 ²)	45672	8.4	0.093	0.045

Additional types upon request.



More information:
traxline.de

tsubaki-kabelschlepp.com

Technical support:
technik@kabelschlepp.de

TRAXLINE® USB 2.0 S 700 CD

Double-shielded continuous bending hi-flex USB PUR cables

Definition from page 164

Technical Information from page 178

Technical support:
Fon: +49 (0)2762 4003-0

online-engineer.de
Cable Carrier Configurator



Picture obtainable.



Up to **7 Million**
Motion cycles



Up to **5 m**
Travel length



General information

- For USB 2.0 applications
- Pair twisted cores reducing common mode interferences
- Good EMC-protection by double overall-shield
- Outer jacket pressure extruded and high abrasion resistant

Norms and standards

- Oil-resistant
- UV-resistant
- Ozone-resistant
- Silicone-free
- CFC-free
- REACH/RoHS II
- Flame-retardant
- NEK 606
- Halogen-free

Design

Conductor:	Class 6
Core insulation:	PP/9Y
Core identification:	wt, gn, rd, bk
Core stranding:	Cores pair twisted in short pitches with minimal torsion
Inner jacket:	PP/TPE
Shield:	Double shielded
Jacket color:	Violet
Outer jacket:	PUR

Technical data

Temperature range while moved:	-10 up to +70 °C
Minimum bend radius while moved:	$KR_{min} \geq 10 \times \emptyset$
V_{max} supported:	3.5 m/s
V_{max} gliding:	2 m/s
a_{max} supported:	10 m/s ²
a_{max} gliding:	10 m/s ²
Insulation resistance:	> 10 MΩ x km
Nominal voltage control core(s):	according to VDE 0.03 kV according to UL 0.03 kV

Varying parameters possible

BUS cables | Type selection

TRAXLINE® USB 2.0 S 700 CD – Double shielded

Core number x Cross-section [mm ²]	Part no.	max. Ø [mm]	Cable weight [kg/m]	Copper weight [kg/m]
((1 x 2 x AW G 28+2 x AW G 20))	45686	5.2	0.045	0.030

Additional types upon request.



More information:
traxline.de

tsubaki-kabelschlepp.com

Technical support:
technik@kabelschlepp.de

TRAXLINE® USB 2.0 L 700 CD

Double-shielded continuous bending hi-flex USB PUR cables

Definition from page 164

Technical Information from page 178

Technical support:
Fon: +49 (0)2762 4003-0

online-engineer.de
Cable Carrier Configurator



Picture obtainable.



Up to **7 Million**
Motion cycles



Up to **10 m**
Travel length



General information

- For USB 2.0 applications
- Pair twisted cores reducing common mode interferences
- Good EMC-protection by double overall-shield
- Outer jacket pressure extruded and high abrasion resistant

Norms and standards

- Oil-resistant
- UV-resistant
- Ozone-resistant
- Silicone-free
- CFC-free
- REACH/RoHS II
- Flame-retardant
- NEK 606
- Halogen-free

Design

Conductor:	Class 6
Core insulation:	PP/9Y
Core identification:	wt, gn, rd, bk
Core stranding:	Cores pair twisted in short pitches with minimal torsion
Inner jacket:	PP/TPE
Shield:	Double shielded
Jacket color:	Black
Outer jacket:	PUR

Technical data

Temperature range while moved:	-10 up to +70 °C
Minimum bend radius while moved:	$KR_{min} \geq 10 \times \varnothing$
V_{max} supported:	3.5 m/s
V_{max} gliding:	2 m/s
a_{max} supported:	10 m/s ²
a_{max} gliding:	10 m/s ²
Insulation resistance:	> 10 MΩ x km
Nominal voltage control core(s):	according to VDE 0.03 kV according to UL 0.03 kV

Varying parameters possible

BUS cables | Type selection

TRAXLINE® USB 2.0 L 700 CD – Double shielded

Core number x Cross-section [mm ²]	Part no.	max. Ø [mm]	Cable weight [kg/m]	Copper weight [kg/m]
((1 x 2 x AW G 24+1 x 2 x AW G 20))	45687	6.5	0.056	0.040

Additional types upon request.



More information:
traxline.de

tsubaki-kabelschlepp.com

Technical support:
technik@kabelschlepp.de

TRAXLINE® USB 3.0 700 CD

Double-shielded continuous bending hi-flex USB PUR cables

Definition from page 164

Technical Information from page 178

Technical support: Fon: +49 (0)2762 4003-0

online-engineer.de
Cable Carrier Configurator

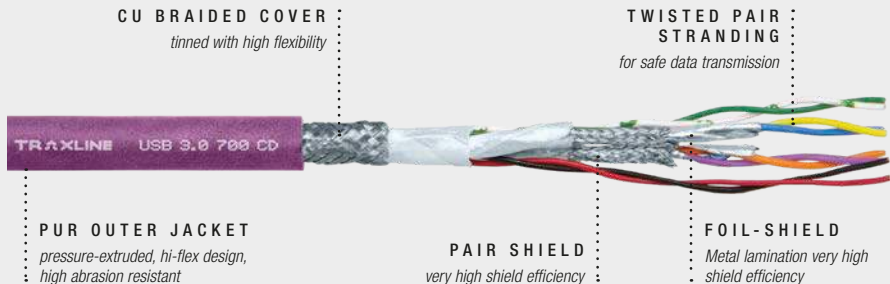

Picture obtainable.



Up to **4 Million**
Motion cycles



Up to **5 m**
Travel length



General information

- For USB 3.0 applications
- Pair twisted cores reducing common mode interferences
- Very good EMC-protection by Overall-shield and pair shield
- Outer jacket pressure extruded and high abrasion resistant

Norms and standards

- Oil-resistant
- UV-resistant
- Ozone-resistant
- Silicone-free
- CFC-free
- REACH/RoHS II
- Flame-retardant
- NEK 606
- Halogen-free

Design

Conductor:	Class 6
Core insulation:	PE/02Y Foam
Core identification:	bk, rd, or, vi, gn, gn-wt, ye, bl
Core stranding:	Cores bundled in pairs in short pitches with minimal torsion
Inner jacket:	PP/TPE
Shield:	Double shielded
Jacket color:	Violet
Outer jacket:	PUR

Technical data

Temperature range while moved:	-10 up to +70 °C
Minimum bend radius while moved:	$KR_{min} \geq 10 \times \varnothing$
V_{max} supported:	3.5 m/s
V_{max} gliding:	2 m/s
a_{max} supported:	10 m/s ²
a_{max} gliding:	10 m/s ²
Insulation resistance:	> 10 MΩ x km
Nominal voltage control core(s):	according to VDE 0.03 kV according to UL 0.05 kV

Varying parameters possible

BUS cables | Type selection

TRAXLINE® USB 3.0 700 CD – Double shielded

Core number x Cross-section [mm ²]	Part no.	max. Ø [mm]	Cable weight [kg/m]	Copper weight [kg/m]
(2 x 2 x AW G 28+2 x (1 x 2 x AW G 28))	45688	6.8	0.062	0.042

Additional types upon request.



More information:
traxline.de

tsubaki-kabelschlepp.com

Technical support:
technik@kabelschlepp.de

TRAXLINE® CAT.5E 700 CD

Double-shielded continuous bending hi-flex CAT.5E PUR cable

Definition
from page 164

Technical Information
from page 178

Technical support:
Fon: +49 (0)2762 4003-0

online-engineer.de
Cable Carrier Configurator



Picture obtainable.



Up to **7 Million**
Motion cycles



Up to **60 m**
Travel length



General information

- For Ethernet applications in line with Category 5E
- Pair twisted cores reducing common mode interferences
- Good EMC-protection by double overall-shield
- Outer jacket pressure extruded and high abrasion resistant

Norms and standards

- Oil-resistant
- UV-resistant
- Ozone-resistant
- Silicone-free
- CFC-free
- REACH/RoHS II
- Flame-retardant
- NEK 606
- Halogen-free

Design

Conductor:	Class 6
Core insulation:	PP/9Y
Core identification:	wt-bl, bl, wt-or, or, wt-gn, gn, wt-br, br
Core stranding:	Cores bundled in pairs in short pitches with minimal torsion
Shield:	Double shielded
Jacket color:	Green
Outer jacket:	PUR

Technical data

Temperature range while moved:	-30 up to +80 °C (-30 up to +80 °C UL)
Minimum bend radius while moved:	$KR_{min} \geq 7.5 \times \varnothing$
V_{max} supported:	3 m/s
V_{max} gliding:	3 m/s
a_{max} supported:	5 m/s ²
a_{max} gliding:	5 m/s ²
Insulation resistance:	> 30 MΩ x km
Nominal voltage control core(s):	according to VDE 0.10 kV according to UL 0.10 kV

Varying parameters possible

BUS cables | Type selection

TRAXLINE® CAT.5E 700 CD – Double shielded

Core number x Cross-section [mm ²]	Part no.	max. Ø [mm]	Cable weight [kg/m]	Copper weight [kg/m]
((4 x 2 x AW G 26))	45693	7.1	0.056	0.031

Additional types upon request.



More information:
traxline.de

tsubaki-kabelschlepp.com

Technical support:
technik@kabelschlepp.de

TRAXLINE® CAT.6 700 CD

Double-shielded continuous bending hi-flex CAT.6 PUR cable

Definition
from page 164

Technical Information
from page 178

Technical support:
Fon: +49 (0)2762 4003-0

online-engineer.de
Cable Carrier Configurator



Picture obtainable.



Up to **7 Million**
Motion cycles



Up to **60 m**
Travel length



General information

- For Ethernet applications in line with Category 6
- Pair twisted cores reducing common mode interferences
- Good EMC-protection by double overall-shield
- Outer jacket pressure extruded and high abrasion resistant

Norms and standards

- Oil-resistant
- UV-resistant
- Ozone-resistant
- Silicone-free
- CFC-free
- REACH/RoHS II
- Flame-retardant
- NEK 606
- Halogen-free

Design

Conductor:	Class 6
Core insulation:	PP/9Y
Core identification:	wt-bl, bl, wt-or, or, wt-gn, gn, wt-br, br
Core stranding:	Cores bundled in pairs in short pitches with minimal torsion
Shield:	Double shielded
Jacket color:	Green
Outer jacket:	PUR

Technical data

Temperature range while moved:	-30 up to +80 °C
Minimum bend radius while moved:	$KR_{min} \geq 7.5 \times \emptyset$
V_{max} supported:	3 m/s
V_{max} gliding:	3 m/s
a_{max} supported:	5 m/s ²
a_{max} gliding:	5 m/s ²
Insulation resistance:	> 10 MΩ x km
Nominal voltage control core(s):	according to VDE 0.03 kV according to UL 0.03 kV

Varying parameters possible

BUS cables | Type selection

TRAXLINE® CAT.6 700 CD – Double shielded

Core number x Cross-section [mm ²]	Part no.	max. Ø [mm]	Cable weight [kg/m]	Copper weight [kg/m]
((4 x 2 x AW G 26))	45684	8.0	0.065	0.034

Additional types upon request.



More information:
traxline.de

tsubaki-kabelschlepp.com

Technical support:
technik@kabelschlepp.de

TRAXLINE®

Coaxial cables



Trademarks are legally protected for the TSUBAKI
KABELSCHLEPP GmbH as a national or international
registration in the following countries:
tsubaki-kabelschlepp.com/Trademarks

Subject to change.

Coaxial cables | Overview

KOAX 700 C 50 Ohm

Page 104



Outer jacket: PUR
Shield: Shielded
Flexibility: hi-flex
Demands: high demanding
Up to motion cycles: 2 Million
Travel length up to: 50 m

KOAX 700 C 75 Ohm

Page 106



Outer jacket: PUR
Shield: Shielded
Flexibility: hi-flex
Demands: high demanding
Up to motion cycles: 2 Million
Travel length up to: 50 m

KOAX 700 CD 50 Ohm

Page 108



Outer jacket: PUR
Shield: Double shielded
Flexibility: hi-flex
Demands: high demanding
Up to motion cycles: 2 Million
Travel length up to: 50 m

KOAX 700 CD 75 Ohm

Page 110



Outer jacket: PUR
Shield: Double shielded
Flexibility: hi-flex
Demands: high demanding
Up to motion cycles: 2 Million
Travel length up to: 50 m

More information:
traxline.de

tsubaki-kabelschlepp.com

Technical support:
technik@kabelschlepp.de

TRAXLINE® KOAX 700 C 50 OHM

Shielded continuous bending hi-flex PUR data cables

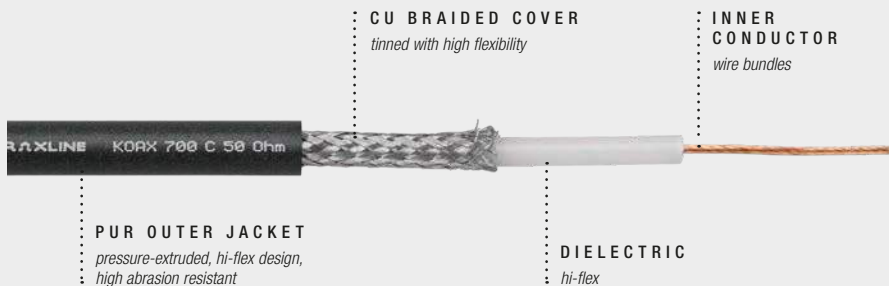
Definition
from page 164Technical Information
from page 178Technical support:
Fon: +49 (0)2762 4003-0online-engineer.de
Cable Carrier Configurator

Picture obtainable.

Up to **2 Million**
Motion cyclesUp to **50 m**
Travel length

General information

- For transmission of visual and audio data
- Overall-shield covers from electric or magnetic fields
- Outer jacket pressure extruded and high abrasion resistant

Norms and standards

- Oil-resistant
- UV-resistant
- Ozone-resistant
- Silicone-free
- CFC-free
- REACH/RoHS II
- Flame-retardant
- NEK 606
- Halogen-free

Design

Conductor:	Class 6
Core insulation:	PP/9Y
Core identification:	Black, coded with white numbers
Core stranding:	Optimized stranding with maximum flexural strength
Shield:	Shielded
Jacket color:	Black
Outer jacket:	PUR

Technical data

Temperature range while moved:	-20 up to +70 °C
Minimum bend radius while moved:	$KR_{min} \geq 15 \times \varnothing$
V_{max} supported:	3 m/s
V_{max} gliding:	3 m/s
a_{max} supported:	3 m/s ²
a_{max} gliding:	3 m/s ²

Varying parameters possible

Coaxial cables | Type selection

TRAXLINE® KOAX 700 C 50 OHM – Shielded

Core number x Cross-section [mm ²]	Part no.	max. Ø [mm]	Cable weight [kg/m]	Copper weight [kg/m]
1 x (1HF50) 50 Ohm	45680	5.6	0.045	0.022

Additional types upon request.



More information:
traxline.de

tsubaki-kabelschlepp.com

Technical support:
technik@kabelschlepp.de

TRAXLINE® KOAX 700 C 75 OHM

Shielded continuous bending hi-flex PUR data cables

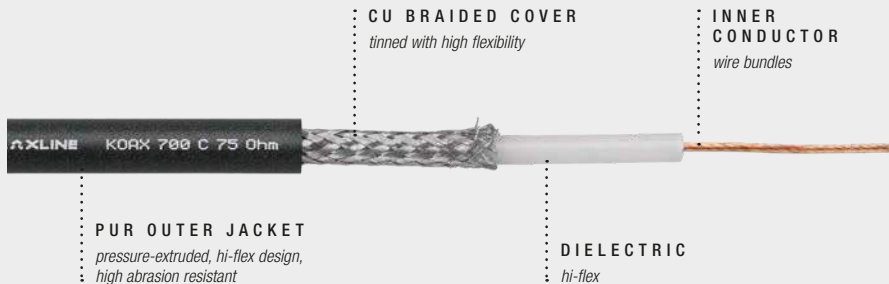
Definition
from page 164

Picture obtainable.

Technical Information
from page 178Up to 2 Million
Motion cyclesUp to 50 m
Travel length

General information

- For transmission of visual and audio data
- Overall-shield covers from electric or magnetic fields
- Outer jacket pressure extruded and high abrasion resistant

Norms and standards

- Oil-resistant
- UV-resistant
- Ozone-resistant
- Silicone-free
- CFC-free
- REACH/RoHS II
- Flame-retardant
- NEK 606
- Halogen-free

Design

Conductor:	Class 6
Core insulation:	PP/9Y
Core identification:	Black, coded with white numbers
Core stranding:	Optimized stranding with maximum flexural strength
Shield:	Shielded
Jacket color:	Black
Outer jacket:	PUR

Technical data

Temperature range while moved:	-20 up to +70 °C
Minimum bend radius while moved:	$KR_{min} \geq 15 \times \varnothing$
V_{max} supported:	3 m/s
V_{max} gliding:	3 m/s
a_{max} supported:	3 m/s ²
a_{max} gliding:	3 m/s ²

Varying parameters possible

Technical support:
Fon: +49 (0)2762 4003-0

Coaxial cables | Type selection

TRAXLINE® KOAX 700 C 75 OHM – Shielded

Core number x Cross-section [mm ²]	Part no.	max. Ø [mm]	Cable weight [kg/m]	Copper weight [kg/m]
1 x (1HF75) 75 Ohm	45691	5.6	0.060	0.018

Additional types upon request.



More information:
traxline.de

tsubaki-kabelschlepp.com

Technical support:
technik@kabelschlepp.de

TRAXLINE® KOAX 700 CD 50 OHM

Double-shielded continuous bending hi-flex PUR data cables

Definition
from page 164Technical Information
from page 178Technical support:
Fon: +49 (0)2762 4003-0online-engineer.de
Cable Carrier Configurator

Picture obtainable.

Up to **2 Million**
Motion cyclesUp to **50 m**
Travel length

General information

- For transmission of visual and audio data
- Double shielded for very good cover from electric or magnetic fields
- Outer jacket pressure extruded and high abrasion resistant

Norms and standards

- Oil-resistant
- UV-resistant
- Ozone-resistant
- Silicone-free
- CFC-free
- REACH/RoHS II
- Flame-retardant
- NEK 606
- Halogen-free

Design

Conductor:	Class 6
Core insulation:	PP/9Y
Core identification:	Black, coded with white numbers
Core stranding:	optimized stranding with maximum flexural strength
Shield:	Double shielded
Jacket color:	Black
Outer jacket:	PUR

Technical data

Temperature range while moved:	-20 up to +70 °C
Minimum bend radius while moved:	$KR_{min} \geq 15 \times \varnothing$
V_{max} supported:	3 m/s
V_{max} gliding:	3 m/s
a_{max} supported:	3 m/s ²
a_{max} gliding:	3 m/s ²

Varying parameters possible

Coaxial cables | Type selection

TRAXLINE® KOAX 700 CD 50 OHM – Double shielded

Core number x Cross-section [mm ²]	Part no.	max. Ø [mm]	Cable weight [kg/m]	Copper weight [kg/m]
(3 x (1HF50)) 50 Ohm	45683	11.2	0.140	0.063
(5 x (1HF50)) 50 Ohm	45685	14.0	0.230	0.099

Additional types upon request.



More information:
traxline.de

tsubaki-kabelschlepp.com

Technical support:
technik@kabelschlepp.de

TRAXLINE® KOAX 700 CD 75 OHM

Double-shielded continuous bending hi-flex PUR data cables

Definition
from page 164Technical Information
from page 178Technical support:
Fon: +49 (0)2762 4003-0online-engineer.de
Cable Carrier Configurator

Picture obtainable.

Up to **2 Million**
Motion cyclesUp to **50 m**
Travel length

General information

- For transmission of visual and audio data
- Double shielded for very good cover from electric or magnetic fields
- Outer jacket pressure extruded and high abrasion resistant

Norms and standards

- Oil-resistant
- UV-resistant
- Ozone-resistant
- Silicone-free
- CFC-free
- REACH/RoHS II
- Flame-retardant
- NEK 606
- Halogen-free

Design

Conductor:	Class 6
Core insulation:	PP/9Y
Core identification:	Black, coded with white numbers
Core stranding:	optimized stranding with maximum flexural strength
Shield:	Double shielded
Jacket color:	Black
Outer jacket:	PUR

Technical data

Temperature range while moved:	-20 up to +70 °C
Minimum bend radius while moved:	$KR_{min} \geq 15 \times \varnothing$
V_{max} supported:	3 m/s
V_{max} gliding:	3 m/s
a_{max} supported:	3 m/s ²
a_{max} gliding:	3 m/s ²

Varying parameters possible

Coaxial cables | Type selection

TRAXLINE® KOAX 700 CD 75 OHM – Double shielded

Core number x Cross-section [mm ²]	Part no.	max. Ø [mm]	Cable weight [kg/m]	Copper weight [kg/m]
(3 x (1HF75)) 75 Ohm	45694	11.2	0.142	0.070
(5 x (1HF75)) 75 Ohm	45695	14.0	0.234	0.089

Additional types upon request.



More information:
traxline.de

tsubaki-kabelschlepp.com

Technical support:
technik@kabelschlepp.de

TRAXLINE® Fiber optic cables



Trademarks are legally protected for the TSUBAKI
KABELSCHLEPP GmbH as a national or international
registration in the following countries:
tsubaki-kabelschlepp.com / trademarks

Subject to change.

FOC 700

Page 114



Outer jacket:	PUR
Shield:	Unshielded
Flexibility:	hi-flex
Demands:	high demanding
Up to motion cycles:	7 Million
Travel length up to:	500 m

More information:
traxline.de

tsubaki-kabelschlepp.com

Technical support:
technik@kabelschlepp.de

TRAXLINE® FOC 700

Continuous bending hi-flex multi-mode glass fiber optic metalfree PUR cable

Definition
from page 164

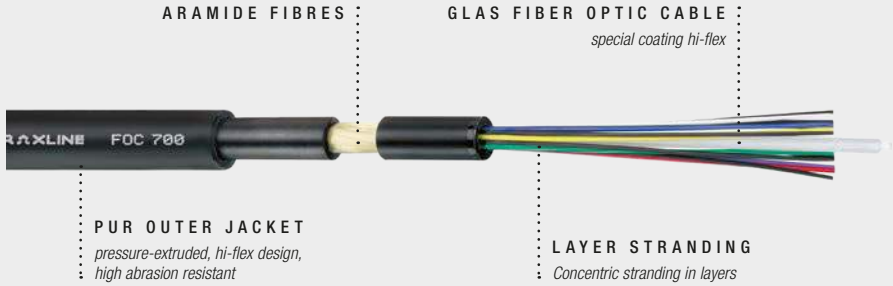

Picture obtainable.

Technical Information
from page 178



Up to **7 Million**
Motion cycles



Up to **500 m**
Travel length



General information

- For EMC-safe datatransmission
- Very high bitrate light signal transmission
- Multimode 1300 nm
- Outer jacket pressure extruded and high abrasion resistant

Norms and standards

- Oil-resistant
- UV-resistant
- Ozone-resistant
- Silicone-free
- CFC-free
- REACH/RoHS II
- NEK 606
- Halogen-free

Design

Conductor:	Glas LWL
Core insulation:	TPE
Core identification:	Black
Core stranding:	centrically around center element
Shield:	Unshielded
Jacket color:	Black
Outer jacket:	PUR

Technical data

Temperature range while moved:	-30 up to +90 °C
Minimum bend radius while moved:	$KR_{min} \geq 7.5 \times \varnothing$
V_{max} supported:	3.5 m/s
V_{max} gliding:	3.5 m/s
a_{max} supported:	10 m/s ²
a_{max} gliding:	10 m/s ²

Varying parameters possible

Technical support:
Fon: +49 (0)2762 4003-0

Fiber optic cables | Type selection

TRAXLINE® FOC 700 – Unshielded

Core number x Cross-section [mm ²]	Part no.	max. Ø [mm]	Cable weight [kg/m]
6 G 50/125 µm	45696	13.4	0.140
6 G 62.5/125 µm	45697	13.4	0.140
12 G 50/125 µm	45698	13.4	0.140
12 G 62.5/125 µm	45699	13.4	0.140

Additional types upon request.



Cable+Connector
ready to connection

More information:
traxline.de

tsubaki-kabelschlepp.com

Technical support:
technik@kabelschlepp.de

TRAXLINE®

OEM assembled cables



Trademarks are legally protected for the TSUBAKI
KABELSCHLEPP GmbH as a national or international
registration in the following countries:
tsubaki-kabelschlepp.com / trademarks

Subject to change.

SYSTEM M 700 C

Page 118



Outer jacket: PUR
Shield: Shielded
Flexibility: hi-flex
Demands: high demanding
Up to motion cycles: 5 Millionen
Travel length up to: 50 m

SYSTEM M 700 CD

Page 120



Outer jacket: PUR
Shield: Double shielded
Flexibility: hi-flex
Demands: high demanding
Up to motion cycles: 5 Millionen
Travel length up to: 50 m

SYSTEM S 700 C

Page 122



Outer jacket: PUR
Shield: Shielded
Flexibility: hi-flex
Demands: high demanding
Up to motion cycles: 5 Millionen
Travel length up to: 50 m

SYSTEM S 700 CD

Page 124



Outer jacket: PUR
Shield: Double shielded
Flexibility: hi-flex
Demands: high demanding
Up to motion cycles: 5 Millionen
Travel length up to: 50 m

More information:
traxline.de

tsubaki-kabelschlepp.com

Technical support:
technik@kabelschlepp.de

TRAXLINE® SYSTEM M 700 C

Shielded continuous bending hi-flex PUR motor/servo drive cables

Definition
from page 164Technical Information
from page 178

Technical support:

Fon: +49 (0)2762 4003-0

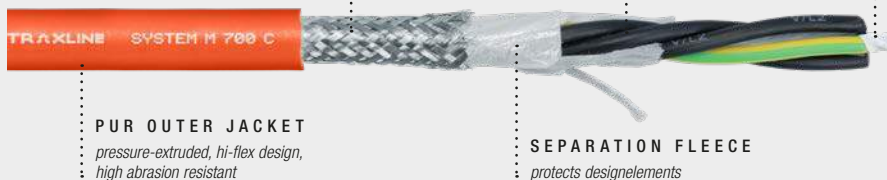
online-engineer.de
Cable Carrier ConfiguratorCU BRAIDED COVER :
*tinned with high flexibility*PP CORE INSULATION :
*hi-flex design,
low capacitance*OPTIMIZED
CENTER ELEMENT :
hi-flexPUR OUTER JACKET
*pressure-extruded, hi-flex design,
high abrasion resistant*SEPARATION FLEECE
protects designelements

Picture obtainable.

Up to 5 Million
Motion cyclesUp to 50 m
Travel length

General information

- Power supply and control for servo drives
- Alternative to Original Equipment Manufacturer
- Outer jacket pressure extruded and high abrasion resistant
- Hybrid stranded

Norms and standards

- Oil-resistant
- UV-resistant
- Ozone-resistant
- Silicone-free
- CFC-free
- REACH/RoHS II
- Flame-retardant
- NEK 606
- Halogen-free

Design

Conductor:	Class 6
Core insulation:	PP/9Y
Core identification:	Color coded as per SIEMENS OEM
Core stranding:	cores type-optimized stranded in short pitches with minimal torsion
Shield:	Shielded
Jacket color:	Orange
Outer jacket:	PUR

Technical data

Temperature range while moved:	-35 up to +90 °C (-30 up to +80 °C UL)
Minimum bend radius while moved:	KR _{min} ≥ 7.5 x Ø
V _{max} supported:	5 m/s
V _{max} gliding:	5 m/s
a _{max} supported:	50 m/s ²
a _{max} gliding:	50 m/s ²
Insulation resistance:	> 10 MΩ x km
Nominal voltage power core(s):	according to VDE 0.60/1.0 kV according to UL 1.00 kV
Nominal voltage control core(s):	according to VDE 0.60/1.0 kV according to UL 1.00 kV

Varying parameters possible

TRAXLINE® SYSTEM M 700 C – Shielded

TKG Alternative zu OEM Standard	Core number x Cross-section [mm ²]	Part no.	max. Ø [mm]	Cable weight [kg/m]	Copper weight [kg/m]
6FX8008 1BB11	(4 G 1.5 ²)	46200	9.5	0.136	0.080
6FX8008 1BB21	(4 G 2.5 ²)	46205	11.0	0.198	0.120
6FX8008 1BB31	(4 G 4 ²)	46210	12.3	0.273	0.195
6FX8008 1BB41	(4 G 6 ²)	46215	14.9	0.393	0.296
6FX8008 1BB51	(4 G 10 ²)	46220	18.2	0.616	0.445
6FX8008 1BB61	(4 G 16 ²)	46225	22.3	0.949	0.730
6FX8008 1BB25	(4 G 25 ²)	46230	26.2	1.495	1.100
6FX8008 1BB35	(4 G 35 ²)	46235	29.6	1.770	1.522
6FX8008 1BB50	(4 G 50 ²)	46240	34.4	2.530	2.165

Additional types upon request.



Cable+Connector
ready to connection

More information:
traxline.de

tsubaki-kabelschlepp.com

Technical support:
technik@kabelschlepp.de

TRAXLINE® SYSTEM M 700 CD

Double-shielded continuous bending hi-flex PUR motor/servo drive cables

Definition
from page 164

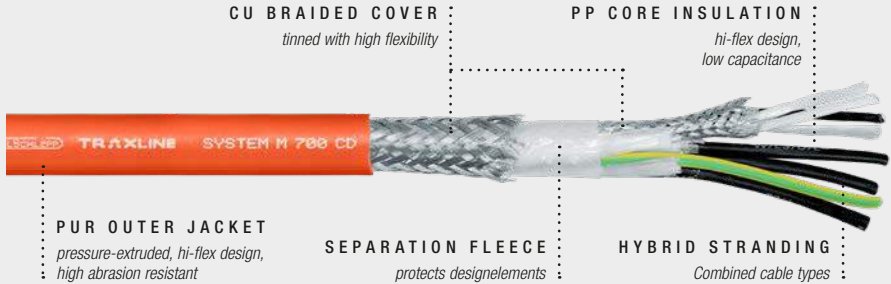

Technical Information
from page 178



Up to 5 Million
Motion cycles



Up to 50 m
Travel length



Technical support:
Fon: +49 (0)2762 4003-0

General information

- Power supply and control for servo drives
- Alternative to Original Equipment Manufacturer
- Outer jacket pressure extruded and high abrasion resistant
- Hybrid stranded

Norms and standards

- Oil-resistant
- UV-resistant
- Ozone-resistant
- Silicone-free
- CFC-free
- REACH/RoHS II
- Flame-retardant
- NEK 606
- Halogen-free

Design

Conductor:	Class 6
Core insulation:	PP/9Y
Core identification:	Color coded as per SIEMENS OEM
Core stranding:	cores type-optimized stranded in short pitches with minimal torsion
Shield:	Double shielded
Jacket color:	Orange
Outer jacket:	PUR

Technical data

Temperature range while moved:	-35 up to +90 °C (-30 up to +80 °C UL)
Minimum bend radius while moved:	$KR_{min} \geq 7.5 \times \varnothing$
V_{max} supported:	5 m/s
V_{max} gliding:	5 m/s
a_{max} supported:	50 m/s ²
a_{max} gliding:	50 m/s ²
Insulation resistance:	> 10 MΩ x km
Nominal voltage power core(s):	according to VDE 0.60/1.0 kV according to UL 1.00 kV
Nominal voltage control core(s):	according to VDE 0.60/1.0 kV according to UL 1.00 kV

Varying parameters possible

TRAXLINE® SYSTEM M 700 CD – Double shielded

TKG Alternative zu OEM Standard	Core number x Cross-section [mm ²]	Part no.	max. Ø [mm]	Cable weight [kg/m]	Copper weight [kg/m]
6FX8008 1BA11	(4 G 1.5 ² +2 x 1.5 ²)	46150	12.0	0.221	0.136
6FX8008 1BA21	(4 G 2.5 ² +2 x 1.5 ²)	46155	13.8	0.285	0.187
6FX8008 1BA31	(4 G 4 ² +2 x 1.5 ²)	46160	15.2	0.382	0.268
6FX8008 1BA41	(4 G 6 ² +2 x 1.5 ²)	46165	17.3	0.496	0.358
6FX8008 1BA51	(4 G 10 ² +2 x 1.5 ²)	46170	20.1	0.713	0.515
6FX8008 1BA61	(4 G 16 ² +2 x 1.5 ²)	46175	23.8	1.016	0.802
6FX8008 1BA25	(4 G 25 ² +2 x 1.5 ²)	46250	27.6	1.438	1.144
6FX8008 1BA35	(4 G 35 ² +2 x 1.5 ²)	46255	31.9	2.095	1.850
6FX8008 1BA50	(4 G 50 ² +2 x 1.5 ²)	46260	35.0	2.609	2.540
INK 0653	(4 G 1 ² +2 x (2 x 0.75 ²))	46300	11.3	0.194	0.136
INK 0650	(4 G 1.5 ² +2 x (2 x 0.75 ²))	46305	12.5	0.234	0.170
INK 0602	(4 G 2.5 ² +2 x (2 x 1 ²))	46315	14.3	0.327	0.229
INK 0603	(4 G 4 ² +2 x (2 x 1 ²))+2 x 1.5 ²)	46323	16.1	0.435	0.328
INK 0604	(4 G 6 ² +2 x (2 x 1 ²))+2 x 1.5 ²)	46330	17.9	0.552	0.445
INK 0605	(4 G 10 ² +2 x 1.5 ²)+2 x 1 ²)	46345	20.7	0.757	0.626
INK 0606	(4 G 16 ² +2 x (2 x 1.5 ²))	46350	24.0	1.079	0.922
INK 0607	(4 G 25 ² +2 x (2 x 1.5 ²))	46355	27.4	1.487	1.323
INK 0667	(4 G 35 ² +2 x (2 x 1.5 ²))	46360	31.0	1.951	1.621
INK 0668	(4 G 50 ² +2 x (2 x 1.5 ²))	46365	36.0	2.740	2.600

Additional types upon request.



Cable+Connector
ready to connection

More information:
traxline.de

tsubaki-kabelschlepp.com

Technical support:
technik@kabelschlepp.de

TRAXLINE® SYSTEM S 700 C

Shielded continuous bending hi-flex PUR signal feedback cables

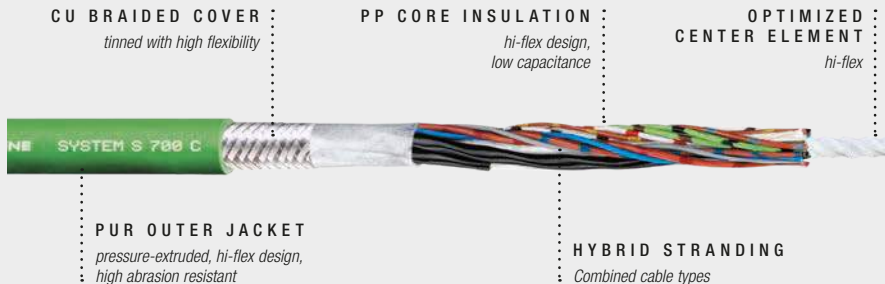
Definition
from page 164

Picture obtainable.

Technical Information
from page 178Up to 5 Million
Motion cyclesUp to 50 m
Travel length

General information

- Power supply and control for servo drives
- Alternative to Original Equipment Manufacturer
- Outer jacket pressure extruded and high abrasion resistant
- Hybrid stranded

Norms and standards

- Oil-resistant
- UV-resistant
- Ozone-resistant
- Silicone-free
- CFC-free
- REACH/RoHS II
- Flame-retardant
- NEK 606
- Halogen-free

Design

Conductor:	Class 6
Core insulation:	PP/9Y
Core identification:	Color coded as per SIEMENS OEM
Core stranding:	cores type-optimized stranded in short pitches with minimal torsion
Shield:	Shielded
Jacket color:	Green
Outer jacket:	PUR

Technical data

Temperature range while moved:	-35 up to +90 °C (-30 up to +80 °C UL)
Minimum bend radius while moved:	KR _{min} ≥ 7.5 x Ø
V_{max} supported:	5 m/s
V_{max} gliding:	5 m/s
a_{max} supported:	50 m/s ²
a_{max} gliding:	50 m/s ²
Insulation resistance:	> 10 MΩ x km
Nominal voltage control core(s):	according to VDE 0.30 kV according to UL 0.30 kV

Varying parameters possible

Technical support:

Fon: +49 (0)2762 4003-0

TRAXLINE® SYSTEM S 700 C – Shielded

TKG Alternative zu OEM Standard	Core number x Cross-section [mm ²]	Part no.	max. Ø [mm]	Cable weight [kg/m]	Copper weight [kg/m]
–	(5 x 2 x 0.14 ² +2 x 0.5 ²)	46090	9.0	0.093	0.072
6FX8008 1BD11	(8 x 2 x 0.18 ²)	46100	8.0	0.088	0.054
6FX8008 2DC00	(2 x 2 x 0.20 ² +1 x 2 x 0.38 ²)	46104	7.1	0.072	0.041
6FX8008 1BD21	(4 x 2 x 0.34 ² +4 x 0.5 ²)	46105	9.1	0.116	0.083
6FX8008 1BD61	(4 x 2 x 0.18 ²)	46125	6.6	0.060	0.035
6FX8008 1BD71	(2 x 2 x 0.18 ²)	46130	5.2	0.038	0.024
6FX8008 1BD81	(12 x 0.22 ²)	46135	7.1	0.076	0.065
INK 0448	(4 x 2 x 0.25 ² +2 x 0.5 ²)	46400	8.8	0.103	0.051
INK 0209	(4 x 2 x 0.25 ² +2 x 1 ²)	46410	9.1	0.118	0.064
–	(4 x 2 x 0.14 ² +4 x 0.5 ²)	46505	8.8	0.102	0.052

Additional types upon request.



Cable+Connector
ready to connection

More information:
traxline.de

tsubaki-kabelschlepp.com

Technical support:
technik@kabelschlepp.de

TRAXLINE® SYSTEM S 700 CD

Double-shielded continuous bending hi-flex PUR signal feedback cables

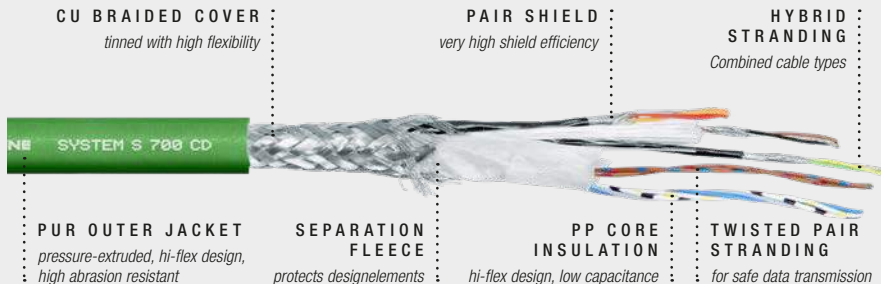
Definition
from page 164

Picture obtainable.

Technical Information
from page 178Up to 5 Million
Motion cyclesUp to 50 m
Travel length

General information

- Power supply and control for servo drives
- Alternative to Original Equipment Manufacturer
- Outer jacket pressure extruded and high abrasion resistant
- Hybrid stranded

Norms and standards

- Oil-resistant
- UV-resistant
- Ozone-resistant
- Silicone-free
- CFC-free
- REACH/RoHS II
- Flame-retardant
- NEK 606
- Halogen-free

Design

Conductor:	Class 6
Core insulation:	PP/9Y
Core identification:	Color coded as per SIEMENS OEM
Core stranding:	cores type-optimized stranded in short pitches with minimal torsion
Shield:	Double shielded
Jacket color:	Green
Outer jacket:	PUR

Technical data

Temperature range while moved:	-35 up to +90 °C (-30 up to +80 °C UL)
Minimum bend radius while moved:	$KR_{min} \geq 7.5 \times \varnothing$
V_{max} supported:	5 m/s
V_{max} gliding:	5 m/s
a_{max} supported:	50 m/s ²
a_{max} gliding:	50 m/s ²
Insulation resistance:	> 10 MΩ x km
Nominal voltage control core(s):	according to VDE 0.30 kV according to UL 0.30 kV

Varying parameters possible

Technical support:
Fon: +49 (0)2762 4003-0

TRAXLINE® SYSTEM S 700 CD – Double shielded

TKG Alternative zu OEM Standart	Core number x Cross-section [mm ²]	Part no.	max. Ø [mm]	Cable weight [kg/m]	Copper weight [kg/m]
6FX8008 1BD31	(3 x (2 x 0.14 ²)+2 x (0.5 ²))	46110	9.2	0.125	0.074
6FX8008 1BD41	(3 x (2 x 0.14 ²)+4 x 0.14 ² +2 x 0.5 ²)	46115	9.0	0.110	0.066
6FX8008 1BD51	(3 x (2 x 0.14 ²)+4 x 0.14 ² +4 x 0.23 ² +2 x 0.5 ²)	46120	9.6	0.129	0.075
INK 0280	(3 x 0.25 ² +3 x (2 x 0.25 ²)+2 x 1 ²)	46412	9.3	0.130	0.084
INK 0532	(2 x 0.14 ² +(4 x 0.14 ²)+4 x 1 ²)	46415	9.8	0.140	0.081

Additional types upon request.



Cable+Connector
ready to connection

More information:
traxline.de

tsubaki-kabelschlepp.com

Technical support:
technik@kabelschlepp.de

Assembled OEM high flex cables



Trademarks are legally protected for the TSUBAKI
KABELSCHLEPP GmbH as a national or international
registration in the following countries:
tsubaki-kabelschlepp.com/ Trademarks

Subject to change.

You need connection-ready harnessed **bus cables**? Or harnessed **signal- or power cables** for drives – in accordance to OEM specifications?

Simply order by quoting just the **OEM order number and cable length**, and wait for your checked top quality goods to arrive.

Connection-ready harnessed cables

- easy to order with just order number and cable length
- in accordance to OEM specifications
- Just-in-time delivery of three work days
- checked and monitored for reliable connection

Properties of the cables used:



Power cables according to SIEMENS

Page 128



Power cables according to BOSCH REXROTH

Page 142



Power cables according to LENZE

Page 147



Power cables according to SEW

Page 151



Other OEM cables

Page 158



USB 2.0 700 CD / USB 3.0 CD

Page 160



KOAX 700

Page 162



Signal cables according to SIEMENS

Page 139



Signal cables according to BOSCH REXROTH

Page 145



Signal cables according to LENZE

Page 150



Signal cables according to SEW

Page 156



CAT.5E / CAT.6 700 CD

Page 161



FOC 700

Page 163



More information:
traxline.de

tsubaki-kabelschlepp.com

Technical support:
technik@kabelschlepp.de

Power cables assembled to SIEMENS®

Shielded continuous bending hi-flex cables

Definition
from page 164

Properties of the cables:

- UV-resistant
- CFC-free
- Minimum bend radius
7.5 x Ø
- Halogen-free
- Flame-retardant
- Approvals:
cURus,
based on VDE,
REACH/RoHS II

Technical Information
from page 178

Power basic cables assembled to SIEMENS® 6FX8002



Picture obtainable.

Siemens® Assembling	Core number x Cross-section [mm ²]	max. Ø [mm]	Connection Motor	Connection Controller	Cable weight [kg/m]	Copper weight [kg/m]
6FX8002-5CG01	(4 G 1.5 ²)	9.5	1 ÜWM	open end	0.136	0.080
6FX8002-5CG11	(4 G 2.5 ²)	11.0	1 ÜWM	open end	0.198	0.120
6FX8002-5CG10	(4 G 1.5 ²)	9.5	1 Speedtec	open end	0.136	0.080
6FX8002-5CG12	(4 G 2.5 ²)	11.0	1 Speedtec	open end	0.198	0.120
6FX8002-5CG21	(4 G 1.5 ²)	9.5	1.5 ÜWM	open end	0.136	0.080
6FX8002-5CG31	(4 G 2.5 ²)	11.0	1.5 ÜWM	open end	0.198	0.120
6FX8002-5CG41	(4 G 4 ²)	12.3	1.5 ÜWM	open end	0.273	0.195
6FX8002-5CG51	(4 G 6 ²)	14.9	1.5 ÜWM	open end	0.393	0.296
6FX8002-5CG61	(4 G 10 ²)	18.2	1.5 ÜWM	open end	0.616	0.445
6FX8002-5CG22	(4 G 1.5 ²)	9.5	1.5 Speedtec	open end	0.136	0.080
6FX8002-5CG32	(4 G 2.5 ²)	11.0	1.5 Speedtec	open end	0.198	0.120
6FX8002-5CG42	(4 G 4 ²)	12.3	1.5 Speedtec	open end	0.273	0.195
6FX8002-5CG52	(4 G 6 ²)	14.9	1.5 Speedtec	open end	0.393	0.296
6FX8002-5CG62	(4 G 10 ²)	18.2	1.5 Speedtec	open end	0.616	0.445
6FX8002-5CG13	(4 G 10 ²)	18.2	3 ÜWM	open end	0.616	0.445
6FX8002-5CG23	(4 G 16 ²)	22.3	3 ÜWM	open end	0.949	0.730

Additional types upon request.

Varying parameters possible.
ÜWM = coupling nut with full thread

Technical support:
Fon: +49 (0)2762 4003-0

Assembled cables | Type selection

Power basic cables assembled to SIEMENS® 6FX8002



Siemens® Assembling	Core number x Cross-section [mm ²]	max. Ø [mm]	Connection Motor	Connection Controller	Cable weight [kg/m]	Copper weight [kg/m]
6FX8002-5DG01	(4 G 1.5 ² + (2 x 1.5 ²))	12	1 ÜWM	open end	0.221	0.136
6FX8002-5DG11	(4 G 2.5 ² + (2 x 1.5 ²))	13.8	1 ÜWM	open end	0.285	0.187
6FX8002-5DG10	(4 G 1.5 ² + (2 x 1.5 ²))	12.0	1 Speedtec	open end	0.221	0.136
6FX8002-5DG12	(4 G 2.5 ² + (2 x 1.5 ²))	13.8	1 Speedtec	open end	0.285	0.187
6FX8002-5DG21	(4 G 1.5 ² + (2 x 1.5 ²))	12.0	1.5 ÜWM	open end	0.221	0.136
6FX8002-5DG31	(4 G 2.5 ² + (2 x 1.5 ²))	13.8	1.5 ÜWM	open end	0.285	0.187
6FX8002-5DG41	(4 G 4 ² + (2 x 1.5 ²))	15.2	1.5 ÜWM	open end	0.382	0.268
6FX8002-5DG51	(4 G 6 ² + (2 x 1.5 ²))	17.3	1.5 ÜWM	open end	0.496	0.358
6FX8002-5DG61	(4 G 10 ² + (2 x 1.5 ²))	20.1	1.5 ÜWM	open end	0.713	0.515
6FX8002-5DG22	(4 G 1.5 ² + (2 x 1.5 ²))	12.0	1.5 Speedtec	open end	0.221	0.136
6FX8002-5DG32	(4 G 2.5 ² + (2 x 1.5 ²))	13.8	1.5 Speedtec	open end	0.285	0.187
6FX8002-5DG42	(4 G 4 ² + (2 x 1.5 ²))	15.2	1.5 Speedtec	open end	0.382	0.268
6FX8002-5DG52	(4 G 6 ² + (2 x 1.5 ²))	17.3	1.5 Speedtec	open end	0.496	0.358
6FX8002-5DG62	(4 G 10 ² + (2 x 1.5 ²))	20.1	1.5 Speedtec	open end	0.713	0.515
6FX8002-5DG13	(4 G 10 ² + (2 x 1.5 ²))	20.1	3 ÜWM	open end	0.713	0.515
6FX8002-5DG23	(4 G 16 ² + (2 x 1.5 ²))	23.8	3 ÜWM	open end	1.016	0.802
6FX8002-5DG33	(4 G 25 ² + (2 x 1.5 ²))	27.6	3 ÜWM	open end	1.438	1.144
6FX8002-5DG43	(4 G 35 ² + (2 x 1.5 ²))	31.9	3 ÜWM	open end	2.095	1.850

Additional types upon request.

Varying parameters possible.
ÜWM = coupling nut with full thread

Assembled cables | Type selection

Power basic cables assembled to SIEMENS® 6FX8002

Definition
from page 164Technical Information
from page 178

Siemens® Assembling	Core number x Cross-section [mm ²]	max. Ø [mm]	Connection Motor	Connection Controller	Cable weight [kg/m]	Copper weight [kg/m]
6FX8002-5CA01	(4 G 1.5 ²)	9.5	1 ÜWM	AEH	0.136	0.080
6FX8002-5CA11	(4 G 2.5 ²)	11.0	1 ÜWM	AEH	0.198	0.120
6FX8002-5CQ01	(4 G 1.5 ²)	9.5	1 Speedtec	AEH	0.136	0.080
6FX8002-5CQ11	(4 G 2.5 ²)	11.0	1 Speedtec	AEH	0.198	0.120
6FX8002-5CA21	(4 G 1.5 ²)	9.5	1.5 ÜWM	AEH	0.136	0.080
6FX8002-5CA31	(4 G 2.5 ²)	11.0	1.5 ÜWM	AEH	0.198	0.120
6FX8002-5CA41	(4 G 4 ²)	12.3	1.5 ÜWM	AEH	0.273	0.195
6FX8002-5CA51	(4 G 6 ²)	14.9	1.5 ÜWM	AEH	0.393	0.296
6FX8002-5CA61	(4 G 10 ²)	18.2	1.5 ÜWM	AEH	0.616	0.445
6FX8002-5CQ21	(4 G 1.5 ²)	9.5	1.5 Speedtec	AEH	0.136	0.08
6FX8002-5CQ31	(4 G 2.5 ²)	11.0	1.5 Speedtec	AEH	0.198	0.120
6FX8002-5CQ41	(4 G 4 ²)	12.3	1.5 Speedtec	AEH	0.273	0.195
6FX8002-5CQ51	(4 G 6 ²)	14.9	1.5 Speedtec	AEH	0.393	0.296
6FX8002-5CQ61	(4 G 10 ²)	18.2	1.5 Speedtec	AEH	0.616	0.445
6FX8002-5CS54	(4 G 6 ²)	14.9	1.5 ÜWM	RKS	0.393	0.296
6FX8002-5CS64	(4 G 10 ²)	18.2	1.5 ÜWM	RKS	0.616	0.445
6FX8002-5CS24	(4 G 16 ²)	22.3	1.5 ÜWM	RKS	0.949	0.730
6FX8002-5CN64	(4 G 10 ²)	18.2	1.5 Speedtec	RKS	0.616	0.445
6FX8002-5CS14	(4 G 10 ²)	18.2	3 ÜWM	RKS	0.616	0.445
6FX8002-5CS23	(4 G 16 ²)	22.3	3 ÜWM	RKS	0.949	0.730

Technical support:
Fon: +49 (0)2762 4003-0

Additional types upon request.

Varying parameters possible.

ÜWM = coupling nut with full thread

AEH = end sleeve

RKS = ring cable lug

Assembled cables | Type selection

Power basic cables assembled to SIEMENS® 6FX8002



Siemens® Assembling	Core number x Cross-section [mm ²]	max. Ø [mm]	Connection Motor	Connection Controller	Cable weight [kg/m]	Copper weight [kg/m]
6FX8002-5DA01	(4 G 1.5 ² + (2 x 1.5 ²))	12.0	1 ÜWM	RKS + Klemme	0.221	0.136
6FX8002-5DA11	(4 G 2.5 ² + (2 x 1.5 ²))	13.8	1 ÜWM	RKS + Klemme	0.285	0.187
6FX8002-5DQ01	(4 G 1.5 ² + (2 x 1.5 ²))	12.0	1 Speedtec	RKS + Klemme	0.221	0.136
6FX8002-5DQ11	(4 G 2.5 ² + (2 x 1.5 ²))	13.8	1 Speedtec	RKS + Klemme	0.285	0.187
6FX8002-5DA21	(4 G 1.5 ² + (2 x 1.5 ²))	12.0	1.5 ÜWM	RKS + Klemme	0.221	0.136
6FX8002-5DA31	(4 G 2.5 ² + (2 x 1.5 ²))	13.8	1.5 ÜWM	RKS + Klemme	0.285	0.187
6FX8002-5DA41	(4 G 4 ² + (2 x 1.5 ²))	15.2	1.5 ÜWM	RKS + Klemme	0.382	0.268
6FX8002-5DA51	(4 G 6 ² + (2 x 1.5 ²))	17.3	1.5 ÜWM	RKS + Klemme	0.496	0.358
6FX8002-5DA61	(4 G 10 ² + (2 x 1.5 ²))	20.1	1.5 ÜWM	RKS + Klemme	0.713	0.515
6FX8002-5DQ21	(4 G 1.5 ² + (2 x 1.5 ²))	12.0	1.5 Speedtec	RKS + Klemme	0.221	0.136
6FX8002-5DQ31	(4 G 2.5 ² + (2 x 1.5 ²))	13.8	1.5 Speedtec	RKS + Klemme	0.285	0.187
6FX8002-5DQ41	(4 G 4 ² + (2 x 1.5 ²))	15.2	1.5 Speedtec	RKS + Klemme	0.382	0.268
6FX8002-5DQ51	(4 G 6 ² + (2 x 1.5 ²))	17.3	1.5 Speedtec	RKS + Klemme	0.496	0.358
6FX8002-5DQ61	(4 G 10 ² + (2 x 1.5 ²))	20.1	1.5 Speedtec	RKS + Klemme	0.713	0.515
6FX8002-5EX11	(4 G 25 ² + (2 x 1.5 ²))	27.6	3 ÜWM	RKS + Klemme	1.438	1.144
6FX8002-5EX12	(4 G 16 ² + (2 x 1.5 ²))	23.8	3 ÜWM	RKS + Klemme	1.016	0.802
6FX8002-5DA13	(4 G 10 ² + (2 x 1.5 ²))	20.1	3 ÜWM	RKS + Klemme	0.713	0.515
6FX8002-5DA23	(4 G 16 ² + (2 x 1.5 ²))	23.8	3 ÜWM	RKS + Klemme	1.016	0.802
6FX8002-5DA33	(4 G 25 ² + (2 x 1.5 ²))	27.6	3 ÜWM	RKS + Klemme	1.438	1.144

Additional types upon request.

Varying parameters possible.
 ÜWM = coupling nut with full thread
 RKS = ring cable lug

Assembled cables | Type selection

Power basic cables assembled to SIEMENS® 6FX8002

Definition
from page 164

Picture obtainable.

Siemens® Assembling	Core number x Cross-section [mm ²]	max. Ø [mm]	Connection Motor	Connection Controller	Cable weight [kg/m]	Copper weight [kg/m]
6FX8002-5DS54	(4 G 6 ² + (2 x 1.5 ²))	17.3	1.5 ÜWM	RKS + Klemme	0.496	0.358
6FX8002-5DS64	(4 G 10 ² + (2 x 1.5 ²))	20.1	1.5 ÜWM	RKS + Klemme	0.713	0.515
6FX8002-5DN54	(4 G 6 ² + (2 x 1.5 ²))	17.3	1.5 Speedtec	RKS + Klemme	0.496	0.358
6FX8002-5DN64	(4 G 10 ² + (2 x 1.5 ²))	20.1	1.5 Speedtec	RKS + Klemme	0.713	0.515
6FX8002-5DS14	(4 G 10 ² + (2 x 1.5 ²))	20.1	3 ÜWM	RKS + Klemme	0.713	0.515
6FX8002-5DS23	(4 G 16 ² + (2 x 1.5 ²))	23.8	3 ÜWM	RKS + Klemme	1.016	0.802

Technical Information
from page 178

Additional types upon request.

Varying parameters possible.

ÜWM = coupling nut with full thread

RKS = ring cable lug

Technical support:
Fon: +49 (0)2762 4003-0

Assembled cables | Type selection

Power basic cables assembled to SIEMENS® 6FX8002



Siemens® Assembling	Core number x Cross-section [mm ²]	max. Ø [mm]	Connection Motor	Connection Controller	Cable weight [kg/m]	Copper weight [kg/m]
6FX8002-5CS06	(4 G 1.5 ²)	9.5	1 ÜWM	SINAMICS S120	0.136	0.080
6FX8002-5CS16	(4 G 2.5 ²)	11.0	1 ÜWM	SINAMICS S120	0.198	0.120
6FX8002-5CN06	(4 G 1.5 ²)	9.5	1 Speedtec	SINAMICS S120	0.136	0.080
6FX8002-5CN16	(4 G 2.5 ²)	11.0	1 Speedtec	SINAMICS S120	0.198	0.120
6FX8002-5CS26	(4 G 1.5 ²)	9.5	1.5 ÜWM	SINAMICS S120	0.136	0.080
6FX8002-5CS36	(4 G 2.5 ²)	11.0	1.5 ÜWM	SINAMICS S120	0.198	0.120
6FX8002-5CS46	(4 G 4 ²)	12.3	1.5 ÜWM	SINAMICS S120	0.273	0.195
6FX8002-5CS56	(4 G 6 ²)	14.9	1.5 ÜWM	SINAMICS S120	0.393	0.296
6FX8002-5CS66	(4 G 10 ²)	18.2	1.5 ÜWM	SINAMICS S120	0.616	0.445
6FX8002-5CN26	(4 G 1.5 ²)	9.5	1.5 Speedtec	SINAMICS S120	0.136	0.080
6FX8002-5CN36	(4 G 2.5 ²)	11.0	1.5 Speedtec	SINAMICS S120	0.198	0.120
6FX8002-5CN46	(4 G 4 ²)	12.3	1.5 Speedtec	SINAMICS S120	0.273	0.195
6FX8002-5CN56	(4 G 6 ²)	14.9	1.5 Speedtec	SINAMICS S120	0.393	0.296
6FX8002-5CN66	(4 G 10 ²)	18.2	1.5 Speedtec	SINAMICS S120	0.616	0.445

Additional types upon request.

Varying parameters possible.

Assembled cables | Type selection

Power basic cables assembled to SIEMENS® 6FX8002

Definition
from page 164

Picture obtainable.

Technical Information
from page 178

Siemens® Assembling	Core number x Cross-section [mm ²]	max. Ø [mm]	Connection Motor	Connection Controller	Cable weight [kg/m]	Copper weight [kg/m]
6FX8002-5DS06	(4 G 1.5 ² + (2 x 1.5 ²))	12.0	1 ÜWM	SINAMICS S120	0.221	0.136
6FX8002-5DS16	(4 G 2.5 ² + (2 x 1.5 ²))	13.8	1 ÜWM	SINAMICS S120	0.285	0.187
6FX8002-5DN06	(4 G 1.5 ² + (2 x 1.5 ²))	12.0	1 Speedtec	SINAMICS S120	0.221	0.136
6FX8002-5DN16	(4 G 2.5 ² + (2 x 1.5 ²))	13.8	1 Speedtec	SINAMICS S120	0.285	0.187
6FX8002-5DN26	(4 G 1.5 ² + (2 x 1.5 ²))	12.0	1.5 Speedtec	SINAMICS S120	0.221	0.136
6FX8002-5DN36	(4 G 2.5 ² + (2 x 1.5 ²))	13.8	1.5 Speedtec	SINAMICS S120	0.285	0.187
6FX8002-5DN46	(4 G 4 ² + (2 x 1.5 ²))	15.2	1.5 Speedtec	SINAMICS S120	0.382	0.268
6FX8002-5DN56	(4 G 6 ² + (2 x 1.5 ²))	17.3	1.5 Speedtec	SINAMICS S120	0.496	0.358
6FX8002-5DN66	(4 G 10 ² + (2 x 1.5 ²))	20.1	1.5 Speedtec	SINAMICS S120	0.713	0.515
6FX8002-5DS26	(4 G 1.5 ² + (2 x 1.5 ²))	12.0	1.5 ÜWM	SINAMICS S120	0.221	0.136
6FX8002-5DS36	(4 G 2.5 ² + (2 x 1.5 ²))	13.8	1.5 ÜWM	SINAMICS S120	0.285	0.187
6FX8002-5DS46	(4 G 4 ² + (2 x 1.5 ²))	15.2	1.5 ÜWM	SINAMICS S120	0.382	0.268
6FX8002-5DS56	(4 G 6 ² + (2 x 1.5 ²))	17.3	1.5 ÜWM	SINAMICS S120	0.496	0.358
6FX8002-5DS66	(4 G 10 ² + (2 x 1.5 ²))	20.1	1.5 ÜWM	SINAMICS S120	0.713	0.515

Technical support:
Fon: +49 (0)2762 4003-0

Additional types upon request.

Varying parameters possible.

ÜWM = coupling nut with full thread

Assembled cables | Type selection

Power basic cables assembled to SIEMENS® 6FX8002



Siemens® Assembling	Core number x Cross-section [mm ²]	max. Ø [mm]	Connection Motor	Connection Controller	Cable weight [kg/m]	Copper weight [kg/m]
6FX8002-5CS01	(4 G 1.5 ²)	9.5	1 ÜWM	SINAMICS S120	0.136	0.080
6FX8002-5CS11	(4 G 2.5 ²)	11.0	1 ÜWM	SINAMICS S120	0.198	0.120
6FX8002-5CN01	(4 G 1.5 ²)	9.5	1 Speedtec	SINAMICS S120	0.136	0.080
6FX8002-5CN11	(4 G 2.5 ²)	11.0	1 Speedtec	SINAMICS S120	0.198	0.120
6FX8002-5CS21	(4 G 1.5 ²)	9.5	1.5 ÜWM	SINAMICS S120	0.136	0.080
6FX8002-5CS31	(4 G 2.5 ²)	11.0	1.5 ÜWM	SINAMICS S120	0.198	0.120
6FX8002-5CS41	(4 G 4 ²)	12.3	1.5 ÜWM	SINAMICS S120	0.273	0.195
6FX8002-5CS51	(4 G 6 ²)	14.9	1.5 ÜWM	SINAMICS S120	0.393	0.296
6FX8002-5CS61	(4 G 10 ²)	18.2	1.5 ÜWM	SINAMICS S120	0.616	0.445
6FX8002-5CN21	(4 G 1.5 ²)	9.5	1.5 Speedtec	SINAMICS S120	0.136	0.080
6FX8002-5CN31	(4 G 2.5 ²)	11.0	1.5 Speedtec	SINAMICS S120	0.198	0.120
6FX8002-5CN41	(4 G 4 ²)	12.3	1.5 Speedtec	SINAMICS S120	0.273	0.195
6FX8002-5CN51	(4 G 6 ²)	14.9	1.5 Speedtec	SINAMICS S120	0.393	0.296
6FX8002-5CN61	(4 G 10 ²)	18.2	1.5 Speedtec	SINAMICS S120	0.616	0.445
6FX8002-5CS13	(4 G 10 ²)	18.2	3 ÜWM	SINAMICS S120	0.616	0.445
6FX8002-5CS12	(4 G 2.5 ²)	11.0	open end	SINAMICS S120	0.198	0.120
6FX8002-5CS42	(4 G 4 ²)	12.3	open end	SINAMICS S120	0.273	0.195
6FX8002-5CS52	(4 G 6 ²)	14.9	open end	SINAMICS S120	0.393	0.296
6FX8002-5CS62	(4 G 10 ²)	18.2	open end	SINAMICS S120	0.616	0.445

Additional types upon request.

Varying parameters possible.
ÜWM = coupling nut with full thread

Assembled cables | Type selection

Power basic cables assembled to SIEMENS® 6FX8002

Definition
from page 164

Picture obtainable.

Technical Information
from page 178

Siemens® Assembling	Core number x Cross-section [mm ²]	max. Ø [mm]	Connection Motor	Connection Controller	Cable weight [kg/m]	Copper weight [kg/m]
6FX8002-5DA20	(4 G 1.5 ² + (2 x 1.5 ²))	12.0	0.5 ÜWM	SINAMICS S120	0.221	0.136
6FX8002-5DS01	(4 G 1.5 ² + (2 x 1.5 ²))	12.0	1 ÜWM	SINAMICS S120	0.221	0.136
6FX8002-5DS11	(4 G 2.5 ² + (2 x 1.5 ²))	13.8	1 ÜWM	SINAMICS S120	0.285	0.187
6FX8002-5DN01	(4 G 1.5 ² + (2 x 1.5 ²))	12.0	1 Speedtec	SINAMICS S120	0.221	0.136
6FX8002-5DN11	(4 G 2.5 ² + (2 x 1.5 ²))	13.8	1 Speedtec	SINAMICS S120	0.285	0.187
6FX8002-5DS21	(4 G 1.5 ² + (2 x 1.5 ²))	12.0	1.5 ÜWM	SINAMICS S120	0.221	0.136
6FX8002-5DS31	(4 G 2.5 ² + (2 x 1.5 ²))	13.8	1.5 ÜWM	SINAMICS S120	0.285	0.187
6FX8002-5DS41	(4 G 4 ² + (2 x 1.5 ²))	15.2	1.5 ÜWM	SINAMICS S120	0.382	0.268
6FX8002-5DS51	(4 G 6 ² + (2 x 1.5 ²))	17.3	1.5 ÜWM	SINAMICS S120	0.496	0.358
6FX8002-5DS61	(4 G 10 ² + (2 x 1.5 ²))	20.1	1.5 ÜWM	SINAMICS S120	0.713	0.515
6FX8002-5DN21	(4 G 1.5 ² + (2 x 1.5 ²))	12.0	1.5 Speedtec	SINAMICS S120	0.221	0.136
6FX8002-5DN31	(4 G 2.5 ² + (2 x 1.5 ²))	13.8	1.5 Speedtec	SINAMICS S120	0.285	0.187
6FX8002-5DN41	(4 G 4 ² + (2 x 1.5 ²))	15.2	1.5 Speedtec	SINAMICS S120	0.382	0.268
6FX8002-5DN51	(4 G 6 ² + (2 x 1.5 ²))	17.3	1.5 Speedtec	SINAMICS S120	0.496	0.358
6FX8002-5DN61	(4 G 10 ² + (2 x 1.5 ²))	20.1	1.5 Speedtec	SINAMICS S120	0.713	0.515
6FX8002-5DS13	(4 G 10 ² + (2 x 1.5 ²))	20.1	3 ÜWM	SINAMICS S120	0.713	0.515

Additional types upon request.

Varying parameters possible.

ÜWM = coupling nut with full thread

Technical support:

Fon: +49 (0)2762 4003-0

Assembled cables | Type selection

Power extension cables assembled to SIEMENS® 6FX8002



Picture obtainable.

Siemens® Assembling	Core number x Cross-section [mm ²]	max. Ø [mm]	Connection Motor	Connection Controller	Cable weight [kg/m]	Copper weight [kg/m]
6FX8002-5CA05	(4 G 1.5 ²)	9.5	1 ÜWM	1 ÜWM	0.136	0.080
6FX8002-5CA15	(4 G 2.5 ²)	11.0	1 ÜWM	1 ÜWM	0.198	0.120
6FX8002-5CN05	(4 G 1.5 ²)	9.5	1 Speedtec	1 Speedtec	0.136	0.080
6FX8002-5CQ15	(4 G 2.5 ²)	11.0	1 Speedtec	1 Speedtec	0.198	0.120
6FX8002-5CA28	(4 G 1.5 ²)	9.5	1.5 ÜWM	1.5 ÜWM	0.136	0.080
6FX8002-5CA38	(4 G 2.5 ²)	11.0	1.5 ÜWM	1.5 ÜWM	0.198	0.120
6FX8002-5CA48	(4 G 4 ²)	12.3	1.5 ÜWM	1.5 ÜWM	0.273	0.195
6FX8002-5CA58	(4 G 6 ²)	14.9	1.5 ÜWM	1.5 ÜWM	0.393	0.296
6FX8002-5CA68	(4 G 10 ²)	18.2	1.5 ÜWM	1.5 ÜWM	0.616	0.445
6FX8002-5CQ28	(4 G 1.5 ²)	9.5	1.5 Speedtec	1.5 Speedtec	0.136	0.080
6FX8002-5CQ38	(4 G 2.5 ²)	11.0	1.5 Speedtec	1.5 Speedtec	0.198	0.120
6FX8002-5CQ48	(4 G 4 ²)	12.3	1.5 Speedtec	1.5 Speedtec	0.273	0.195
6FX8002-5CQ58	(4 G 6 ²)	14.9	1.5 Speedtec	1.5 Speedtec	0.393	0.296
6FX8002-5CQ68	(4 G 10 ²)	18.2	1.5 Speedtec	1.5 Speedtec	0.616	0.445

Additional types upon request.

Varying parameters possible.
ÜWM = coupling nut with full thread

More information:
traxline.de

tsubaki-kabelschlepp.com

Technical support:
technik@kabelschlepp.de

Extension cables

In addition to connection-ready harnessed basic cables, **extension cables** are also available. These are available as **signal and power cables** for drives – according to OEM specifications.

Simply order by quoting just the **order number and cable length**, and wait for your original quality goods to arrive.

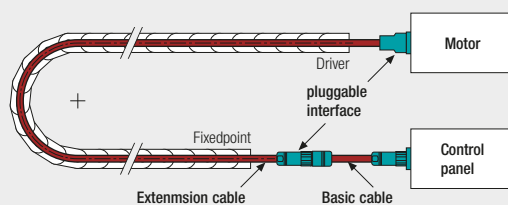

Assembled cables | Type selection

Power extension cables assembled to SIEMENS® 6FX8002

Definition
from page 164

Picture obtainable.

Technical Information
from page 178

Siemens® Assembling	Core number x Cross-section [mm ²]	max. Ø [mm]	Connection Motor	Connection Controller	Cable weight [kg/m]	Copper weight [kg/m]
6FX8002-5DA05	(4 G 1.5 ² + (2 x 1.5 ²))	12.0	1 ÜWM	1 ÜWM	0.221	0.136
6FX8002-5DA15	(4 G 2.5 ² + (2 x 1.5 ²))	13.8	1 ÜWM	1 ÜWM	0.285	0.187
6FX8002-5DN05	(4 G 1.5 ² + (2 x 1.5 ²))	12.0	1 Speedtec	1 Speedtec	0.221	0.136
6FX8002-5DQ15	(4 G 2.5 ² + (2 x 1.5 ²))	13.8	1 Speedtec	1 Speedtec	0.285	0.187
6FX8002-5DA28	(4 G 1.5 ² + (2 x 1.5 ²))	12.0	1.5 ÜWM	1.5 ÜWM	0.221	0.136
6FX8002-5DA38	(4 G 2.5 ² + (2 x 1.5 ²))	13.8	1.5 ÜWM	1.5 ÜWM	0.285	0.187
6FX8002-5DA48	(4 G 4 ² + (2 x 1.5 ²))	15.2	1.5 ÜWM	1.5 ÜWM	0.382	0.268
6FX8002-5DA58	(4 G 6 ² + (2 x 1.5 ²))	17.3	1.5 ÜWM	1.5 ÜWM	0.496	0.358
6FX8002-5DA68	(4 G 10 ² + (2 x 1.5 ²))	20.1	1.5 ÜWM	1.5 ÜWM	0.713	0.515
6FX8002-5DQ28	(4 G 1.5 ² + (2 x 1.5 ²))	12.0	1.5 Speedtec	1.5 Speedtec	0.221	0.136
6FX8002-5DQ38	(4 G 2.5 ² + (2 x 1.5 ²))	13.8	1.5 Speedtec	1.5 Speedtec	0.285	0.187
6FX8002-5DQ48	(4 G 4 ² + (2 x 1.5 ²))	15.2	1.5 Speedtec	1.5 Speedtec	0.382	0.268
6FX8002-5DQ58	(4 G 6 ² + (2 x 1.5 ²))	17.3	1.5 Speedtec	1.5 Speedtec	0.496	0.358
6FX8002-5DQ68	(4 G 10 ² + (2 x 1.5 ²))	20.1	1.5 Speedtec	1.5 Speedtec	0.713	0.515
6FX8002-5DX18	(4 G 10 ² + (2 x 1.5 ²))	20.1	3 ÜWM	3 ÜWM	0.713	0.515
6FX8002-5DX28	(4 G 16 ² + (2 x 1.5 ²))	23.8	3 ÜWM	3 ÜWM	1.016	0.802
6FX8002-5DX38	(4 G 25 ² + (2 x 1.5 ²))	27.6	3 ÜWM	3 ÜWM	1.438	1.144
6FX8002-5DX48	(4 G 35 ² + (2 x 1.5 ²))	31.9	3 ÜWM	3 ÜWM	2.095	1.850
6FX8002-5DX58	(4 G 50 ² + (2 x 1.5 ²))	35.0	3 ÜWM	3 ÜWM	2.609	2.540

Technical support:

Fon: +49 (0)2762 4003-0

Additional types upon request.

Varying parameters possible.

ÜWM = coupling nut with full thread

Signal cables assembled to SIEMENS®

Shielded continuous bending hi-flex cables

Properties of the cables:

- UV-resistant
- Halogen-free
- Approvals: cURus, based on VDE, REACH/RoHS II
- CFC-free
- Flame-retardant
- Minimum bend radius 7.5 x Ø to 10 x Ø



More information:
traxline.de

Signal basic cables assembled to SIEMENS® 6FX8002

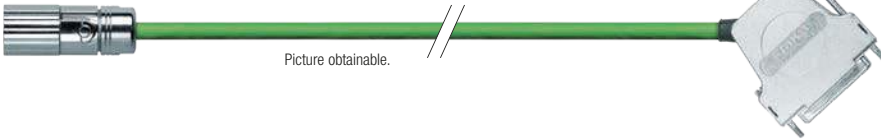

Siemens® Assembling	Core number x Cross-section [mm ²]	max. Ø [mm]	Connection Motor	Connection Controller	Cable weight [kg/m]	Copper weight [kg/m]
6FX8002-2CB31	(12 x 0.22 ²)	7.1	1 ÜWM	D-SUB	0.076	0.065
6FX8002-2CA11	(4 x 2 x 0.34 ² + 4 x 0.5 ²)	9.1	1 ÜWM	D-SUB	0.116	0.083
6FX8002-2CB51	(4 x 2 x 0.34 ² + 4 x 0.5 ²)	9.1	1 ÜWM	D-SUB	0.116	0.083
6FX8002-2CC11	(4 x 2 x 0.34 ² + 4 x 0.5 ²)	9.1	1 ÜWM	D-SUB	0.116	0.083
6FX8002-2CD01	(4 x 2 x 0.34 ² + 4 x 0.5 ²)	9.1	1 ÜWM	D-SUB	0.116	0.083
6FX8002-2CE07	(4 x 2 x 0.34 ² + 4 x 0.5 ²)	9.1	1 ÜWM	D-SUB	0.116	0.083
6FX8002-2CG00	(4 x 2 x 0.34 ² + 4 x 0.5 ²)	9.1	1 ÜWM	D-SUB	0.116	0.083
6FX8002-2CA21	(3 x (2 x 0.14 ²) + 2 x (0.5 ²))	9.2	1 ÜWM	D-SUB	0.125	0.074
6FX8002-2AD00	(3 x (2 x 0.14 ²) + 4 x 0.14 ² + 2 x 0.5 ²)	9.0	1 ÜWM	D-SUB	0.11	0.066
6FX8002-2CA15	(3 x (2 x 0.14 ²) + 4 x 0.14 ² + 2 x 0.5 ²)	9.0	1 ÜWM	D-SUB	0.11	0.066
6FX8002-2CA51	(3 x (2 x 0.14 ²) + 4 x 0.14 ² + 2 x 0.5 ²)	9.0	1 ÜWM	D-SUB	0.11	0.066
6FX8002-2CA61	(3 x (2 x 0.14 ²) + 4 x 0.14 ² + 2 x 0.5 ²)	9.0	1 ÜWM	D-SUB	0.11	0.066
6FX8002-2CF02	(3 x (2 x 0.14 ²) + 4 x 0.14 ² + 2 x 0.5 ²)	9.0	1 ÜWM	D-SUB	0.11	0.066
6FX8002-2CH00	(3 x (2 x 0.14 ²) + 4 x 0.14 ² + 2 x 0.5 ²)	9.0	1 ÜWM	D-SUB	0.11	0.066
6FX8002-2CM00	(3 x (2 x 0.14 ²) + 4 x 0.14 ² + 2 x 0.5 ²)	9.0	1 ÜWM	D-SUB	0.11	0.066
6FX8002-2CA31	(3 x (2 x 0.14 ²) + 4 x 0.14 ² + 4 x 0.23 ² + 2 x 0.5 ²)	9.6	1 ÜWM	D-SUB	0.129	0.075
6FX8002-2EQ00	(3 x (2 x 0.14 ²) + 4 x 0.14 ² + 4 x 0.23 ² + 2 x 0.5 ²)	9.6	1 ÜWM	D-SUB	0.129	0.075
6FX8002-2EQ10	(3 x (2 x 0.14 ²) + 4 x 0.14 ² + 4 x 0.23 ² + 2 x 0.5 ²)	9.6	1 ÜWM	D-SUB	0.129	0.075
6FX8002-2EQ20	(3 x (2 x 0.14 ²) + 4 x 0.14 ² + 4 x 0.23 ² + 2 x 0.5 ²)	9.6	0.5 ÜWM	D-SUB	0.129	0.075
6FX8002-2CQ31	(3 x (2 x 0.14 ²) + 4 x 0.14 ² + 4 x 0.23 ² + 2 x 0.5 ²)	9.6	1 Speedtec	D-SUB	0.129	0.075
6FX8002-2EQ31	(3 x (2 x 0.14 ²) + 4 x 0.14 ² + 4 x 0.23 ² + 2 x 0.5 ²)	9.6	1 Speedtec	D-SUB	0.129	0.075

Additional types upon request.

Varying parameters possible.
ÜWM = coupling nut with full thread

tsubaki-kabelschlepp.com

Technical support:
technik@kabelschlepp.de

Assembled cables | Type selection

Signal extension cables assembled to SIEMENS® 6FX8002

Definition from page 164



Technical Information from page 178

Siemens® Assembling	Core number x Cross-section [mm ²]	max. Ø [mm]	Connection Motor	Connection Controller	Cable weight [kg/m]	Copper weight [kg/m]
6FX8002-2CB54	$(4 \times 2 \times 0.34^2 + 4 \times 0.5^2)$	9.1	1 ÜWM	1 ÜWM	0.116	0.083
6FX8002-2AD04	$(3 \times (2 \times 0.14^2) + 4 \times 0.14^2 + 2 \times 0.5^2)$	9.0	1 ÜWM	1 ÜWM	0.11	0.066
6FX8002-2CA88	$(3 \times (2 \times 0.14^2) + 4 \times 0.14^2 + 2 \times 0.5^2)$	9.0	1 ÜWM	1 ÜWM	0.11	0.066
6FX8002-2CF04	$(3 \times (2 \times 0.14^2) + 4 \times 0.14^2 + 2 \times 0.5^2)$	9.0	1 ÜWM	1 ÜWM	0.11	0.066
6FX8002-2CM04	$(3 \times (2 \times 0.14^2) + 4 \times 0.14^2 + 2 \times 0.5^2)$	9.0	1 ÜWM	1 ÜWM	0.11	0.066
6FX8002-2CA34	$(3 \times (2 \times 0.14^2) + 4 \times 0.14^2 + 4 \times 0.23^2 + 2 \times 0.5^2)$	9.6	1 ÜWM	1 ÜWM	0.129	0.075
6FX8002-2EQ14	$(3 \times (2 \times 0.14^2) + 4 \times 0.14^2 + 4 \times 0.23^2 + 2 \times 0.5^2)$	9.6	1 ÜWM	1 ÜWM	0.129	0.075
6FX8002-2CQ34	$(3 \times (2 \times 0.14^2) + 4 \times 0.14^2 + 4 \times 0.23^2 + 2 \times 0.5^2)$	9.6	1 Speedtec	1 Speedtec	0.129	0.075

Additional types upon request.

Varying parameters possible.
ÜWM = coupling nut with full thread

Technical support:
Fon: +49 (0)2762 4003-0

Signal-Drive-CliQ-cables assembled to SIEMENS® 6FX8002

Siemens® Assembling	Core number x Cross-section [mm ²]	max. Ø [mm]	Connection Motor	Connection Controller	Cable weight [kg/m]	Copper weight [kg/m]
---------------------	--	-------------	------------------	-----------------------	---------------------	----------------------



6FX8002-2DC00	$(2 \times 2 \times 0.20^2 + 1 \times 2 \times 0.38^2)$	7.1	RJ45 IP20	RJ45 IP20	0.072	0.041
---------------	---	-----	-----------	-----------	-------	-------







6FX8002-2DC10	$(2 \times 2 \times 0.20^2 + 1 \times 2 \times 0.38^2)$	7.1	RJ45 IP20	RJ45 IP67 Plastic	0.072	0.041
---------------	---	-----	-----------	-------------------	-------	-------



6FX8002-2DC10	$(2 \times 2 \times 0.20^2 + 1 \times 2 \times 0.38^2)$	7.1	RJ45 IP20	RJ45 IP67	0.072	0.041
---------------	---	-----	-----------	-----------	-------	-------

Assembled cables | Type selection

Signal-Drive-CliQ-cables assembled to SIEMENS® 6FX8002

Siemens® Assembling	Core number x Cross-section [mm ²]	max. Ø [mm]	Connection Motor	Connection Controller	Cable weight [kg/m]	Copper weight [kg/m]
 Picture obtainable. //	$(2 \times 2 \times 0.20^2 + 1 \times 2 \times 0.38^2)$	7.1	RJ45 IP67	RJ45 IP67	0.072	0.041
 Picture obtainable. //	$(2 \times 2 \times 0.20^2 + 1 \times 2 \times 0.38^2)$	7.1	RJ45 IP20	M12 straight	0.072	0.041
 Picture obtainable. //	$(2 \times 2 \times 0.20^2 + 1 \times 2 \times 0.38^2)$	7.1	M12 gerade	M12 straight	0.072	0.041
 Picture obtainable. //	$(2 \times 2 \times 0.20^2 + 1 \times 2 \times 0.38^2)$	7.1	RJ45 IP67	M12 straight	0.072	0.041
 Picture obtainable. //	$(2 \times 2 \times 0.20^2 + 1 \times 2 \times 0.38^2)$	7.1	0.5 Speedtec	RJ45 IP20	0.072	0.041
 Picture obtainable. //	$(2 \times 2 \times 0.20^2 + 1 \times 2 \times 0.38^2)$	7.1	0.5 ÜWM	RJ45 IP67	0.072	0.041
 Picture obtainable. //	$(2 \times 2 \times 0.20^2 + 1 \times 2 \times 0.38^2)$	7.1	0.5 ÜWM	RJ45 IP20	0.072	0.041

Additional types upon request.

Varying parameters possible.
ÜWM = coupling nut with full thread

More information:
traxline.de

tsubaki-kabelschlepp.com

Technical support:
technik@kabelschlepp.de

Power cables assembled to BOSCH REXROTH

Shielded continuous bending hi-flex cables

Properties of the cables:

- UV-resistant
- CFC-free
- Minimum bend radius
7.5 x Ø
- Halogen-free
- Flame-retardant
- Approvals:
cURus,
based on VDE,
REACH/RoHS II

Definition
from page 164

Power basic cables assembled to BOSCH REXROTH

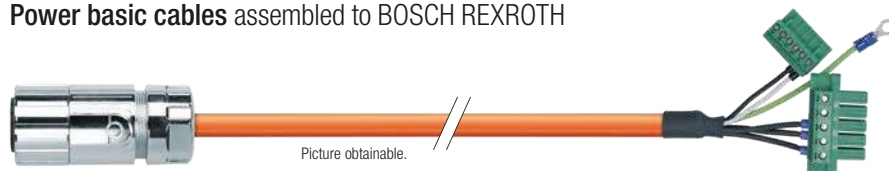
Technical Information
from page 178

Bosch Rexroth Assembling	Core number x Cross-section [mm ²]	max. Ø [mm]	Connection Motor	Connection Controller	Cable weight [kg/m]	Copper weight [kg/m]
IKG4008	(4 G 1 ² + 2 x (2 x 0.75 ²))	11.3	1 ÜWM	AEH	0.194	0.136
RKL0005	(4 G 1 ² + 2 x (2 x 0.75 ²))	11.3	1 ÜWM	RLS	0.194	0.136
RKL0014	(4 G 1 ² + 2 x (2 x 0.75 ²))	11.3	1 ÜWM	RLS	0.194	0.136
RKL0015	(4 G 1.5 ² + 2 x (2 x 0.75 ²))	12.5	1 ÜWM	RLS	0.234	0.170
RKL0016	(4 G 1.5 ² + 2 x (2 x 0.75 ²))	12.5	1.5 ÜWM	RLS	0.234	0.170
RKL0017	(4 G 1.5 ² + 2 x (2 x 0.75 ²))	12.5	1.5 ÜWM	RLS	0.234	0.170
RKL0018	(4 G 2.5 ² + 2 x (2 x 1 ²))	14.3	1.5 ÜWM	RLS	0.327	0.229
RKL0019	(4 G 1 ² + 2 x (2 x 0.75 ²))	11.3	1 ÜWM	RLS	0.194	0.136
RKL0046	(4 G 2.5 ² +2x(2x1 ²))	14.3	1 ÜWM	RLS	0.327	0.229
RKL0049	(4 G 6 ² + (2 x 1 ²) + (2 x 1.5 ²))	17.9	1.5 ÜWM	RLS	0.552	0.445
RKL0050	(4 G 1.5 ² + 2 x (2 x 0.75 ²))	12.5	1.5 ÜWM	RLS	0.234	0.170
RKL0052	(4 G 2.5 ² + 2 x (2 x 1 ²))	14.3	1.5 ÜWM	RLS	0.327	0.229
RKL0053	(4 G 1 ² + 2 x (2 x 0.75 ²))	11.3	1 ÜWM	RLS	0.194	0.136
RKL0057	(4 G 2.5 ² + 2 x (2 x 1 ²))	14.3	1 ÜWM	RLS	0.327	0.229
RKL0058	(4 G 4 ² + (2 x 1 ²) + (2 x 1.5 ²))	16.1	1.5 ÜWM	RLS	0.435	0.328
RKL4300	(4 G 1.5 ² + 2 x (2 x 0.75 ²))	12.5	1 ÜWM	RLS	0.234	0.170
RKL4301	(4 G 1.5 ² + 2 x (2 x 0.75 ²))	12.5	1 ÜWM	RLS	0.234	0.170
RKL4302	(4 G 1 ² + 2 x (2 x 0.75 ²))	11.3	1 ÜWM	RLS	0.194	0.136
RKL4303	(4 G 1 ² + 2 x (2 x 0.75 ²))	11.3	1 ÜWM	RLS	0.194	0.136

Additional types upon request.

Varying parameters possible.
ÜWM = coupling nut with full thread
RLS = Connector package

Technical support:
Fon: +49 (0)2762 4003-0

Assembled cables | Type selection

Power basic cables assembled to BOSCH REXROTH

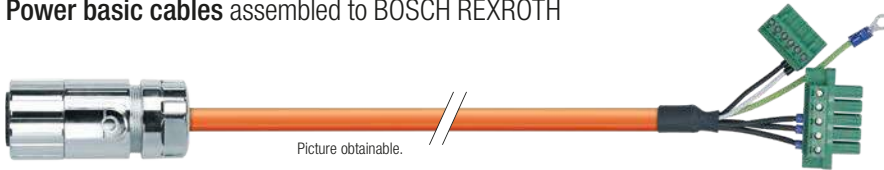

Picture obtainable.

Bosch Rexroth Assembling	Core number x Cross-section [mm ²]	max. Ø [mm]	Connection Motor	Connection Controller	Cable weight [kg/m]	Copper weight [kg/m]
RKL4306	(4 G 1.5 ² + 2 x (2 x 0.75 ²))	12.5	1.5 ÜWM	RLS	0.234	0.170
RKL4307	(4 G 1.5 ² + 2 x (2 x 0.75 ²))	12.5	1.5 ÜWM	RLS	0.234	0.170
RKL4308	(4 G 2.5 ² + 2 x (2 x 1 ²))	14.3	1.5 ÜWM	RLS	0.327	0.229
RKL4309	(4 G 2.5 ² + 2 x (2 x 1 ²))	14.3	1.5 ÜWM	RLS	0.327	0.229
RKL4310	(4 G 2.5 ² + 2 x (2 x 1 ²))	14.3	1.5 ÜWM	RLS	0.327	0.229
RKL4313	(4 G 4 ² + (2 x 1 ²) + (2 x 1.5 ²))	16.1	1.5 ÜWM	RLS	0.435	0.328
RKL4314	(4 G 4 ² + (2 x 1 ²) + (2 x 1.5 ²))	16.1	1.5 ÜWM	RLS	0.435	0.328
RKL4315	(4 G 4 ² + (2 x 1 ²) + (2 x 1.5 ²))	16.1	1.5 ÜWM	RLS	0.435	0.328
RKL4317	(4 G 6 ² + (2 x 1 ²) + (2 x 1.5 ²))	17.9	1.5 ÜWM	RLS	0.552	0.445
RKL4318	(4 G 6 ² + (2 x 1 ²) + (2 x 1.5 ²))	17.9	1.5 ÜWM	RLS	0.552	0.445
RKL4345	(4 G 2.5 ² + 2 x (2 x 1 ²))	14.3	1 ÜWM	RLS	0.327	0.229
RKL4346	(4 G 2.5 ² + 2 x (2 x 1 ²))	14.3	1 ÜWM	RLS	0.327	0.229

Additional types upon request.

Varying parameters possible.
 ÜWM = coupling nut with full thread
 RLS = Connector package

Assembled cables | Type selection

Power extension cables assembled to BOSCH REXROTH

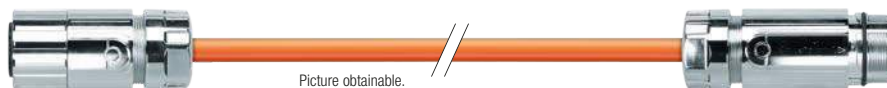
Definition
from page 164Technical Information
from page 178

Bosch Rexroth Assembling	Core number x Cross-section [mm ²]	max. Ø [mm]	Connection Motor	Connection Controller	Cable weight [kg/m]	Copper weight [kg/m]
IKG4006	(4 G 1 ² + 2 x (2 x 0.75 ²))	11.3	1 ÜWM	1 ÜWM	0.194	0.136
IKG4027	(4 G 1.5 ² + 2 x (2 x 0.75 ²))	12.5	1 ÜWM	1 ÜWM	0.234	0.170
IKG4074	(4 G 2.5 ² + 2 x (2 x 1 ²))	14.3	1 ÜWM	1 ÜWM	0.327	0.229
RKL0006	(4 G 1 ² + 2 x (2 x 0.75 ²))	11.3	1 ÜWM	1 ÜWM	0.194	0.136
RKL4304	(4 G 1.5 ² + 2 x (2 x 0.75 ²))	12.5	1 ÜWM	1 ÜWM	0.234	0.170
RKL4305	(4 G 1 ² + 2 x (2 x 0.75 ²))	11.3	1 ÜWM	1 ÜWM	0.194	0.136
RKL4347	(4 G 2.5 ² + 2 x (2 x 1 ²))	14.3	1 ÜWM	1 ÜWM	0.327	0.229
RKL4311	(4 G 1.5 ² + 2 x (2 x 0.75 ²))	12.5	1.5 ÜWM	1.5 ÜWM	0.234	0.170
RKL4312	(4 G 2.5 ² + 2 x (2 x 1 ²))	14.3	1.5 ÜWM	1.5 ÜWM	0.327	0.229
RKL4316	(4 G 4 ² + (2 x 1 ²) + (2 x 1.5 ²))	16.1	1.5 ÜWM	1.5 ÜWM	0.435	0.328
RKL4319	(4 G 6 ² + (2 x 1 ²) + (2 x 1.5 ²))	17.9	1.5 ÜWM	1.5 ÜWM	0.552	0.445

Additional types upon request.

Varying parameters possible.

ÜWM = coupling nut with full thread

Technical support:
Fon: +49 (0)2762 4003-0

Signal cables assembled to BOSCH REXROTH

Shielded continuous bending hi-flex cables

Properties of the cables:

- UV-resistant
- Halogen-free
- Approvals: cURus, based on VDE, REACH/RoHS II
- CFC-free
- Flame-retardant
- Minimum bend radius 7.5 x Ø to 10 x Ø



More information:
traxline.de

Signal basic cables assembled to BOSCH REXROTH

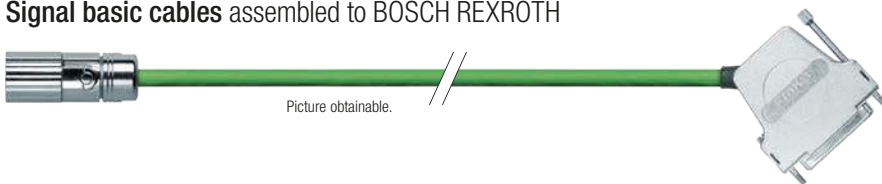

Bosch Rexroth Assembling	Core number x Cross-section [mm ²]	max. Ø [mm]	Connection Motor	Connection Controller	Cable weight [kg/m]	Copper weight [kg/m]
IKS4001	(4 x 2 x 0.14 ² + 4 x 1 ² + (4 x 0.14 ²))	10.2	1 ÜWM	D-SUB	0.142	0.080
IKS4002	(3 x (2 x 0.25 ²) + 3 x 0.25 ² + 2 x 1 ²)	9.3	1 ÜWM	D-SUB	0.130	0.084
IKS4005	(4 x 2 x 0.25 ² + 2 x 1 ²)	9.1	1 ÜWM	D-SUB	0.118	0.064
IKS4038	(4 x 2 x 0.14 ² + 4 x 1 ² + (4 x 0.14 ²))	10.2	1 ÜWM	D-SUB	0.142	0.080
RKG0004	(4 x 2 x 0.14 ² + 4 x 1 ² + (4 x 0.14 ²))	10.2	1 ÜWM	D-SUB	0.142	0.080
RKG0011	(4 x 2 x 0.14 ² + 4 x 1 ² + (4 x 0.14 ²))	10.2	1 ÜWM	D-SUB	0.142	0.080
RKG0013	(3 x (2 x 0.25 ²) + 3 x 0.25 ² + 2 x 1 ²)	9.3	1 ÜWM	D-SUB	0.130	0.084
RKG0014	(3 x (2 x 0.25 ²) + 3 x 0.25 ² + 2 x 1 ²)	9.3	1 ÜWM	D-SUB	0.130	0.084
RKG0026	(3 x (2 x 0.25 ²) + 3 x 0.25 ² + 2 x 1 ²)	9.3	1 ÜWM	D-SUB	0.130	0.084
RKG0036	(4 x 2 x 0.14 ² + 4 x 1 ² + (4 x 0.14 ²))	10.2	1 ÜWM	D-SUB	0.142	0.080
RKG4200	(4 x 2 x 0.25 ² + 2 x 0.5 ²)	8.8	1 ÜWM	D-SUB	0.103	0.051

Additional types upon request.

Varying parameters possible.
ÜWM = coupling nut with full thread

tsubaki-kabelschlepp.com

Technical support:
technik@kabelschlepp.de

Assembled cables | Type selection

Signal basic cables assembled to BOSCH REXROTH

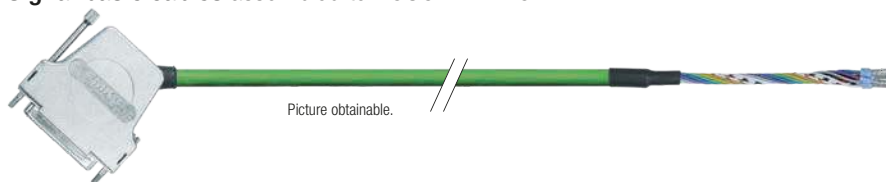

Picture obtainable.

Definition
from page 164

Bosch Rexroth Assembling	Core number x Cross-section [mm ²]	max. Ø [mm]	Connection Motor	Connection Controller	Cable weight [kg/m]	Copper weight [kg/m]
IKS4099	$(3 \times (2 \times 0.25^2) + 3 \times 0.25^2 + 2 \times 1^2)$	9.3	D-SUB	AEH	0.130	0.084
IKS4182	$(4 \times 2 \times 0.25^2 + 2 \times 1^2)$	9.1	D-SUB	AEH	0.118	0.064
RKG0025	$(3 \times (2 \times 0.25^2) + 3 \times 0.25^2 + 2 \times 1^2)$	9.3	D-SUB	AEH	0.130	0.084
RKG0029	$(4 \times 2 \times 0.25^2 + 2 \times 0.5^2)$	8.8	D-SUB	AEH	0.103	0.051
RKG0030	$(3 \times (2 \times 0.25^2) + 3 \times 0.25^2 + 2 \times 1^2)$	9.3	D-SUB	AEH	0.130	0.084

Additional types upon request.

Varying parameters possible.

AEH = end sleeve

Technical Information
from page 178

Signal extension cables assembled to BOSCH REXROTH



Picture obtainable.

Technical support:

Fon: +49 (0)2762 4003-0

Bosch Rexroth Assembling	Core number x Cross-section [mm ²]	max. Ø [mm]	Connection Motor	Connection Controller	Cable weight [kg/m]	Copper weight [kg/m]
IKS4011	$(4 \times 2 \times 0.25^2 + 2 \times 1^2)$	9.1	1 ÜWM	1 ÜWM	0.118	0.064
IKS4012	$(4 \times 2 \times 0.14^2 + 4 \times 1^2 + (4 \times 0.14^2))$	10.2	1 ÜWM	1 ÜWM	0.142	0.080
RKG0038	$(4 \times 2 \times 0.14^2 + 4 \times 1^2 + (4 \times 0.14^2))$	10.2	1 ÜWM	1 ÜWM	0.142	0.080
RKG4201	$(4 \times 2 \times 0.25^2 + 2 \times 0.5^2)$	8.8	1 ÜWM	1 ÜWM	0.103	0.051

Additional types upon request.

Varying parameters possible.

ÜWM = coupling nut with full thread

Power cables assembled to LENZE

Shielded continuous bending hi-flex cables

Properties of the cables:

- UV-resistant
- Halogen-free
- Approvals: cURus, based on VDE, REACH/RoHS II
- CFC-free
- Flame-retardant
- Minimum bend radius 7.5 x \varnothing



More information:
traxline.de

Power basic cables assembled to LENZE



LENZE Assembling	Core number x Cross-section [mm ²]	max. \varnothing [mm]	Connection Motor	Connection Controller	Cable weight [kg/m]	Copper weight [kg/m]
EYL0002AXXXXL01A00	5 G 1 ²	8.2	1 ÜWM	open end	0.097	0.048
EYL0002AXXXXL03A00	5 G 1 ²	8.2	1 Speedtec	open end	0.097	0.048
EYP0010AXXXXM01A00	(4 G 1 ² + (2 x 0.5 ²))	11.1	1 ÜWM	open end	0.166	0.090
EYP0010AXXXXM04A00	(4 G 1 ² + (2 x 0.5 ²))	11.1	1 Speedtec	open end	0.166	0.090
EYP0011AXXXXM01A00	(4 G 1.5 ² + (2 x 0.5 ²))	12.1	1 ÜWM	open end	0.206	0.110
EYP0011AXXXXM04A00	(4 G 1.5 ² + (2 x 0.5 ²))	12.1	1 Speedtec	open end	0.206	0.110
EYP0012AXXXXM01A00	(4 G 2.5 ² + (2 x 0.5 ²))	13.8	1 ÜWM	open end	0.268	0.150
EYP0012AXXXXM02A00	(4 G 2.5 ² + (2 x 0.5 ²))	13.8	1.5 ÜWM	open end	0.268	0.150
EYP0012AXXXXM04A00	(4 G 2.5 ² + (2 x 0.5 ²))	13.8	1 Speedtec	open end	0.268	0.150
EYP0012AXXXXM05A00	(4 G 2.5 ² + (2 x 0.5 ²))	13.8	1.5 Speedtec	open end	0.268	0.150
EYP0015AXXXXM03A00	4 G 10 + (2 x 1.0) C	20.1	1.5 ÜWM	open end	0.706	0.508
EYP0015AXXXXM06A00	4 G 10 + (2 x 1.0) C	20.1	1.5 Speedtec	open end	0.706	0.508
EYP0016AXXXXM03A00	4 G 16 + (2 x 1.0) C	23.8	1.5 ÜWM	open end	1.008	0.802
EYP0016AXXXXM06A00	4 G 16 + (2 x 1.0) C	23.8	1.5 Speedtec	open end	1.008	0.802
EYP0053AXXXXM02A00	(4 G 4 ² + (2 x 1 ²) + 2 x AW G 22)	16.5	1.5 ÜWM	open end	0.420	0.280
EYP0053AXXXXM05A00	(4 G 4 ² + (2 x 1 ²) + 2 x AW G 22)	16.5	1.5 Speedtec	open end	0.420	0.280
EYP0054AXXXXM03A00	(4 G 6 ² + (2 x 1 ²) + 2 x AW G 22)	18.8	1.5 ÜWM	open end	0.540	0.360
EYP0054AXXXXM06A00	(4 G 6 ² + (2 x 1 ²) + 2 x AW G 22)	18.8	1.5 Speedtec	open end	0.540	0.360

Additional types upon request.

Varying parameters possible.
ÜWM = coupling nut with full thread

tsubaki-kabelschlepp.com

Technical support:
technik@kabelschlepp.de

Assembled cables

Assembled cables | Type selection

Power basic cables assembled to LENZE

Definition
from page 164

LENZE Assembling	Core number x Cross-section [mm ²]	max. Ø [mm]	Connection Motor	Connection Controller	Cable weight [kg/m]	Copper weight [kg/m]
EYP0010VXXXXA00P01	(4 G 1 ² + (2 x 0.5 ²))	11.1	open end	1 ÜWM	0.166	0.090
EYP0010VXXXXA00P04	(4 G 1 ² + (2 x 0.5 ²))	11.1	open end	1 Speedtec	0.166	0.09
EYP0011VXXXXA00P01	(4 G 1.5 ² + (2 x 0.5 ²))	12.1	open end	1 ÜWM	0.206	0.11
EYP0011VXXXXA00P04	(4 G 1.5 ² + (2 x 0.5 ²))	12.1	open end	1 Speedtec	0.206	0.11
EYP0012VXXXXA00P01	(4 G 2.5 ² + (2 x 0.5 ²))	13.8	open end	1 ÜWM	0.268	0.15
EYP0012VXXXXA00P02	(4 G 2.5 ² + (2 x 0.5 ²))	13.8	open end	1.5 ÜWM	0.268	0.15
EYP0012VXXXXA00P04	(4 G 2.5 ² + (2 x 0.5 ²))	13.8	open end	1 Speedtec	0.268	0.15
EYP0012VXXXXA00P05	(4 G 2.5 ² + (2 x 0.5 ²))	13.8	open end	1.5 Speedtec	0.268	0.15
EYP0015VXXXXA00P03	4 G 10 + (2 x 1.0) C	20.1	open end	1.5 ÜWM	0.706	0.508
EYP0015VXXXXA00P06	4 G 10 + (2 x 1.0) C	20.1	open end	1.5 Speedtec	0.706	0.508
EYP0016VXXXXA00P03	4 G 16 + (2 x 1.0) C	23.8	open end	1.5 ÜWM	1.008	0.802
EYP0016VXXXXA00P06	4 G 16 + (2 x 1.0) C	23.8	open end	1.5 Speedtec	1.008	0.802
EYP0053VXXXXA00P02	(4 G 4 ² + (2 x 1 ²) + 2 x AW G 22)	16.5	open end	1.5 ÜWM	0.42	0.28
EYP0053VXXXXA00P05	(4 G 4 ² + (2 x 1 ²) + 2 x AW G 22)	16.5	open end	1.5 Speedtec	0.42	0.28
EYP0054VXXXXA00P03	(4 G 6 ² + (2 x 1 ²) + 2 x AW G 22)	18.8	open end	1.5 ÜWM	0.54	0.36
EYP0054VXXXXA00P06	(4 G 6 ² + (2 x 1 ²) + 2 x AW G 22)	18.8	open end	1.5 Speedtec	0.54	0.36

Technical Information
from page 178Technical support:
Fon: +49 (0)2762 4003-0

Additional types upon request.

Varying parameters possible.

ÜWM = coupling nut with full thread

Assembled cables | Type selection

Power extension cables assembled to LENZE

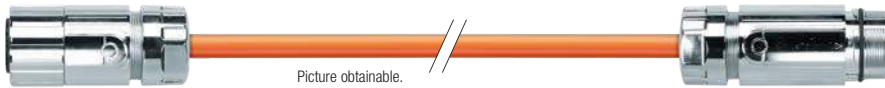

LENZE Assembling	Core number x Cross-section [mm ²]	max. Ø [mm]	Connection Motor	Connection Controller	Cable weight [kg/m]	Copper weight [kg/m]
EYP0010VXXXXM01P01	(4 G 1 ² + (2 x 0.5 ²))	11.1	1 ÜWM	1 ÜWM	0.166	0.090
EYP0010VXXXXM01P04	(4 G 1 ² + (2 x 0.5 ²))	11.1	1 ÜWM	1 Speedtec	0.166	0.090
EYP0010VXXXXM04P01	(4 G 1 ² + (2 x 0.5 ²))	11.1	1 Speedtec	1 ÜWM	0.166	0.090
EYP0010VXXXXM04P04	(4 G 1 ² + (2 x 0.5 ²))	11.1	1 Speedtec	1 Speedtec	0.166	0.090
EYP0011VXXXXM01P01	(4 G 1.5 ² + (2 x 0.5 ²))	12.1	1 ÜWM	1 ÜWM	0.206	0.110
EYP0011VXXXXM01P04	(4 G 1.5 ² + (2 x 0.5 ²))	12.1	1 ÜWM	1 Speedtec	0.206	0.110
EYP0011VXXXXM04P01	(4 G 1.5 ² + (2 x 0.5 ²))	12.1	1 Speedtec	1 ÜWM	0.206	0.110
EYP0011VXXXXM04P04	(4 G 1.5 ² + (2 x 0.5 ²))	12.1	1 Speedtec	1 Speedtec	0.206	0.110
EYP0012VXXXXM01P01	(4 G 2.5 ² + (2 x 0.5 ²))	13.8	1 ÜWM	1 ÜWM	0.268	0.150
EYP0012VXXXXM01P04	(4 G 2.5 ² + (2 x 0.5 ²))	13.8	1 ÜWM	1 Speedtec	0.268	0.150
EYP0012VXXXXM02P02	(4 G 2.5 ² + (2 x 0.5 ²))	13.8	1.5 ÜWM	1.5 ÜWM	0.268	0.150
EYP0012VXXXXM02P05	(4 G 2.5 ² + (2 x 0.5 ²))	13.8	1.5 ÜWM	1.5 Speedtec	0.268	0.150
EYP0012VXXXXM04P01	(4 G 2.5 ² + (2 x 0.5 ²))	13.8	1 Speedtec	1 ÜWM	0.268	0.150
EYP0012VXXXXM04P04	(4 G 2.5 ² + (2 x 0.5 ²))	13.8	1 Speedtec	1 Speedtec	0.268	0.150
EYP0012VXXXXM05P02	(4 G 2.5 ² + (2 x 0.5 ²))	13.8	1.5 Speedtec	1.5 ÜWM	0.268	0.150
EYP0012VXXXXM05P05	(4 G 2.5 ² + (2 x 0.5 ²))	13.8	1.5 Speedtec	1.5 Speedtec	0.268	0.150
EYP0015VXXXXM03P03	4 G 10 + (2 x 1.0) C	20.1	1.5 ÜWM	1.5 ÜWM	0.706	0.508
EYP0015VXXXXM03P06	4 G 10 + (2 x 1.0) C	20.1	1.5 ÜWM	1.5 Speedtec	0.706	0.508
EYP0015VXXXXM06P03	4 G 10 + (2 x 1.0) C	20.1	1.5 Speedtec	1.5 ÜWM	0.706	0.508
EYP0015VXXXXM06P06	4 G 10 + (2 x 1.0) C	20.1	1.5 Speedtec	1.5 Speedtec	0.706	0.508
EYP0016VXXXXM03P03	4 G 16 + (2 x 1.0) C	23.8	1.5 ÜWM	1.5 ÜWM	1.008	0.802
EYP0016VXXXXM03P06	4 G 16 + (2 x 1.0) C	23.8	1.5 ÜWM	1.5 Speedtec	1.008	0.802
EYP0016VXXXXM06P03	4 G 16 + (2 x 1.0) C	23.8	1.5 Speedtec	1.5 ÜWM	1.008	0.802
EYP0016VXXXXM06P06	4 G 16 + (2 x 1.0) C	23.8	1.5 Speedtec	1.5 Speedtec	1.008	0.802
EYP0053VXXXXM02P02	(4 G 4 ² + (2 x 1 ²) + 2 x AW G 22)	16.5	1.5 ÜWM	1.5 ÜWM	0.42	0.280
EYP0053VXXXXM02P05	(4 G 4 ² + (2 x 1 ²) + 2 x AW G 22)	16.5	1.5 ÜWM	1.5 Speedtec	0.42	0.280
EYP0053VXXXXM05P02	(4 G 4 ² + (2 x 1 ²) + 2 x AW G 22)	16.5	1.5 Speedtec	1.5 ÜWM	0.42	0.280
EYP0053VXXXXM05P05	(4 G 4 ² + (2 x 1 ²) + 2 x AW G 22)	16.5	1.5 Speedtec	1.5 Speedtec	0.42	0.280
EYP0054VXXXXM03P03	(4 G 6 ² + (2 x 1 ²) + 2 x AW G 22)	18.8	1.5 ÜWM	1.5 ÜWM	0.54	0.360
EYP0054VXXXXM03P06	(4 G 6 ² + (2 x 1 ²) + 2 x AW G 22)	18.8	1.5 ÜWM	1.5 Speedtec	0.54	0.360
EYP0054VXXXXM06P03	(4 G 6 ² + (2 x 1 ²) + 2 x AW G 22)	18.8	1.5 Speedtec	1.5 ÜWM	0.54	0.360
EYP0054VXXXXM06P06	(4 G 6 ² + (2 x 1 ²) + 2 x AW G 22)	18.8	1.5 Speedtec	1.5 Speedtec	0.54	0.360

Additional types upon request.

Varying parameters possible.

ÜWM = coupling nut with full thread

Signal cables assembled to LENZE

Shielded continuous bending hi-flex cables

Definition
from page 164

Properties of the cables:

- UV-resistant
- CFC-free
- Minimum bend radius
7.5 x Ø to 10 x Ø
- Halogen-free
- Flame-retardant
- Approvals:
cURus,
based on VDE,
REACH/RoHS II

Technical Information
from page 178

Signal basic cables assembled to LENZE

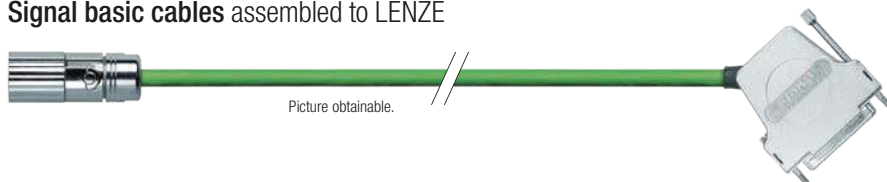

LENZE Assembling	Core number x Cross-section [mm ²]	max. Ø [mm]	Connection Motor	Connection Controller	Cable weight [kg/m]	Copper weight [kg/m]
EYF0020AXXXXF01S01	3 x (2 x 0.14 ²) + (3 x 0.14 ²)	10.9	1 ÜWM	D-SUB	0.127	0.040
EYF0020AXXXXF01S02	3 x (2 x 0.14 ²) + (3 x 0.14 ²)	10.9	1 ÜWM	D-SUB	0.127	0.040
EYF0020AXXXXF05S01	3 x (2 x 0.14 ²) + (3 x 0.14 ²)	10.9	1 Speedtec	D-SUB	0.127	0.040
EYF0020AXXXXF05S02	3 x (2 x 0.14 ²) + (3 x 0.14 ²)	10.9	1 Speedtec	D-SUB	0.127	0.040

Additional types upon request.

Varying parameters possible.
ÜWM = coupling nut with full thread

Technical support:
Fon: +49 (0)2762 4003-0

Signal extension cables assembled to LENZE

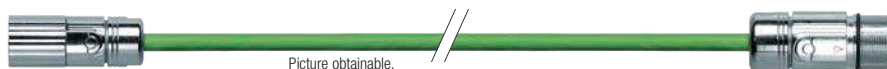

LENZE Assembling	Core number x Cross-section [mm ²]	max. Ø [mm]	Connection Motor	Connection Controller	Cable weight [kg/m]	Copper weight [kg/m]
EYF0020VXXXXF01G01	3 x (2 x 0.14 ²) + (3 x 0.14 ²)	10.9	1 ÜWM	1 ÜWM	0.127	0.040
EYF0020VXXXXF01G06	3 x (2 x 0.14 ²) + (3 x 0.14 ²)	10.9	1 ÜWM	1 Speedtec	0.127	0.040
EYF0020VXXXXF05G06	3 x (2 x 0.14 ²) + (3 x 0.14 ²)	10.9	1 Speedtec	1 Speedtec	0.127	0.040

Additional types upon request.

Varying parameters possible.
ÜWM = coupling nut with full thread

Power cables assembled to SEW

Shielded continuous bending hi-flex cables

Properties of the cables:

- UV-resistant
- CFC-free
- Minimum bend radius
7.5 x Ø
- Halogen-free
- Flame-retardant
- Approvals:
cURus,
based on VDE,
REACH/RoHS II



Power basic cables assembled to SEW



SEW Assembling	Core number x Cross-section [mm ²]	max. Ø [mm]	Connection Motor	Connection Controller	Cable weight [kg/m]	Copper weight [kg/m]
0590 4803	(4 G 4 ²)	12,3	1 ÜWM	open end	0,273	0,195
0590 6245	(4 G 1,5 ²)	9,5	1 ÜWM	open end	0,136	0,080
0590 6253	(4 G 2,5 ²)	11,0	1 ÜWM	open end	0,198	0,120
1335 0293	(4 G 6 ²)	14,9	1,5 ÜWM	open end	0,393	0,296
1335 0307	(4 G 10 ²)	18,2	1,5 ÜWM	open end	0,616	0,445
1335 0315	(4 G 16 ²)	22,3	1,5 ÜWM	open end	0,949	0,730

Additional types upon request.

Varying parameters possible.
ÜWM = coupling nut with full thread

Assembled cables | Type selection

Power basic cables assembled to SEW

Definition
from page 164Technical Information
from page 178Technical support:
Fon: +49 (0)2762 4003-0

SEW Assembling	Core number x Cross-section [mm ²]	max. Ø [mm]	Connection Motor	Connection Controller	Cable weight [kg/m]	Copper weight [kg/m]
0590 4846	4 G 4 + (3 x 1.0) C	15.3	1 ÜWM	open end	0.417	0.262
0590 6318	4 G 1.5 + (3 x 1.0) C	12.3	1 ÜWM	open end	0.247	0.137
0590 6326	4 G 2.5 + (3 x 1.0) C	13.4	1 ÜWM	open end	0.318	0.190
1332 2139	(4 G 2.5 ² + (2 x 1 ²))	13.1	1 ÜWM	open end	0.274	0.180
1332 2147	(4 G 4 ² + (2 x 1 ²))	14.9	1 ÜWM	open end	0.378	0.260
1332 4853	(4 G 1.5 ² + (2 x 1 ²))	11.7	1 ÜWM	open end	0.212	0.140
1333 1221	(4 G 1.5 ² + (2 x 1 ²))	11.7	1 ÜWM	open end	0.212	0.140
1333 2155	(4 G 2.5 ² + (2 x 1 ²))	13.1	1 ÜWM	open end	0.274	0.180
1333 2163	(4 G 4 ² + (2 x 1 ²))	14.9	1 ÜWM	open end	0.378	0.260
1335 0153	4 G 6 + (3 x 1.5) C	17.5	1.5 ÜWM	open end	0.579	0.362
1335 0234	4 G 6 + (3 x 1.5) C	17.5	1.5 ÜWM	open end	0.579	0.362
1335 4302	4 G 1.5 + (3 x 1.0) C	12.3	1 ÜWM	open end	0.247	0.137
1335 4329	4 G 4 + (3 x 1.0) C	15.3	1 ÜWM	open end	0.417	0.262
1335 4388	4 G 1.5 + (3 x 1.0) C	12.3	1 ÜWM	open end	0.247	0.137
1335 4396	4 G 2.5 + (3 x 1.0) C	13.4	1 ÜWM	open end	0.318	0.190
1342 1603	4 G 4 + (3 x 1.0) C	15.3	1 ÜWM	open end	0.417	0.262

Additional types upon request.

Varying parameters possible.

ÜWM = coupling nut with full thread

Assembled cables | Type selection

Power basic cables assembled to SEW



SEW Assembling	Core number x Cross-section [mm ²]	max. Ø [mm]	Connection Motor	Connection Controller	Cable weight [kg/m]	Copper weight [kg/m]
0199 1809	(4 G 1.5 ²)	9.5	C148	open end	0.136	0.080
0199 1825	(4 G 2.5 ²)	11	C148	open end	0.198	0.120
0199 1841	(4 G 4 ²)	12.3	C148	open end	0.273	0.195
0199 1868	(4 G 6 ²)	14.9	C148	open end	0.393	0.296
0199 1884	(4 G 10 ²)	18.2	C148	open end	0.616	0.445
1333 1140	(4 G 1.5 ²)	9.5	C148	open end	0.136	0.080
1333 1159	(4 G 2.5 ²)	11	C148	open end	0.198	0.120

Additional types upon request.

Varying parameters possible.

Power basic cables assembled to SEW



SEW Assembling	Core number x Cross-section [mm ²]	max. Ø [mm]	Connection Motor	Connection Controller	Cable weight [kg/m]	Copper weight [kg/m]
0199 1949	4 G 4 + (3 x 1.0) C	15.3	C148	open end	0.417	0.262
0199 1965	4 G 6 + (3 x 1.5) C	17.5	C148	open end	0.579	0.362
1333 1167	4 G 1.5 + (3 x 1.0) C	12.3	C148	open end	0.247	0.137
1333 1175	4 G 2.5 + (3 x 1.0) C	13.4	C148	open end	0.318	0.190

Additional types upon request.

Varying parameters possible.

More information:
traxline.de

tsubaki-kabelschlepp.com

Technical support:
technik@kabelschlepp.de

Assembled cables | Type selection

Power extension cables assembled to SEW

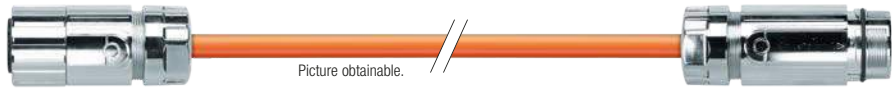
Definition
from page 164

SEW Assembling	Core number x Cross-section [mm ²]	max. Ø [mm]	Connection Motor	Connection Controller	Cable weight [kg/m]	Copper weight [kg/m]
1333 2457	(4 G 1.5 ²)	9.5	1 ÜWM	1 ÜWM	0.136	0.080
1333 2465	(4 G 2.5 ²)	11	1 ÜWM	1 ÜWM	0.198	0.120
1333 2473	(4 G 4 ²)	12.3	1 ÜWM	1 ÜWM	0.273	0.195
1333 2481	4 G 1.5 + (3 x 1.0) C	12.3	1 ÜWM	1 ÜWM	0.247	0.137
1335 0021	(4 G 6 ²)	14.9	1.5 ÜWM	1.5 ÜWM	0.393	0.296
1335 0048	(4 G 10 ²)	18.2	1.5 ÜWM	1.5 ÜWM	0.616	0.445
1335 0056	(4 G 16 ²)	22.3	1.5 ÜWM	1.5 ÜWM	0.949	0.730
1335 0099	4 G 6 + (3 x 1.5) C	17.5	1.5 ÜWM	1.5 ÜWM	0.579	0.362
1335 4221	4 G 1.5 + (3 x 1.0) C	12.3	1 ÜWM	1 ÜWM	0.247	0.137
1335 4248	4 G 2.5 + (3 x 1.0) C	13.4	1 ÜWM	1 ÜWM	0.318	0.190
1335 4337	4 G 4 + (3 x 1.0) C	15.3	1 ÜWM	1 ÜWM	0.417	0.262

Technical Information
from page 178

Additional types upon request.

Varying parameters possible.

ÜWM = coupling nut with full thread

Technical support:
Fon: +49 (0)2762 4003-0

Assembled cables | Type selection

Power extension cables assembled to SEW

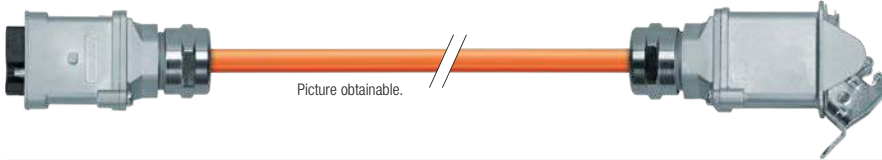

SEW Assembling	Core number x Cross-section [mm ²]	max. Ø [mm]	Connection Motor	Connection Controller	Cable weight [kg/m]	Copper weight [kg/m]
0199 2007	4 G 1.5 + (3 x 1.0) C	12.3	C148	C148	0.247	0.137
0199 204X	4 G 4 + (3 x 1.0) C	15.3	C148	C148	0.417	0.262
0199 2066	4 G 6 + (3 x 1.5) C	17.5	C148	C148	0.579	0.362
0199 5545	(4 G 4 ²)	12.3	C148	C148	0.273	0.195
0199 5561	(4 G 6 ²)	14.9	C148	C148	0.393	0.296
0199 5588	(4 G 10 ²)	18.2	C148	C148	0.616	0.445
1333 1183	(4 G 1.5 ²)	9.5	C148	C148	0.136	0.080
1333 1191	(4 G 2.5 ²)	11	C148	C148	0.198	0.120
1333 1205	4 G 1.5 + (3 x 1.0) C	12.3	C148	C148	0.247	0.137
1333 1213	4 G 2.5 + (3 x 1.0) C	13.4	C148	C148	0.318	0.190

Additional types upon request.

Varying parameters possible.

Signal cables assembled to SEW

Shielded continuous bending hi-flex cables

Definition
from page 164

Properties of the cables:

- UV-resistant
- CFC-free
- Minimum bend radius
7.5 x Ø to 10 x Ø
- Halogen-free
- Flame-retardant
- Approvals:
cURus,
based on VDE,
REACH/RoHS II

Technical Information
from page 178

Signal basic cables assembled to SEW

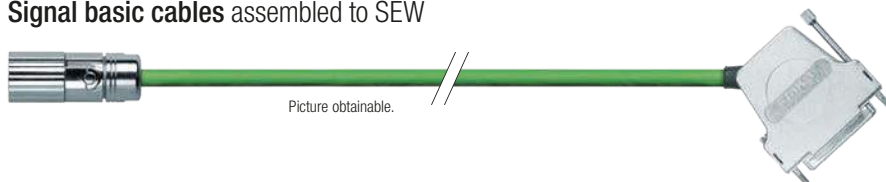

SEW Assembling	Core number x Cross-section [mm ²]	max. Ø [mm]	Connection Motor	Connection Controller	Cable weight [kg/m]	Copper weight [kg/m]
0199 3194	(5 x 2 x 0.25 ²)	9.6	1 ÜWM	D-SUB	0.128	0.055
1332 4551	(6 x 2 x 0.25 ²)	9.9	1 ÜWM	D-SUB	0.147	0.058
1332 7437	(5 x 2 x 0.25 ²)	9.6	1 ÜWM	D-SUB	0.128	0.055
1362 3206	(5 x 2 x 0.25 ²)	9.6	1 ÜWM	D-SUB	0.128	0.055

Additional types upon request.

Varying parameters possible.

ÜWM = coupling nut with full thread

Technical support:
Fon: +49 (0)2762 4003-0

Assembled cables | Type selection

Signal basic cables assembled to SEW

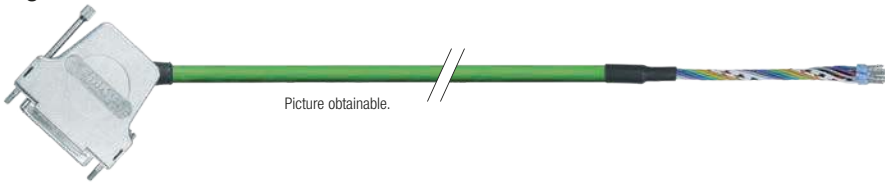

SEW Assembling	Core number x Cross-section [mm ²]	max. Ø [mm]	Connection Motor	Connection Controller	Cable weight [kg/m]	Copper weight [kg/m]
0199 5901	(5 x 2 x 0.25 ²)	9.6	D-SUB	AEH	0.128	0.055
1332 4543	(6 x 2 x 0.25 ²)	9.9	D-SUB	AEH	0.147	0.058
1332 7453	(5 x 2 x 0.25 ²)	9.6	D-SUB	AEH	0.128	0.055
1332 7631	(5 x 2 x 0.25 ²)	9.6	D-SUB	AEH	0.128	0.055
1332 7666	(6 x 2 x 0.25 ²)	9.9	D-SUB	AEH	0.147	0.058
1332 8441	(5 x 2 x 0.25 ²)	9.6	D-SUB	AEH	0.128	0.055
1362 2048	(6 x 2 x 0.25 ²)	9.9	D-SUB	AEH	0.147	0.058

Additional types upon request.

Varying parameters possible.
AEH = end sleeve

More information:
traxline.de

tsubaki-kabelschlepp.com

Signal extension cables assembled to SEW

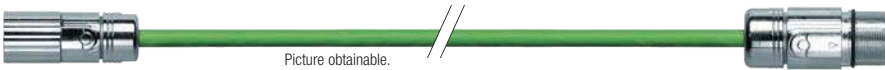

LENZE Assembling	Core number x Cross-section [mm ²]	max. Ø [mm]	Connection Motor	Connection Controller	Cable weight [kg/m]	Copper weight [kg/m]
0199 5405	(6 x 2 x 0.25 ²)	9.9	1 ÜWM	1 ÜWM	0.147	0.058
0199 5413	(5 x 2 x 0.25 ²)	9.6	1 ÜWM	1 ÜWM	0.128	0.055
1333 3879	(6 x 2 x 0.25 ²)	9.9	1 ÜWM	1 ÜWM	0.147	0.058
1362 1971	(6 x 2 x 0.25 ²)	9.9	1 ÜWM	1 ÜWM	0.147	0.058

Additional types upon request.

Varying parameters possible.
ÜWM = coupling nut with full thread

Technical support:
technik@kabelschlepp.de

Assembled cables | Type selection

Other OEM assembled cables

Shielded continuous bending hi-flex PUR cables assembled to OEM

Definition
from page 164

Properties of the cables:

- UV-resistant
- CFC-free
- Minimum bend radius
7.5 x Ø to 10 x Ø
- Halogen-free
- Flame-retardant
- Approvals:
cURus,
based on VDE,
REACH/RoHS II

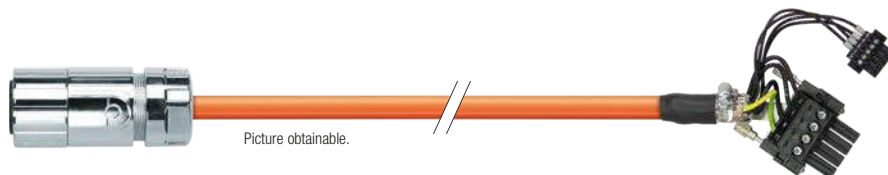
Technical Information
from page 178

Power basic cables and power extension cables assembled to OEM

Manufacturer	Type
B&R	8CM..., 80CM..., 8BCM...
Beckhoff	ZK4500, ZK4501, ZK4502, ZK4701, ZK4800

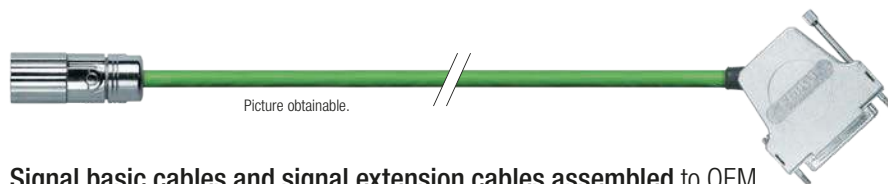
Technical support:
Fon: +49 (0)2762 4003-0

Signal basic cables and signal extension cables assembled to OEM

Manufacturer	Type
B&R	8CE..., 8CR..., 8BCE..., 8BCF..., 8BCR..., 80CM...
Beckhoff	ZK4510, ZK4511, ZK4520, ZK4521, ZK4530, ZK4531

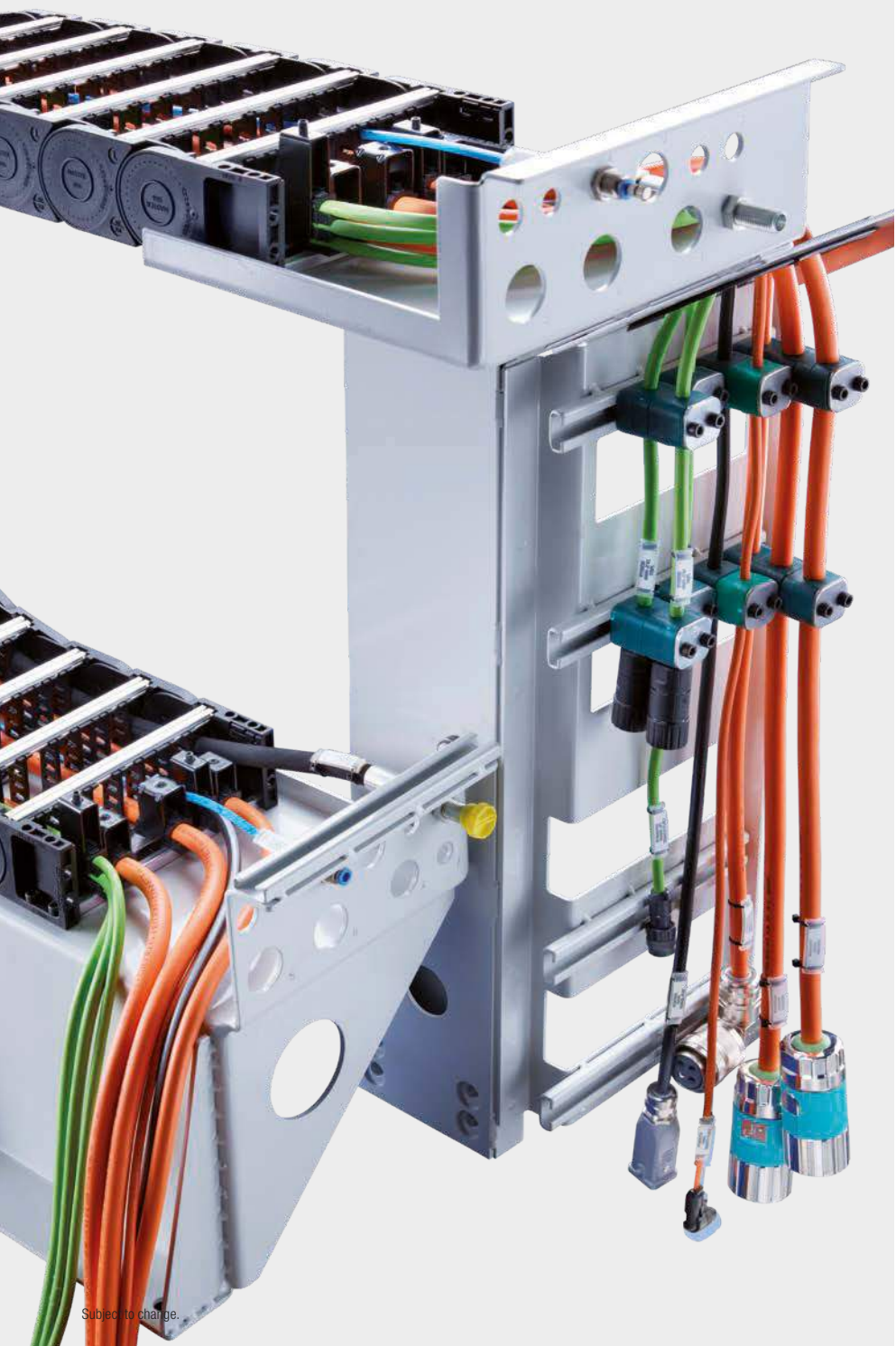

Subject to change.

More information:
traxline.de

tsubaki-kabelschlepp.com

Technical support:
technik@kabelschlepp.de

Assembled
cables

TRAXLINE® USB 2.0 700 CD / USB 3.0 CD assembled

Shielded continuous bending hi-flex USB PUR cable

Definition
from page 164

Properties of the TRAXLINE® cables:

- UV-resistant
- CFC-free
- Minimum bend radius
10 x Ø
- Halogen-free
- Flame-retardant
- Approvals:
cURus,
based on VDE,
REACH/RoHS II

Technical Information
from page 178

USB cable Assembling	Cable	max. Ø [mm]	Connection Motor	Connection Controller	Cable weight [kg/m]	Copper weight [kg/m]
USB 2.0	USB 2.0 S 700 CD	5.2	USB Typee A	open end	0.045	0.030
USB 2.0	USB 2.0 S 700 CD	5.2	USB Type A	USB Type A	0.045	0.030
USB 2.0	USB 2.0 S 700 CD	5.2	USB Type B	open end	0.045	0.030
USB 2.0	USB 2.0 S 700 CD	5.2	USB Type B	USB Type B	0.045	0.030
USB 2.0	USB 2.0 S 700 CD	5.2	USB Type A	USB Type B	0.045	0.030
USB 2.0	USB 2.0 L 700 CD	6.5	USB Type A	open end	0.056	0.040
USB 2.0	USB 2.0 L 700 CD	6.5	USB Type A	USB Type A	0.056	0.040
USB 2.0	USB 2.0 L 700 CD	6.5	USB Type B	open end	0.056	0.040
USB 2.0	USB 2.0 L 700 CD	6.5	USB Type B	USB Type B	0.056	0.040
USB 2.0	USB 2.0 L 700 CD	6.5	USB Type A	USB Type B	0.056	0.040
USB 3.0	USB 3.0 CD	6.8	USB Type A	open end	0.062	0.042
USB 3.0	USB 3.0 CD	6.8	USB Type A	USB Type A	0.062	0.042

Additional types upon request.

Varying parameters possible.

Smaller bend radii are possible in many cases – contact us about options.

Technical support:

Fon: +49 (0)2762 4003-0

TRAXLINE® CAT.5E / CAT.6 700 CD assembled

Shielded continuous bending hi-flex CAT.5E / CAT.6 PUR cable

Properties of the TRAXLINE® cables:

- UV-stable
- CFC-free
- Minimum bend radius
7.5 x Ø
- Halogen-free
- Flame-retardant
- Approvals:
cURus,
based on VDE,
REACH/RoHS II



CAT cable Assembling	Cable	max. Ø [mm]	Connection Motor	Connection Controller	Cable weight [kg/m]	Copper weight [kg/m]
CAT.5E straight	((4 x 2 x AWG 26))	7.1	RJ45 8pol	RJ45 8pol	0.056	0.031
CAT.5E cross-over	((4 x 2 x AWG 26))	7.1	RJ45 8pol	RJ45 8pol	0.056	0.031
CAT.6E straight	((4 x 2 x AWG 26))	8.0	RJ45 8pol	RJ45 8pol	0.065	0.034
CAT.6E cross-over	((4 x 2 x AWG 26))	8.0	RJ45 8pol	RJ45 8pol	0.065	0.034

Additional types upon request.

Varying parameters possible.
Smaller bend radii are possible in many cases – contact us about options.

TRAXLINE® KOAX 700 assembled

Shielded continuous bending hi-flex PUR data cables

Definition
from page 164**Properties of the TRAXLINE® cables:**

- UV-resistant
- CFC-free
- Minimum bend radius
15 x Ø
- Halogen-free
- Flame-retardant
- Approvals:
based on
REACH/RoHS II

Technical Information
from page 178

Picture obtainable.

Coaxial cable Assembling	Cable	max. Ø [mm]	Connection Motor	Connection Controller	Cable weight [kg/m]	Copper weight [kg/m]
1 Koaxelement	1 x (1HF50) 50 Ohm	5.6	BNC Plug	open end	0.045	0.022
1 Koaxelement	1 x (1HF50) 50 Ohm	5.6	BNC Socket	BNC Socket	0.045	0.022
1 Koaxelement	1 x (1HF50) 50 Ohm	5.6	BNC Socket	open end	0.045	0.022
3 Koaxelement	(3 x (1HF50)) 50 OHM	11.2	BNC Plug	BNC Plug	0.140	0.063
3 Koaxelement	(3 x (1HF50)) 50 OHM	11.2	BNC Plug	BNC Socket	0.140	0.063
3 Koaxelement	(3 x (1HF50)) 50 OHM	11.2	BNC Plug	open end	0.140	0.063
3 Koaxelement	(3 x (1HF50)) 50 OHM	11.2	BNC Socket	BNC Socket	0.140	0.063
3 Koaxelement	(3 x (1HF50)) 50 OHM	11.2	BNC Socket	open end	0.140	0.063
5 Koaxelement	(5 x (1HF50)) 50 OHM	14.0	BNC Plug	BNC Plug	0.230	0.099
5 Koaxelement	(5 x (1HF50)) 50 OHM	14.0	BNC Plug	BNC Socket	0.230	0.099
5 Koaxelement	(5 x (1HF50)) 50 OHM	14.0	BNC Plug	open end	0.230	0.099
5 Koaxelement	(5 x (1HF50)) 50 OHM	14.0	BNC Socket	BNC Socket	0.230	0.099
5 Koaxelement	(5 x (1HF50)) 50 OHM	14.0	BNC Socket	open end	0.230	0.099

Additional types upon request.

Varying parameters possible.
Smaller bend radii are possible in many cases – contact us about options.

Technical support:

Fon: +49 (0)2762 4003-0

TRAXLINE® FOC 700 assembled

Continuous bending hi-flex multi-mode glass fiber optic metalfree PUR cable

Properties of the TRAXLINE® cables:

- UV-stable
- CFC-free
- Minimum bend radius
7.5 x Ø
- Halogen-free
- Approvals:
based on
REACH/RoHS II



More information:
traxline.de

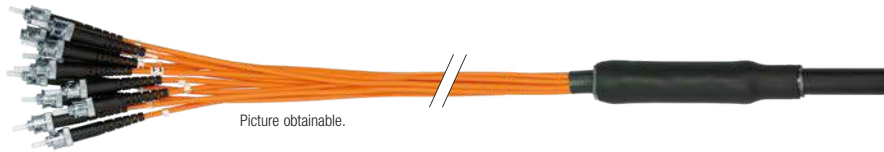

FOC cable Assembling	Cable	max. Ø [mm]	Connection Motor	Connection Controller	Cable weight [kg/m]
LWL	6 G 50/125 µm	13.4	ST Plug	LC Plug	0.140
LWL	6 G 50/125 µm	13.4	ST Plug	ST Plug	0.140
LWL	6 G 50/125 µm	13.4	LC Plug	LC Plug	0.140
LWL	6 G 62.5/125 µm	13.4	ST Plug	LC Plug	0.140
LWL	6 G 62.5/125 µm	13.4	ST Plug	ST Plug	0.140
LWL	6 G 62.5/125 µm	13.4	LC Plug	LC Plug	0.140
LWL	12 G 50/125 µm	13.4	ST Plug	LC Plug	0.140
LWL	12 G 50/125 µm	13.4	ST Plug	ST Plug	0.140
LWL	12 G 50/125 µm	13.4	LC Plug	LC Plug	0.140
LWL	12 G 62.5/125 µm	13.4	ST Plug	LC Plug	0.140
LWL	12 G 62.5/125 µm	13.4	ST Plug	ST Plug	0.140
LWL	12 G 62.5/125 µm	13.4	LC Plug	LC Plug	0.140

Additional types upon request.

Varying parameters possible.
Smaller bend radii are possible in many cases – contact us about options.

tsubaki-kabelschlepp.com

Technical support:
technik@kabelschlepp.de

TRAXLINE®

Cable engineering

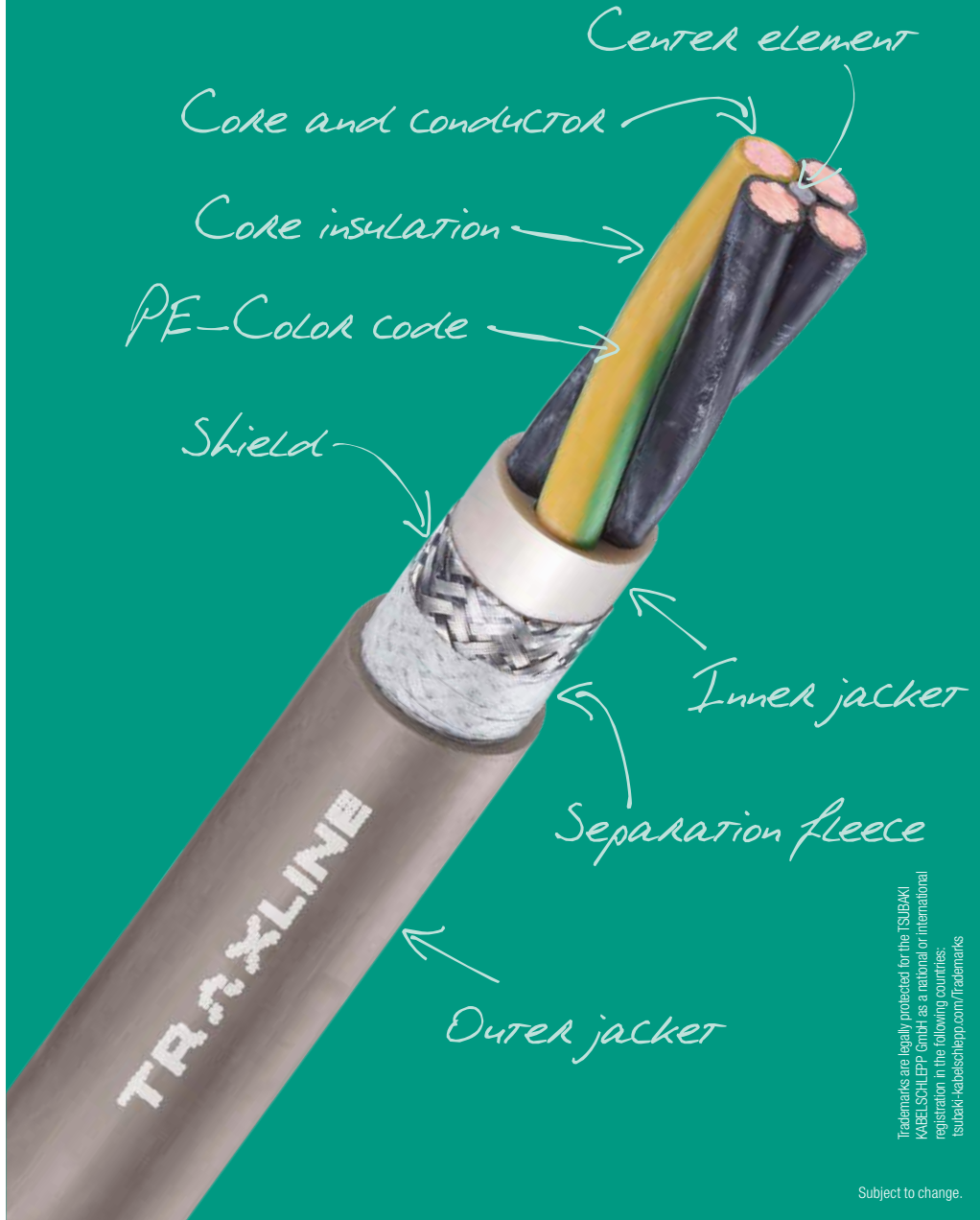

Trademarks are legally protected for the TSUBAKI
KABELSCHLEPP GmbH as a national or international
registration in the following countries:
tsubaki-kabelschlepp.com / trademarks

Content

01

TRAXLINE® Scout..... page 166

- Cable dimensioning for your cable carrier application

02

Construction elements..... page 167

- Core and conductor
- Core insulation
- Core-marking
- Center element
- Stranding of cores
- Inner jacket
- Shielding
- Outer jacket

03

Norms and standards..... page 170

- Oil-resistant
- UV-resistant
- Ozone-resistant
- Petroleum-resistant
- Halogen-free
- CFC-free
- Chlorofluorocarbons
- Flame-retardant
- Silicone-free
- REACH/RoHS II
- UL Underwriters Laboratories
- CE Communautés Européennes

04

Chemical resistance..... page 172

05

Electrical values..... page 174

- Nominal voltage
- Insulation resistance
- Electrical load capacity
- Conversion factors
- Copper surcharge

06

Materials..... page 176

- Insulation materials

More information:
traxline.de

tsubaki-kabelschlepp.com

Technical support:
technik@kabelschlepp.de

02 Design elements

2.1 Core and conductor

- Metric construction: Core-number x Cross-section in mm², e.g. 6x0.25 mm².
- AWG (American Wire Gauge) construction: Core-number x Cross-section in AWG e.g. 4xAWG22.
- Finest copper wires of class 5 or class 6 with highest requirements of cleanliness.
- The bigger the cross-section the higher may be the current flowing at the same voltage

Copper wire dimensions: AWG vs. metric

AWG-No.	Cross section [mm ²]	Diameter [mm]	AWG-No.	Cross section [mm ²]	Diameter [mm]	AWG-No.	Cross section [mm ²]	Diameter [mm]
500	254	20.7	8	8.366	3.26	24	0.205	0.511
400	203	18.9	9	6.63	2.91	25	0.163	0.455
350	178	17.3	10	5.26	2.59	26	0.128	0.405
300	152	16	11	4.15	2.3	27	0.102	0.361
250	127	14.6	12	3.3	2.05	28	0.0804	0.321
4/0	107.2	11.68	13	2.62	1.83	29	0.0646	0.286
3/0	85	10.4	14	2.08	1.63	30	0.0503	0.255
2/0	67.5	9.27	15	1.65	1.45	31	0.04	0.227
0	53.4	8.25	16	1.31	1.29	32	0.032	0.202
1	42.4	7.35	17	1.04	1.15	33	0.0252	0.18
2	33.6	6.54	18	0.823	1.024	34	0.04	0.16
3	26.7	5.83	19	0.653	0.912	35	0.0161	0.143
4	21.2	5.19	20	0.519	0.812	36	0.0123	0.127
5	16.8	4.62	21	0.412	0.723	37	0.01	0.113
6	13.3	4.11	22	0.325	0.644	38	0.00795	0.101
7	10.6	3.67	23	0.259	0.573	39	0.00632	0.0897

2.2 Core insulation

- Is covering like a skinning tube the copper core to make sure from core to core copper contact to avoid with any short circuit.
- Electrical insulation is defining the voltage level depending on material and wall thickness.
- Isolation material will be coated as per pressure extrusion around the core.
- Potential earth: construction identification contains a "G", 2 colored yellow/green core insulation for "PE" potential earth.
- Mechanical stiffness for the copper core will be provided.

2.3 Core-marking

- Core marking as per numbers referring the numbers of the cores inside this cable for easy conducting at the clamp box or assembling at the plug end.
- Additional earth conductor, marked green/yellow without numbering.
- Cores of data cables are color coded – using the defined color code as per DIN 47100 – in practice under worldwide using.
- For special constructions are different color codes are possible (Siemens, Indramat ...).

DIN 47100 color code

1 white	11 grey-pink	21 white-blue	31 green-blue	41 grey-black
2 brown	12 red-blue	22 brown-blue	32 yellow-blue	42 pink-black
3 green	13 white-green	23 white-red	33 green-red	43 blue-black
4 yellow	14 brown-green	24 brown-red	34 yellow-red	44 red-black
5 grey	15 white-yellow	25 white-black	35 green-black	
6 pink	16 yellow-brau	26 brown-black	36 yellow-black	
7 blue	17 white-grey	27 grey-green	37 grey-blue	
8 red	18 grey-brown	28 yellow-grey	38 pink-blue	
9 black	19 white-pink	29 pink-green	39 grey-red	
10 Violet	20 pink-brown	30 yellow-pink	40 pink-red	

The first colour describes the base colour of the core insulation, the second colour that of the printed ring.

2.4 Center element

- Cavities are filled delivering more stability of the complete cable.
- The center element holds the stranding safe in its position and is built like a fibrous rope.

2.5 Stranding of cores

Characteristics to differ the stranding



Layer stranding: The cores of the cable are stranded concentric positioned into the direction of the length axle – all around the center element in the middle of the cross section. High load resistance, good working inside cable carrier applications.



Hybrid stranding: Power cores and data cores in one cable, optional with BUS cores. Additional construction elements are marked with a "+" in the construction identification.



Bundle stranding: Several cores are bundled and in addition these bundles are bundled again together into the direction of the length axis Therefore useful for very high load and /or long travel applications in optional very high speed ranges.



Twisted Pair stranding: Cores get twisted as pairs together, then they get twisted with several other pairs into direction of the length axis or around the center element. This stranding will avoid cross talking (negative influences of parallel cores). Useful under high mechanical load inside cable carriers.

2.6 Inner jacket

- Stabilizing the stranding bandage, increasing the mechanical strength increasing the bending strength.
- Coated as per pressure extrusion.

2.7 Shielding

- Shielding made of Cu-braid or a foil of aluminum or a combination of both to improve electromagnetic compatibility (EMC).
Active shield: To avoid the stepping out of magnetic stray fields out of power cables.
Passive shield: To avoid the penetration/intrusion of magnetic stray fields into data transferring cables
- Single shield around all stranded cores is marked by a "C" in the name of the cable series, with brackets in the construction identification.
E.g. POWER 700 C (4G6 mm²) Cu- braid around all stranded cores.
- Double shield is marked by a "CD" in the name of the cable series, with doubled brackets in the construction identification.
E.g. ((4x2xAWG 26)) Cu-braid and aluminum foil shielding around all stranded cores with very high EMC safety.
E.g. (3x(2x0.25²)) Cu-braid around all stranded cores and all pairs with very high EMC safety.

2.8 Outer jacket

- Safety skin around inner construction against external mechanical, thermic and chemical influences as well as ultra violet radiation as well as atomic radiation in seldom cases.
- Provides stability jacketing to strengthen the complete undercover construction elements.
- Design elements covered as per pressure extruded sheath.

More information:
traxline.de

tsubaki-kabelschlepp.com

Technical support:
technik@kabelschlepp.de

03 Norms and standards

Definition
from page 164

3.1 Oil-resistant

The term describes the chemical resistance of cables against an oil or lubricant containing environment. The resistance is very important for penetrating substances into the outer jacket which may cause earlier defect. Please take care of the valid standards which are mentioned in the datasheet of every cable.

Technical Information
from page 178

3.2 UV-resistant

This term describes the resistance of the outer jacket against early aging by ultra violet radiation of sunlight. UV-resistance of colored cables may be reduced after long time. Our cables are weatherproof, too. (Outdoor – direct, Indoor – indirect). Please take care of the valid standards which are mentioned in the datasheet of every cable.

3.3 Ozone-resistant

Near to neon lamps between the cable and air builds ozone. This can cause ozone clefts, if the parts are under load or movement.

Technical support:
Fon: +49 (0)2762 4003-0

3.4 Petroleum-resistant

Our PUR cables are NEK 606 certified. Please take care of the valid standards which are mentioned in the datasheet of every cable.

3.5 Halogen-free

Halogen-free cables do not contain substances such as chlorine, fluorine, iodine or bromide. In case of fire these substances form with the extinguishing water a hydrochloric acid which affects large parts of the equipment. The smoke contains nitrous toxic gases which causes cancer. Please take care of the valid standards which are mentioned in the datasheet of every cable.

3.6 CFC-free | Chlorofluorocarbons

Due to the very detrimental effects of CFC on the environment, and in particular on the ozone layer, we do not use them neither in the in the production process nor in the products themselves.

3.7 Flame-retardant

It describes the fire behaviour of cables tested according to IEC 60331. Flame-retardant is a property of the insulation material to only catch fire after a delay when it is exposed to a naked flame and extinguishes automatically when the flame is removed. Please take care of the valid standards which are mentioned in the datasheet of every cable.

3.8 Silicone-free

If silicones are used, no paint or lacquer can be applied on the outer jacket. Therefore, we generally manufacture our products silicone-free.

3.9 REACH/RoHS II

Restriction of the use of certain hazardous substances in electrical and electronic equipment. Restricts the use of lead, mercury and cadmium in electronic devices and cables. The materials are hazardous for environment and toxic.

3.10 UL Underwriters Laboratories

This label states that the cables have been tested according to the safety UL standards in Canada (c) and the USA (us). Our certified cables have an AWM-Style number (Appliance Wiring Material; Materials used while manufacturing), which determines information about core, insulation and shield.

3.11 CE Communautés Européennes

The CE marking is affixed on a product and states that the product has been assessed before being placed on the market and that it meets EU safety, health and environmental protection requirements. The manufacturer is permanently liable for this product; the legislator only sets the conditions.

More information:
traxline.de

tsubaki-kabelschlepp.com

Technical support:
technik@kabelschlepp.de

04 Chemical resistance

Definition
from page 164Technical Information
from page 178Technical support:
Fon: +49 (0)2762 4003-0

 online-engineer.de
Cable Carrier Configurator

Chemical product	Resistance								
	Control 200	Control/Power 400	Control/Power 700	Data 700	Control/Power 700 C	System 700 C	Control/Power 1000	Data 1000	Control/Power 1000 C
Inorganic chemicals / aqueous solutions, neutral									
Water	✓	✓	✓	✓	✓	✓	✓	✓	✓
Common salt (10 %)	✓	✓	✓	✓	✓	✓	✓	✓	✓
Sodium sulphate (10 %)	✓	✓	✓	✓	✓	✓	✓	✓	✓
Aqueous solutions, alkaline									
Soda (10 %)	✓	✓	✓	✓	✓	✓	✓	✓	✓
Aqueous solutions, acidic									
Aqueous solutions, oxidising	⊖	⊖	✓	✓	✓	✓	✓	✓	✓
Hydrogen peroxide (3 %)	✓	✓	✓	✓	✓	✓	✓	✓	✓
Potassium permanganate (2 %)	✓	✓	✓	✓	✓	✓	✓	✓	✓
Inorganic acids									
Concentrated hydrochloric acid	✗	✗	✗	✗	✗	✗	✗	✗	✗
Hydrochloric acid (3 %)	✓	✓	✓	✓	✓	✓	✓	✓	✓
Concentrated sulphuric acid	✗	✗	✗	✗	✗	✗	✗	✗	✗
Sulphuric acid 3 %)	✓	✓	✓	✓	✓	✓	✓	✓	✓
Concentrated nitric acid	✗	✗	✗	✗	✗	✗	✗	✗	✗
Nitric acid (3 %)	⊕	⊕	⊕	⊕	⊕	⊕	⊕	⊕	⊕
Inorganic alkalis									
Concentrated sodium hydroxide	✗	✗	✗	✗	✗	✗	⊕	⊕	⊕
Sodium hydroxide (3 %)	✓	✓	✓	✓	✓	✓	✓	✓	✓
Concentrated caustic potash solution	✗	✗	⊕	⊕	⊕	⊕	⊕	⊕	⊕
Caustic potash solution (3 %)	✓	✓	✓	✓	✓	✓	✓	✓	✓
Concentrated ammonia	⊕	⊕	✗	✗	✗	✗	✓	✓	✓
Ammonia (3-25 %)	✓	✓	✓	✓	✓	✓	✓	✓	✓

Chemical product	Resistance								
	Control 200	Control/Power 400	Control/Power 700	Data 700	Control/Power 700 C	System 700 C	Control/Power 1000	Data 1000	Control/Power 1000 C
Organic chemicals / organic acids									
Concentrated acetic acid	✗	✗	☺	☺	☺	☺	☺	☺	☺
Acetic acid (10 % in H ₂ O)	✓	✓	✓	✓	✓	✓	✓	✓	✓
Tartaric acid (10 % in H ₂ O)	✓	✓	✓	✓	✓	✓	✓	✓	✓
Citric acid (10 % in H ₂ O)	✗	✗	✓	✓	✓	✓	✓	✓	✓
Ketones									
Acetone	✗	✗	✗	✗	✗	✗	☺	☺	☺
Methyl ethyl ketone (MEK)	✗	✗	✗	✗	✗	✗	☺	☺	☺
Alcohols									
Ethyl alcohol (white spirits)	✗	✗	☺	☺	☺	☺	✓	✓	✓
Isopropyl alcohol	✗	✗	✓	✓	✓	✓	✓	✓	✓
Diethylene glycol	☺	☺	✓	✓	✓	✓	✓	✓	✓
Aromatics									
Toluol	✗	✗	✗	✗	✗	✗	✗	✗	✗
Xylol	✗	✗	✗	✗	✗	✗	✗	✗	✗
Fuels									
Petrol	✗	✗	✓	✓	✓	✓	✓	✓	✓
Diesel	☺	☺	✓	✓	✓	✓	✓	✓	✓
Kerosene	✗	✗	✓	✓	✓	✓	✓	✓	✓
Synthetic oils / lubricating oil									
ASTM oil #2	✓	✓	✓	✓	✓	✓	✓	✓	✓
Hydraulic fluid									
Based on mineral oil	✗	✗	✓	✓	✓	✓	✓	✓	✓
Based on glycol	✗	✗	✓	✓	✓	✓	✓	✓	✓
Based on synthetic ester	✗	✗	✗	✗	✗	✗	✗	✗	✗
Vegetable oils									
Rapeseed oil	☺	☺	✓	✓	✓	✓	✓	✓	✓
Olive oil	☺	☺	✓	✓	✓	✓	✓	✓	✓
Soybean oil	☺	☺	✓	✓	✓	✓	✓	✓	✓
Other									
Seawater	✓	✓	✓	✓	✓	✓	✓	✓	✓

Abbreviations:

- ✓ resistant
- ✗ not resistant
- ☺ short-term resistance
- ⊖ no data

More information:
traxline.de

tsubaki-kabelschlepp.com

Technical support:
technik@kabelschlepp.de

05 Electrical values

Definition
from page 164

5.1 Nominal voltage

The nominal voltage defines the working range of the cable in dependence of a standard. The amount of the acceptable voltage differs in dependence of the approbation.

Technical Information
from page 178

5.2 Insulation resistance

The used insulation materials have resistance properties to stop the current flow. The insulation resistance is in inverse proportion to the cable length. The insulation resistance is an indication of quality of the insulation material between two cores or a core and the shield.

Technical support:
Fon: +49 (0)2762 4003-0

5.3 Electrical load capacity

These values are extracted from DIN VDE 0298-4. The laying procedure „Continuous flexible/moving in a cable carrier“ is not standardized. Due to this fact these values are for orientation only. Please observe reduction factors for cumulation of cables and varying ambient temperatures while selecting cables. Please observe additional standards which will be security-relevant for the application.

All data in this publication are to be used as guidelines for planning purposes only. In particular, we do not guarantee that the products supplied suit the users application. It is the customer's responsibility to verify that our products fit the users application specifications.

Cross section	PVC	PUR	PUR Single cores
0.14 mm ²	2 A	2 A	2 A
0.25 mm ²	4 A	4 A	4 A
0.34 mm ²	6 A	6 A	6 A
0.5 mm ²	9 A	9 A	9 A
0.75 mm ²	12 A	12 A	15 A
1 mm ²	15 A	15 A	19 A
1.5 mm ²	18 A	23 A	24 A
2.5 mm ²	26 A	32 A	32 A
4 mm ²	34 A	42 A	42 A
6 mm ²	44 A	54 A	54 A
10 mm ²	61 A	75 A	73 A
16 mm ²	82 A	100 A	98 A
25 mm ²	108 A	127 A	141 A
35 mm ²	135 A	158 A	176 A
50 mm ²	168 A	192 A	216 A
70 mm ²	207 A	246 A	279 A
95 mm ²	250 A	298 A	342 A
120 mm ²	292 A	346 A	400 A
150 mm ²	335 A	399 A	464 A
185 mm ²	382 A	456 A	533 A
240 mm ²	453 A	538 A	634 A
300 mm ²	523 A	621 A	736 A
400 mm ²			868 A
500 mm ²			998 A
700 mm ²			1240 A

DIN VDE 0298-4
Page 33, chart 11, column 5

DIN VDE 0298-4
Page 23, chart 6, column 5

DIN VDE 0298-4
Page 33, chart 11, column 2

DIN VDE 0298-4
Page 23, chart 6, column 7

5.4 Conversion factors for different ambient temperatures

Ambient temperatures in °C	Permitted/recommended operating temperature at conductor					
	40 °C	60 °C	70 °C	80 °C	85 °C	90 °C
	Conversion factors, must be applied to the loading capacity information!					
10	1.73	1.29	1.22	1.18	1.17	1.15
15	1.58	1.22	1.17	1.14	1.13	1.12
20	1.41	1.15	1.12	1.10	1.09	1.08
25	1.22	1.08	1.06	1.05	1.04	1.04
30	1.00	1.00	1.00	1.00	1.00	1.00
35	0.71	0.91	0.94	0.95	0.95	0.96
40	–	0.82	0.87	0.89	0.90	0.91
45	–	0.71	0.79	0.84	0.85	0.87
50	–	0.58	0.71	0.77	–	0.82
55	–	0.41	0.61	0.71	–	0.76
60	–	–	0.50	0.63	–	0.71
65	–	–	0.35	0.55	–	0.65
70	–	–	–	0.45	–	0.58
75	–	–	–	0.32	–	0.50
80	–	–	–	–	–	0.41
85	–	–	–	–	–	0.29
90	–	–	–	–	–	–
95	–	–	–	–	–	–

More information:
traxline.de

tsubaki-kabelschlepp.com

5.5 Calculation of the copper surcharge

The copper contained in cables is already calculated into the sales price at € 150.00/100 kg (copper basis). The current price of copper, the German DEL quotation, rises and falls on a daily basis. The difference between the copper basis and the daily quotation is calculated and added to the cable price (copper surcharge).

The formula for calculating the copper surcharge (€/m):

$$\frac{\text{Copper weight (kg/m)} \times ((\text{DEL quote (€/100 kg)} + 1 \% \text{ procurement costs)}) - \text{copper basis (€/100 kg)}}{100}$$

DEL quotation

The DEL quotation (Deutsches Elektrolytkupfer für Leitzwecke / German Electrolytic Copper for Conductor Purposes) is a market quotation for copper used in cables with a purity of over 99.5 %.

Copper basis

Is the proportional value of copper already included in the cable price. This is € 150.00/100 kg copper for all TRAXLINE® cables.

Copper weight

The copper weight is the weight of the copper in a cable. This can vary greatly depending on the cross-section and the number of cores used, and is specified in kilograms per meter (kg/m).

Example:

Copper weight: 0.152 kg/m
DEL notation: 300.00 €/100 kg
Copper base: 150.00 €/100 kg

Rebates and discounts do not apply to the copper surcharge. The copper surcharge is indicated separately in our invoices..

$$\frac{0.152 \text{ kg/m} \times ((300.00 \text{ €/100 kg} + 3.00 \text{ €/100 kg}) - 150.00 \text{ €/100 kg})}{100} = 0.23 \text{ €/m copper surcharge per meter of cable}$$

Technical support:
technik@kabelschlepp.de

06 Materials

Definition
from page 164

6.1 Used plastics

The plastics which are used in our TRAXLINE cables can be divided in the following material groups:

PVC – Polyvinyl chloride

The most used material in cable manufacturing industry used for insulation and outer jacket. By adding different substances to the composition like softener, stabilizer or colors the properties of the material can be changed and influenced as needed. PVC has a very good dielectric insulating properties and a good slippage.

PUR – Polyurethane

PUR has very high notch toughness and a very high chemical resistance and is used for insulation, inner jacket and outer jacket. With the high flexibility, even at cold temperatures and very low water absorption PUR is qualified especially for outdoor applications. In addition PUR has a high resistance to wear of friction.

PP – Polypropylene

Because PP has very high values of breakdown of a dielectric it is a very good material for electric insulation and inner jacket. In combination with a PVC/PUR/TPE outer jacket it is possible to manufacture a cable for very hi-flex applications in cable carrier.

TPE-0 – Thermoplastic Elastomer

Thermoplastic Elastomer based on Olefin. Used for outer jackets of cables for high demanding applications and very long travel-length.

Technical Information
from page 178Technical support:
Fon: +49 (0)2762 4003-0

Notes

TRAXLINE®

Technical annex

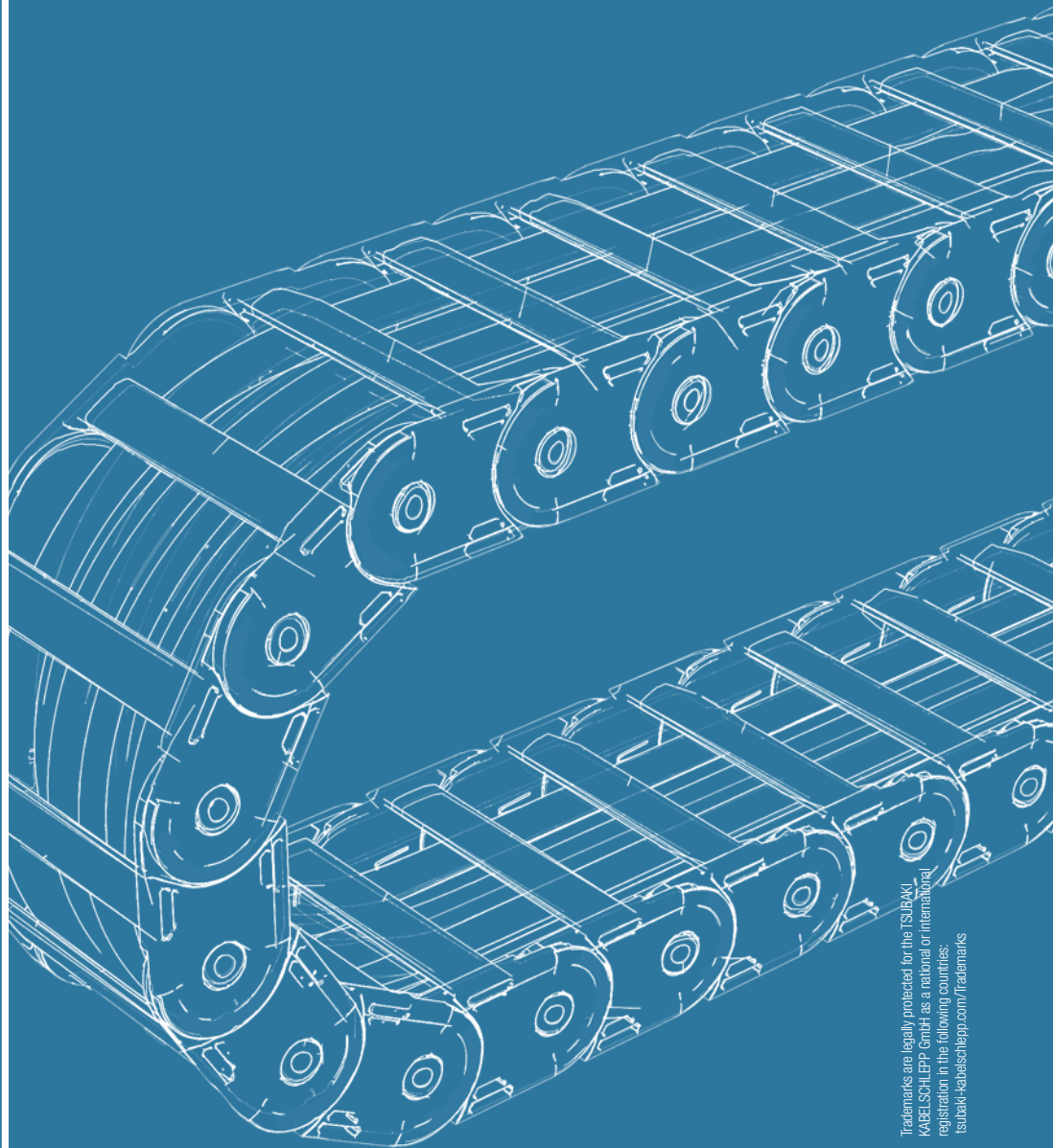

Trademarks are legally protected for the TSUBAKI
KABELSCHLEPP GmbH as a national or international
registration in the following countries:
tsubaki-kabelschlepp.com/ Trademarks

Content

01

Selecting a suitable cable carrier page 180

- Required basic data for determination
- Selecting the suitable version
- Defining the cable carrier size
- Determining the cable carrier length (L_k)
- Connection height, pretension & installation height
- Consideration of stability
- Consideration of relative displacement

02

Placement guidelines for cables and hoses..... page 188

- General guidelines
- Placement of pressure hoses
- Strain relief
- Strain relief for gliding cable carriers

03

Installation variants page 192

- Examples for your application

More information:
traxline.de

tsubaki-kabelschlepp.com

Technical support:
technik@kabelschlepp.de

01 Selecting a suitable cable carrier

Definition from page 164

Technical Information from page 178

Technical support: Fon: +49 (0)2762 4003-0

online-engineer.de
Cable Carrier Configurator

1.1 Required basic data for determination

The cable carrier is selected based on different factors which have to be considered in combination. The following parameters should therefore be already available when starting to select a cable carrier:

- **Installation of cables and hoses**
(Number and diameters of the installed cables and hoses as well as the cable weight including media (kg/m), required minimum bending radius)
- **Dynamic parameters**
(Travel speed, acceleration/deceleration, desired motion cycles)
- **Motion sequence**
(For which type of motion is the cable carrier used?)
- **Installation situation**
(How much space is available? Installation width? Installation height?)
- **Operating temperature**
- **Contamination and degree of contamination**
(Which type of contamination? Which amount?)
- **Application-specific ambient influences**
(e.g. chips, oil, moisture, chemicals)

1.2 Selecting a suitable version

TSUBAKI Kabelschlepp offers a variety of cable carriers for all areas of application. The suitable product can be roughly determined with the available basic data.

Selecting the suitable material: side bands made of steel or plastic?

In addition to the environmental conditions, the selection of the suitable material is determined by the dynamic parameters and the load on the cable carrier. Plastic cable carriers have become established in many areas of application over the years. The application should always be examined in detail beforehand, though. The following table shows the operating parameters as a configuration tool for the suitable cable carrier material:

Operating conditions	Plastic	Steel	Operating conditions	Plastic	Steel
Travel speed > 2 m/s	+	-*	Vacuum	-	+***
Travel cycle > 1 million	+	-*	Extremely rough operating conditions (e.g. heavy industry, mining, drilling)	•	+
Continuous temperature < -40° C	-**	+	Very high mechanical load	•	+
-40° C to +100° C	+	+			
> +100° C	-**	+			
Acidic environment	-	+***			
Radioactive radiation	-	+***			

+ very suitable * possible as custom version
 • suitable ** special material available
 - not suitable *** stainless steel version available

Our technical support can provide help for critical applications: technik@kabelschlepp.de

Selecting the cable protection: open or closed cable carrier?

The selection of the suitable cable carriers can be further limited with the question whether the guided cables require additional protection (e.g. against foreign bodies) and whether a cable carrier with a cover system is practical.

The following table is a simple guideline; the exact choice should be determined after detailed examination of the specific application. In many cases, closed cable carriers are also used to hide the cables for visual reasons.

For very large accumulations of fine contamination (e.g. dust or sand), especially in combination with moisture, we advise against using the cover systems. This affects the function of the overlapping covers substantially.

Cover systems are available for steel and plastic cable carriers.

Operating conditions	Open cable carriers	Covered cable carriers
Coarse contamination (e.g. chips, metal parts, glass splinters)	•	+
Hot chips/metal spatter	–	+*
Visual protection (hiding the cables)	–	+
Very high incidence of fine contamination (e.g. sand, dust, scale)	•/+	–
Very fine contamination and moisture (e.g. moist dust)	•/+	–

- + very suitable
 - suitable
 - not suitable
- * Also possible as steel band cover
Special materials for covers on plastic cable carriers possible



Example:
Cover system with chips



Negative example:
Cover system with high dust accumulation

According to the specification plastic/steel and open/closed, you can select the suitable cable carriers according to the following diagram in the respective catalog chapter:

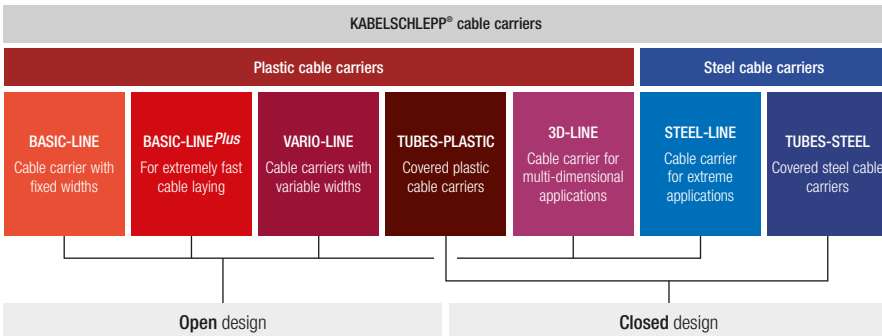

More information:
traxline.de

tsubaki-kabelschlepp.com

Technical support:
technik@kabelschlepp.de

1.3 Defining the cable carrier size

The number and diameter of the cables to be installed play a major role here. Very often, the dimensions of the installation space for using a cable carrier are very limited. Both these prerequisites therefore have to be balanced.

The basic data of the cables to be installed are required for the further configuration of the cable carrier:

- Type (cable or hose)
- Cable weight incl. media (q_z)
- Outer diameter (d)
- Minimum bending radius (KR_{min})

Please select a cable carrier with a sufficient inner height. Adequate space on the side for placing the cables should also be planned for the initial configuration. They have to be arranged freely in the cross section of the cable carrier. The following minimum values for the required space apply:

Cables: $1.1 \times d$ (for diameter $d < 20$ mm, minimum required space: $d + 2$ mm)

Hoses: $1.2 \times d$ (for diameter $d < 20$ mm, minimum required space: $d + 4$ mm)

More information for installing cables can be found in chapter *Placement guidelines* on page 188.

Definition from page 164

Technical Information from page 178

Technical support: Fon: +49 (0)2762 4003-0

The first draft for a so-called stay pattern can then look as follows, for example:

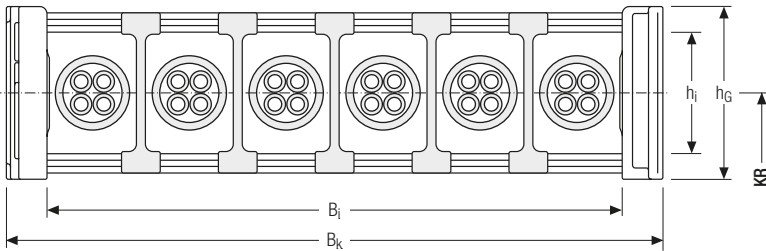

It is possible that the cable carrier becomes too wide with regard to the permitted installation dimension. In this case, a larger cable carrier can be used in combination with one of the divider systems. The placement could then look as follows, for example:

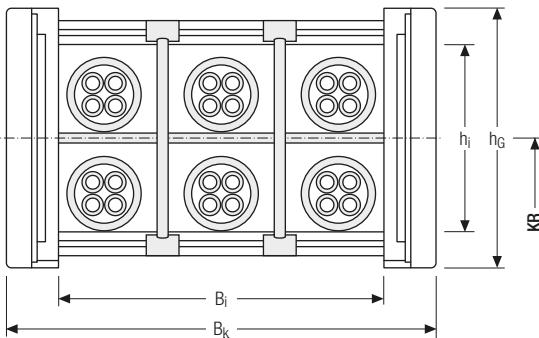

For the installation of cables in the cable carrier, please also take the selected installation variant into account (see page 192) which can have additional implications for loading the cable carrier. The different available stay variants (e.g. hole stay, tube stay) also allow different variations to suit the application.

This initial draft still has to be verified with regard to the further configuration of the cable carrier in the following (e.g. unsupported use).

Determining the bending radius KR

The chapter for the selected cable carrier contains the sizes of the available bending radii. The selection of the bending radii depends on the cables used. The information from the cable manufacturer regarding the dynamically moving minimum bending radius have to be taken into account for this.

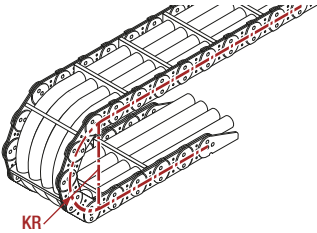

The selected bending radius of the cable carrier has to be equal to or greater than the largest minimum bending radius of the cables to be installed.

We recommend using KABELSCHLEPP® cables which were specially designed for use in cable carriers.

More information:
traxline.de

1.4 Determining the cable carrier length L_k for simple linear travel

It is practical to place the fixed point connection at the center of the travel path. This provides the shortest connection between fixed and movable driver point and therefore the most economical cable carrier and cable length. Of course your cable carrier can also be installed with a fixed point outside of the center of the travel path. The calculation follows these examples:

For **fixed point at the center** of travel path L_s , the following applies for cable carrier length L_k :

Cable carrier length L_k

$$L_k \approx \frac{L_s}{2} + L_B$$

Cable carrier length L_k rounded to pitch t

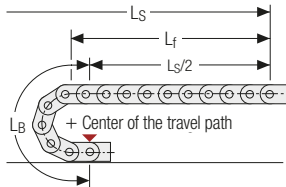

The length of carrier in bend L_B is determined according to the selected cable carrier type:

Type	Length of carrier in bend L_B
Plastic cable carriers	$L_B = KR \times \pi + 2 \times t$
Steel cable carriers	$L_B = KR \times \pi + 4 \times t$
QUANTUM® series	$L_B = KR \times \pi + 12 \times t$
TKR series	$L_B = KR \times \pi + 2 \times t$

The calculated values can be found in the tables in the respective individual chapters.

tsubaki-kabelschlepp.com

Technical support:
technik@kabelschlepp.de

For **fixed point outside of the center** of travel path L_s , the following applies for cable carrier length L_k :

Cable carrier length L_k

$$L_k \approx \frac{L_s}{2} + L_B + |L_v|$$

Cable carrier length L_k rounded to pitch t

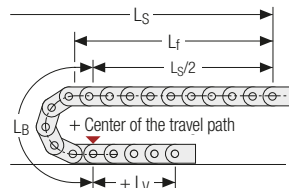
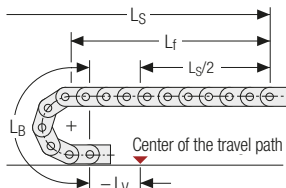

Configuration guidelines | Selecting the cable carrier

Verification of the load values for unsupported arrangement

The term “unsupported arrangement” describes the condition when the upper run moves parallel to the lower run across the entire horizontal travel length.

Definition from page 164

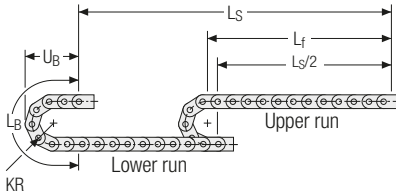

The unsupported arrangement is the most common use of cable carriers. The unsupported length L_f resulting from the travel length, and its load on the cable carrier is determined with the cable weight to be guided q_z from the load diagram.

The load diagram therefore marks the area of the unsupported length L_f in which the cable carrier has no appreciable sagging or, in reverse conclusion, the maximum cable weight at which the cable carrier does not yet sag. If the travel length or the cable weight increases above the value stated in the diagram, the cable carrier starts to sag.

Technical Information from page 178

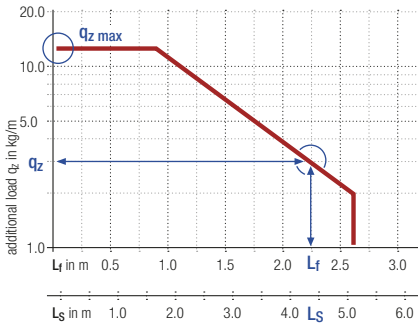

Technical support: Fon: +49 (0)2762 4003-0



The specific load diagrams can be found in the individual chapters. Please note that the diagrams were determined with a specific intrinsic cable carrier weight. This means that the usable additional load can be reduced for large cable carrier widths or for cover systems.

Furthermore, the upper value q_z in the diagram indicates the maximum additional load of the cable carrier.

This value must not be exceeded.

The figure on the left shows an example for a load diagram with the most important parameters for determining the respective cable carrier load.

According to definition, the unsupported length L_f is the length at which the upper run of the cable carrier has no appreciable sag.

For steel cable carriers, sagging is not permitted as a rule. The higher flexibility of the plastic cable carriers allow a slight increase of the additional load or of the unsupported length. As a rule, we advise against this *unsupported arrangement with permitted sag L_D* for reasons of dynamics and appearance.

Increased wear of the links also has to be expected. It cannot be ruled out, however, that in individual cases a solution may have to be implemented in this way at low travel speeds. In this case, please request the corresponding values from us.

We will be happy to advise you.

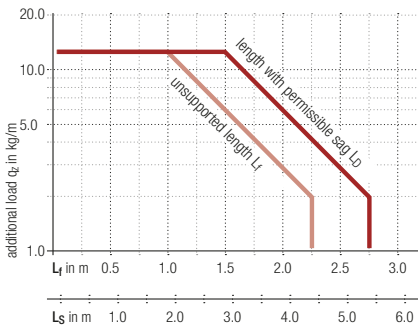

Exceeded the load diagram?

There are several options if the unsupported length of the cable carrier is exceeded:

- Selecting a more sturdy cable carrier with a longer unsupported length and higher additional load
- Using a multi-band carrier for increasing the additional load
- Supporting the upper run after the fixed point:
 - depending on the dynamic parameters, this arrangement can practically double the travel length. We are happy to help with configuring a suitable support structure.
- For very long travel lengths, the cable carrier has to be configured as gliding or rolling.

More information on these installation variants can be found from page 192.

More information: traxline.de

1.5 Connection height, pretension & installation height

Kabelschlepp cable carriers are manufactured with pretension as a standard in order to implement the most extensive unsupported length possible. This produces an elevation of the upper run in the area of the unsupported length and is already considered in the load diagram.

The pretension increases the installation height of the cable carrier to the total value H_z . The connection height H and the installation height H_z are determined for each cable carrier type according to the following guidelines.

Connection height H and installation height H_z for plastic cable carriers

The values for determining the connection height H can be found in the respective individual chapters. They are generally determined as follows:

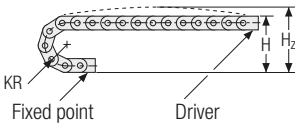

Installation height H_z is also listed in the respective individual chapters as an allowance for the pretension, specifically for each cable carrier.

Type	Connection height H
Plastic cable carriers*	$H = 2 KR + h_G$
M1300 series	$H = 2 KR + 1.5 h_G$
TKHD series	$H = 2 KR + 1.5 h_G$
QUANTUM® series	$H = 2 KR + \frac{4}{3} h_G$
TKR0150 series	$H = 2 KR + 50 \text{ mm}$
TKR0200 series	$H = 2 KR + 82 \text{ mm}$
TKR0260 series	$H = 2 KR + 98 \text{ mm}$
TKR0280 series	$H = 2 KR + 112 \text{ mm}$

* not for M1300

tsubaki-kabelschlepp.com

Technical support: technik@kabelschlepp.de



TSUBAKI KABELSCHLEPP technical support

If you have any questions about the configuration of cable carriers or other technical details please contact our technical support at technik@kabelschlepp.de. We will be happy to help you.

Configuration guidelines | Selecting the cable carrier

Installation height H_z for steel cable carriers

Due to the higher stability of steel cable carriers, the pretension z can already be taken into account on unsupported arrangements by slightly increasing the connection height H . This is based on the following calculation:

Connection height H for systems without support (unsupported)

$$H = 2 KR + 1.5 h_G$$

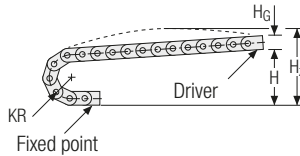

If the unsupported length is increased with support rollers or a continuous support frame, the upper run has to be placed parallel to the support plane.

Connection height H for systems with support

$$H = 2 KR + h_G$$

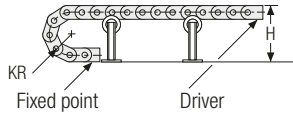

To be sure, another verification of the installation height H_z should be carried out for steel cable carriers depending on the pretension and cable carrier length. The following rule of thumb applies:

Installation height H_z

$$H_z = H + z$$

Pretension
 $z \approx 10 \text{ mm/m cable carrier length}$

For example, the installation height H_z for a cable carrier length of $L_k = 5000 \text{ mm}$ increases by 50 mm. Depending on the installation variant, it is still necessary to operate the cable carrier without or with reduced pretension. This is possible on almost all types.

Definition from page 164

Technical Information from page 178

Technical support:
 Fon: +49 (0)2762 4003-0

1.6 Consideration of stability

In the tension end position, the stability of the cable carrier must be considered. For extensive unsupported lengths, the remaining small support area at the fixed point can reduce the stability for very narrow cable carriers. Accordingly, the ratio between bending radius KR and outer cable carrier width B_k should always be taken into account for dimensioning of the cable carrier.

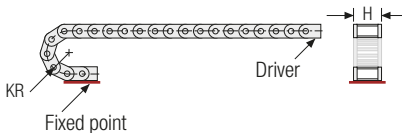

— Support area

If the outer cable carrier width on an extensive unsupported length is significantly smaller than the required bending radius, the option of a lateral support should be considered if stability seems at risk. In this case, please contact our technical support.

1.7 Consideration of relative displacement

An arrangement where the cables are placed next to each other and separately should be preferred. This arrangement is recommended to keep the relative displacement of the cables as low as possible.

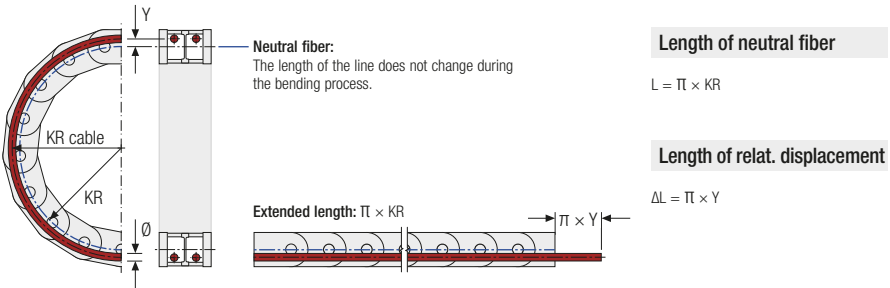

Due to the off-center placement, the cables move in the cable carrier by the value of the relative displacement. This can cause increased cable wear on the stays.



More information:
traxline.de

tsubaki-kabelschlepp.com

Technical support:
technik@kabelschlepp.de

02 Placement guidelines for cables and hoses in cable carriers

Cable carriers are designed to protect moving energy lines and data lines which can be guided together in a variety of combinations. The following chapters list the guidelines which ensure configuration of the cable carrier system for maximum service life.

1.1 General guidelines

A "direction of view" is defined to allow a clear definition of the position of the cables in the cable carrier. For KABEL-SCHLEPP cable carriers, the view is always into the driver.

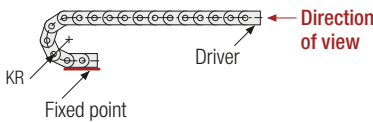

 Only cables which are suitable for use in cable carriers should be used, e.g. TRAXLINE® cables.

Cables and hoses have to be able to move freely in the cable carrier. They must not be attached or tied together.

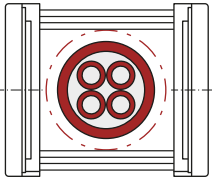

The following guide values apply for dimensioning the required clearance:

- **For round cables:**
10 % of the diameter*
- **For flat cables:**
10 % of the cable width/thickness each
- **For hoses:**
20 % of the diameter for pressure hoses**
10 % - 20 % for unpressured/low-pressure hoses*

* For diameter $d < 20$ mm, min. space requirement: $d + 2$ mm

** For diameter $d < 20$ mm, min. space requirement: $d + 4$ mm

Weight distribution for installation

For the installation of cables and hoses, please ensure that the cable weight is symmetrically distributed across the width of the cable carrier. Even loading can help the cable carrier to achieve its maximum service life.

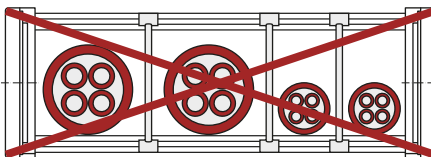

Poor weight distribution

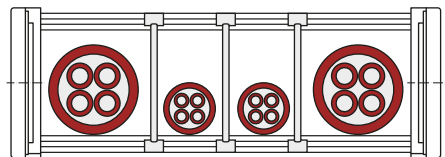

Good weight distribution

No cable loops

When cutting the cables for installation in the cable carrier, remove the cable from the coil tangentially and not in loops.



Do not twist cables

When cutting the cables for installation in the cable carrier, unwind the cable from the drum without twisting it.



More information:
traxline.de

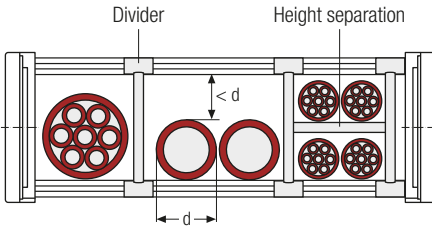

Separating multiple cables

Adjacent cables with strongly differing diameters should be separated by dividers. Directly adjacent placement of cables with strongly differing diameters has to be avoided. If this is unavoidable, ensure that the remaining clearance height is smaller than the smallest cable diameter. This is the only way to prevent the cables from becoming tangled.

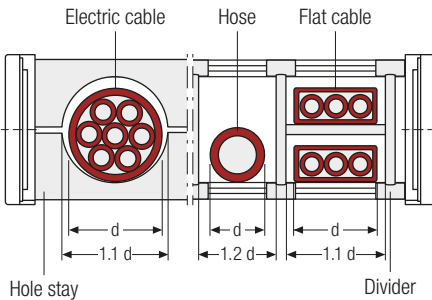

Multiple layers

When placing cables in multiple layers, we recommend installing a height separation between the individual layers for electric cables.

Individually manufactured hole stays or partitions through dividers prevent adjacent cables from rubbing against each other. In many cases, it is beneficial to place each cable in a separate chamber.

A height separation always has to be installed between multiple layers of flat cables.

tsubaki-kabelschlepp.com

Technical support:
technik@kabelschlepp.de

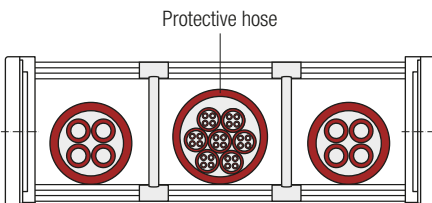

Collating in protective hoses

Thin hi-flex cables with low bending strength have to be loosely bundled and sorted in a protective hose. The cross section of the protective hose has to be significantly larger than the sum of the individual cable cross sections.

As a guideline for determining the cross section: each cable takes up approx. 10 % of its diameter as a clearance all around.

Technical annex | Placement guidelines

It always has to be ensured that the cables can run through the bending radius KR without any tensions or force.

They have to move freely lengthwise and must not exert any towing forces on the cable carrier in the bend.

For multiple layer, the cables have to be placed in such a way that they also have enough clearance between them in the cable carrier bend.

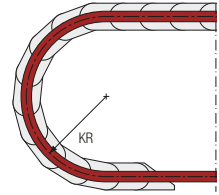

Definition from page 164

Technical Information from page 178

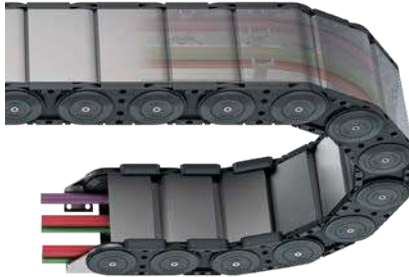

Installing cables and hoses in closed cable carriers

For large numbers of electric cables in covered cable carriers or in energy conduits, the current carrying capacity of the cables has to be configured according to the applicable standards, regulations and recommendations so that the maximum permissible temperatures for the corresponding cable materials and the cable carrier material are not exceeded.

For your configuration, please note that this is a closed system.

1.2 Placement of pressure hoses

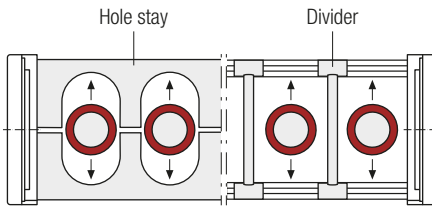

The following applies regardless of the partitioning type of the stay cross section:

Pressure hoses have to be able to move freely because they expand or contract during pressure changes!

Expansion or contraction can be compensated in the bending radius area. The required clearance can be calculated depending on the proportional change (manufacturer's information).

If technically possible, we recommend placing each pressure hose in a separate chamber.

Pressure hoses are often attached to a tube directly before the driver and fixed point connection. Length differences, which result from the pressure change but also from manufacturing tolerances during installation of the hoses, can result in increased wear in the area of the bending radius.

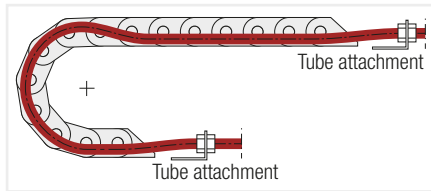

Hose too long

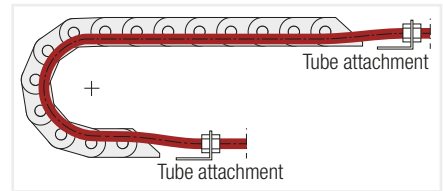

Hose too short

For your configuration, please take into account a suitable length compensation for the hoses so they can run through the bending radius without tensions or force. It is often sufficient to provide a loop before the fixed point to compensate for the hose length.

Technical support:
Fon: +49 (0)2762 4003-0

1.3 Strain relief

The strain relief for the cables depends on cable type, length of the cable carrier and installation variant. Generally, it has to be ensured that the retention force is applied on the largest possible area of the outer jacket so that the cables are not crushed while also preventing displacement of the cables.

- Within the **unsupported area** of the cable carrier, electric cables should preferably be equipped with a strain relief on the driver and on the fixed point. For short travel lengths and smaller cable diameters, we recommend the use of strain relief combs and cable ties for this application. LineFix clamps can also be used for larger cable carriers which use a C-rail.
- **Longer travel lengths**, which require gliding operation of the cable carrier, should also be equipped with strain relief on the driver and on the fixed point. Secure strain relief, e.g. with LineFix clamps, has to be provided especially at the driver connection where push and pull forces are present. When using the strain relief at the fixed point of a gliding cable carrier, it primarily has to be ensured that the installed height of the strain relief is significantly smaller than the chain link height h_G in order to prevent a collision. For slow travel speeds, it is often sufficient to provide fixation with a strain relief comb and cable ties on the fixed point of gliding cable carriers.
- For vertically operating cable carriers, the cables also have to be provided with a strain relief on the driver and on the fixed point. For hanging cable carriers with very long travel lengths and high cable weights, it can be practical to install a double strain relief arrangement on both sides.
- Pressure hoses which will not be bolted on in direct proximity to the driver or fixed point also have to be provided with a strain relief, in the same way as the cables. Block clamps are to be used for the strain relief of hoses, since the hose cross-section can be compressed when using clamps!

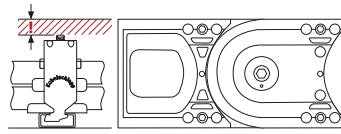

More information:
traxline.de

tsubaki-kabelschlepp.com

1.3.1 Strain relief for gliding cable carriers

Strain relief on the driver cable carrier end

After moving the cable carrier driver (moving cable carrier end) to the **pushing end position**, the cables are provided with a strain relief at the moving cable carrier end.

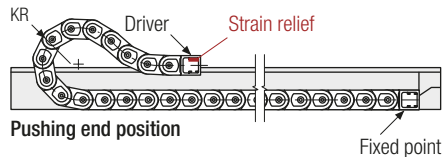

Correct cable length in the cable carrier

After moving the cable carrier driver (moving cable carrier end) to the **pulling end position** of the cable carrier, the cables are checked for tension-free length in the bend and, if necessary, "fed further into the cable carrier".

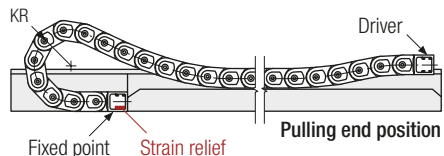

Strain relief on the fixed point cable carrier end

With this tension-free "inserted length", the cables are finally provided with a strain relief at the fixed point cable carrier end.

i Test operation of the cable carrier: After an initial test run, check the tension-free cable routing and, if necessary, adjust the strain relief at the fixed point.



Technical support:
technik@kabelschlepp.de

03 Installation variants

Definition from page 164

Overview of installation variants

Technical Information from page 178

Technical support:
Fon: +49 (0)2762 4003-0

online-engineer.de
Cable Carrier Configurator

Code	Symbol	Designation	Plastic cable carriers	Plastic tubes	Steel cable carriers	Steel tubes	Page
INV 1		Horizontal arrangement, unsupported	•	•	•	•	194
INV 2		Horizontal arrangement, with support	◦ / –	◦ / –	•	•	195
INV 3		Horizontal arrangement, gliding in guide channel	•	•	•	•	196
INV 4		Vertical arrangement, hanging	•	•	•	•	197
INV 5		Vertical arrangement, standing	•	•	•	•	198
INV 6		Horizontal arrangement, rotated 90° (straight)	•	•	◦	◦	199
INV 7		Horizontal arrangement, rotated 90° (circular)	◦	–	◦	–	201

- Standard version
- Customized
- Not possible

Technical annex | Installation variantens

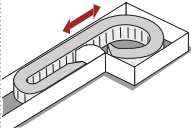
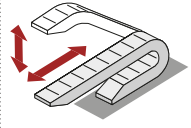
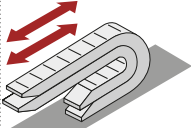
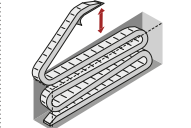
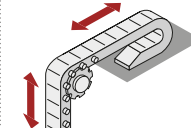
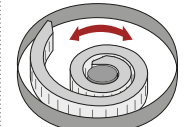
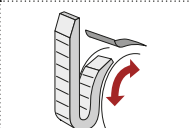
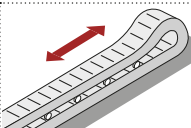
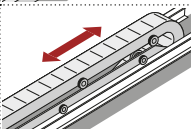
Code	Symbol	Designation	Plastic cable carriers	Plastic tubes	Steel cable carriers	Steel tubes	Page
INV 8		Horizontal arrangement, rotated 90° (rolled)	•	•	○	○	203
INV 9		Horizontal-vertical combined arrangement	•	•	•	•	203
INV 10		Unsupported arrangement, nested	•	•	•	•	203
INV 11		Zig-zag arrangement	○	○	○	○	204
INV 12		Vertical arrangement, hanging with support bolt	–	–	○	○ / –	204
INV 13		Horizontal arrangement, curled	•	•	○	○ / –	205
INV 14		Vertically rotating arrangement, hanging	○	–	○	–	205
INV 15		Roller chain	•	○	–	–	205
INV 16		Arrangement with continuous support structure	○	○	○	○	206

More information:
traxline.de

tsubaki-kabelschlepp.com

Technical support:
technik@kabelschlepp.de

INV 1

Horizontal arrangement, unsupported

Definition from page 164

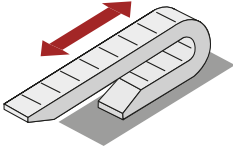

i For unsupported arrangement, the driver connection of the cable carrier is attached to the movable system part and moves with it in the horizontal direction.

The upper run of the cable carrier is free, i.e. without support and without sag, parallel above the fully supported lower run.

The formulas and configuration information for this installation

variant can be found in the chapter "Determining the cable carrier length L_k for simple linear travel" on page 183.

Technical Information from page 178

Special case

Horizontal arrangement, unsupported with overhang

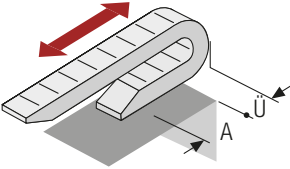

i The lower run of the cable carrier is not supported across the entire length. We are happy to calculate the required dimensions $A + \ddot{U}$ for your individual application.

Please contact us for individual project planning for your specific application. We will be happy to help.

Technical support:
Fon: +49 (0)2762 4003-0

Rule of thumb

$$\ddot{U}_{\max} \leq \frac{L_f}{4}$$



TSUBAKI KABELSCHLEPP technical support

If you have any questions about cable carriers or technical details please contact our technical support service at technik@kabelschlepp.de. We will be happy to help you.

INV 2

Horizontal arrangement with support

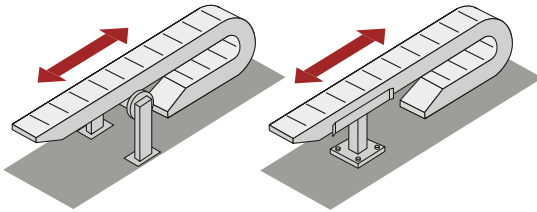

i If the unsupported length of the cable carrier is exceeded, the upper run can be supported.

We recommend using the next larger type instead of a cable carrier with support(s), if the installation situation allows this.

More information:
traxline.de

Support for the upper run is generally possible for almost all cable carriers. The support stand used for plastic cable carriers always has to be equipped with start-up levels. The upper run should be supported as far as possible.

Arrangement of the support

Due to the flexible material and the potential sag, however, there are limitations on the use of supports for plastic cable carriers. The following section therefore examines the arrangement of the support for **steel cable carriers with support rollers**:

Arrangement with one support roller:

for $L_S < 3 L_f$ $a_R = \frac{L_S}{6}$

The distance of the support from the fixed point is approx. 1/6 of the travel length!

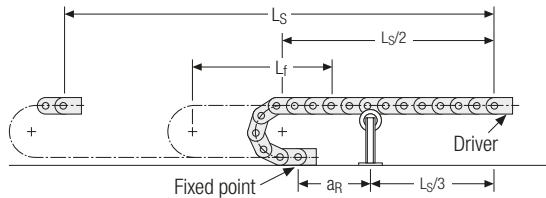

Arrangement with two support rollers:

for $L_S < 4 L_f$ $a_{R1} = 300 \text{ mm}$
 $a_{R2} = \frac{L_S}{4} - 150 \text{ mm}$

First support 300 mm behind the fixed point, second support at the center of the remaining unsupported length!

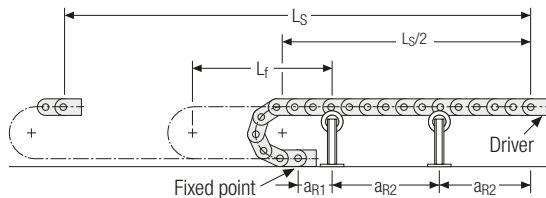

A travel speed of 1 m/s should not be exceeded. When using support rollers, the length L_f should only be 80 % of the value resulting from the load diagram, if possible.

Special version with lateral rollers:

for $L_S < 4 L_f$

To utilize the maximum possible travel length in an unsupported arrangement with stationary support structure.

The lateral track rollers are mounted on the chain links. An even running surface has to be ensured, with a support tray provided if necessary.

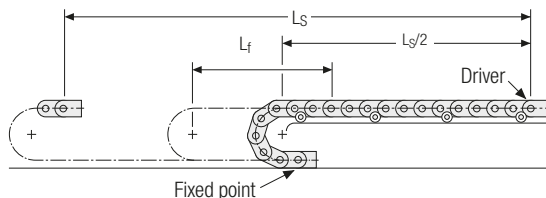

tsubaki-kabelschlepp.com

Technical support:
technik@kabelschlepp.de

INV 3

Horizontal arrangement, gliding in the guide channel

Definition from page 164

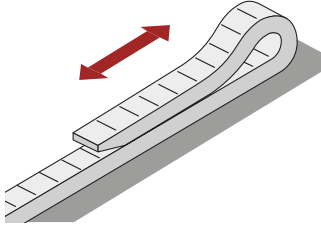

i The upper run of the cable carrier **glides** on the lower run or on a gliding surface of the associated guide channel.

Application: For long travel lengths which cannot be implemented as unsupported arrangements.

Condition: The cable carrier must be guided in a channel, though!

Technical Information from page 178

Different cable carrier types provide the option of using glide shoes on the inner radius. These are manufactured from a special sliding and wear-resistant plastic. This allows the sliding friction factor to be reduced to a value of $\mu < 0.2$.

For steel cable carriers, the use of these elements is mandatory to prevent gliding of "steel on steel". The travel speed, however, should not exceed 1 m/s for gliding steel cable carriers. For steel cable carriers, the glide shoes are bolted onto the side band.

For plastic cable carriers, the glide shoes are simply clipped on the inner radius and can therefore easily be replaced if necessary.

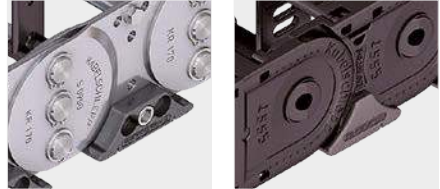

Technical support: Fon: +49 (0)2762 4003-0

To reduce wear and increase the service life, we recommend using the abrasion resistant glide shoes for gliding applications. For travel speeds > 2.5 m/s, however, glide shoes should always be used.

Arrangement of the cable carrier

Single-sided arrangement with lowered driver connection and reverse bending radius (standard)

The cable carrier length is always calculated with the same formula as for the unsupported arrangement:

Cable carrier length L_k

$$L_k \approx \frac{L_s}{2} + L_B$$

Cable carrier length L_k rounded to pitch t

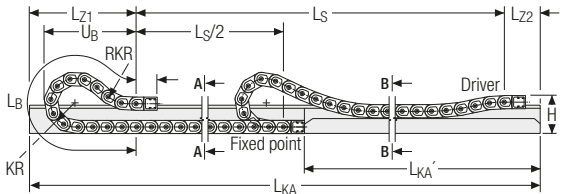

For the standard arrangement of the cable carrier, the driver connection is reduced for load reasons:

Connection height H

$$H = 3 h_G$$

The length of carrier in bend L_B is increased by the lower driver connection and the resulting cable carrier extension. To keep this elevation of the length of carrier in bend as small as possible, chain links with reverse bending radius (RKR) are used on the driver connection as a standard. This results in a slight S-shape for the bend in the thrust end position. The respective values for L_B can be found in the respective individual chapters for the cable carriers.

For the configuration of this installation variant we recommend the simple way of determining the cable carrier length using our Configurator at online-engineer.de or requesting support from our support team.

Opposite arrangement with lowered driver connection and reverse bending radius

If the cable carrier is wider than the available space due to a very large number of cables, a second cable carrier can be used, running in the opposite direction. This almost halves the total width because the cables can be distributed among both cable carriers.

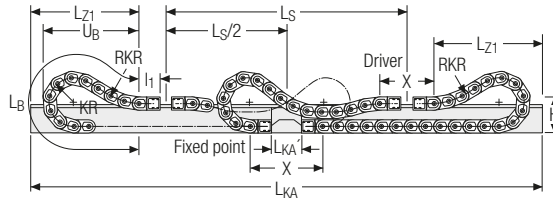

The cable carrier length is then determined in the same way as for single-sided arrangements. For only one moving consuming unit and a joint travel path, both cable carrier lengths have to be the same. As both cable carriers run in a guide channel, it must be ensured that they have the same outer width. More information and the details for dimensioning the guide channel can be found in chapter *Support trays and guide channels* of our catalog *THE COMPLETE KABELSCHLEPP*.

INV 4 Vertical arrangement, hanging

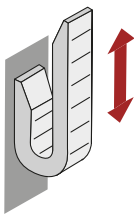

i **Direction of movement:**
only vertical

For a purely vertical movement process, the cable carrier can be mounted without special lateral support.

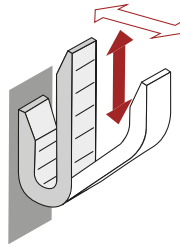

i **Direction of movement:**
vertical/horizontal combined

For a combined vertical/horizontal movement process, the cable carrier can be mounted without special lateral support.

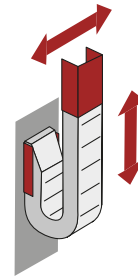

i **Direction of movement:**
only vertical

If the entire system moves at a right angle to and/or alongside the hanging cable carrier, an additional lateral guide has to be mounted.

Please observe the guidelines for placement of cables in cable carriers from TSUBAKI KABELSCHLEPP, s. page 188.

It is practical to install the cable carrier **without or with only little pretension**.

As no direct load occurs in the hanging arrangement, pretension causes the cable carrier to bulge outwards from the pretension. In addition to the visual aspect, this significantly increases the installation dimensions.

The **cables have to be fixed** to the driver and fixed point in such a way that their weight and the resulting dynamic load are absorbed only by the strain relief. Determining the cable carrier length see page 183.

More information:
traxline.de

tsubaki-kabelschlepp.com

Technical support:
technik@kabelschlepp.de

INV 5

Vertical arrangement, standing

Definition from page 164



The cable carrier is mounted in such a way that parallel running of active run and passive run is ensured.

Determining the cable carrier length see page 183.

Technical Information from page 178

End connectors

The end connectors have to be mounted on the machine part (fixed point/driver) in such a way that the cable carrier cannot bend outwards, i.e. the connection must be **rigid**.

Connection height H

$$H = 2 KR + h_G$$

The distance between fixed point and driver connection corresponds to the selected bending radius.

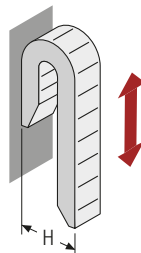

Technical support:
 Fon: +49 (0)2762 4003-0

Support

The cable carrier generally has to be supported on the outside at the fixed point and at the driver.

The length of the support has to be defined depending on the additional load, the fill level, the travel length and the selected cable carrier.

Depending on the version of the support, the cable carriers are very often used with a slight pretension. If a short cable carrier does not require any support and if there is sufficient installation space, the standard pretension can be used. Use without pretension may result in the cable carrier bending. This is therefore not advisable.

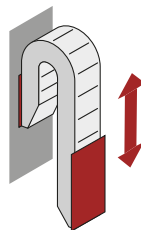

Direction of movement

Often, the complete unit additionally moves **at a right angle** to the vertical standing cable carrier. In this case, the cable carrier additionally has to be guided laterally.

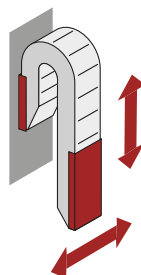

As a rule, only relatively short travel lengths can be implemented with the standing arrangement. If possible, the cable carrier should alternatively be used in a hanging arrangement. For this installation variant, the load on the overall system is significantly lower than with a standing arrangement.

INV 6

Horizontal arrangement, rotated 90° (straight)

 The cable carrier used in normal horizontal direction is rotated by 90°, i.e. it glides on its outside or on special **slide discs** on a tray or in a channel. This arrangement can be implemented with almost all cable carrier types.

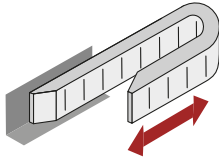

Application: Generally, cable carriers “rotated 90°” are used when the installation situation is primarily short on space with respect to height, preventing normal horizontal installation.

The installed cables have to be guided in the cross section of the cable carrier with **fixed separating elements** or in a **hole stay**, clearly separated from each other. This is the only way to prevent damage in the long run.

The technically best solution is the hole stay which provides the most secure guiding for the cables.

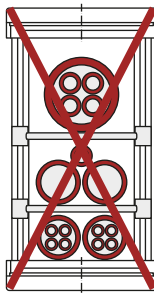

Frame stay with movable dividers

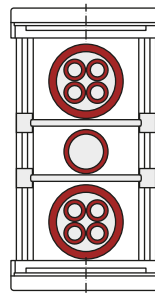

Frame stay with fixed dividers

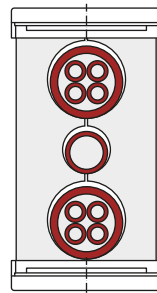

Best possible separation of cables in a hole stay

More information:
traxline.de

tsubaki-kabelschlepp.com

Systems for short travel lengths (with/without support)

The cable carriers can be used **unsupported** in the horizontal arrangement “rotated 90°” to a limited extent. The permitted unsupported length depends on the following parameters for this installation variant as well:

- additional load q_z
- bending radius KR
- connection option
- travel length L_S
- cable carrier width B_K

If the additional load and the unsupported length are too great, the cable carrier has to be supported on one side or overall.

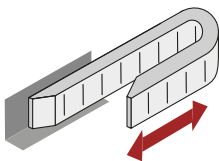

System without support

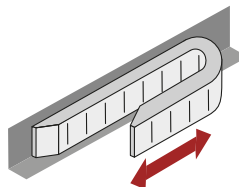

System with single-sided support

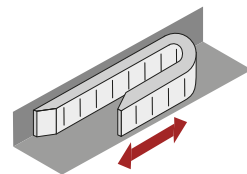

System with overall support

Technical support:
technik@kabelschlepp.de

System for long travel lengths (gliding in a guide channel)

Plastic cable carriers can be used for travel lengths far over 100 m with the arrangement "rotated 90° – straight". Over a period of more than 60 years, we have built multiple systems with the arrangement "single-sided" or "opposite" with or without special auxiliary fixtures.

Single-sided arrangement (with stepped guide channel)

b_{KA} = channel width of narrow section
 l_{KA} = length of narrowed channel

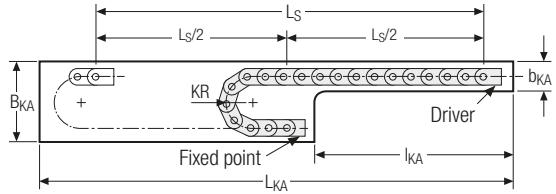

Opposite arrangement

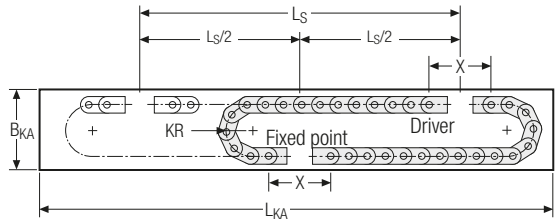

The cable carrier "rotated 90°" for long travel lengths **must** be guided in a channel. The material and texture of the channel base must be selected so they ensure low-wear travel with the lowest possible friction forces.

For long travel lengths, the cable carriers are used without pretension.

For **steel cable carriers**, corresponding gliding and guiding elements are mounted on the outside and/or inside of the side band, preventing grinding along the channel walls and ensuring smooth running of the system.

Support and guiding elements (combination examples):

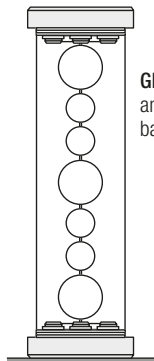

Gliders on upper and lower side band

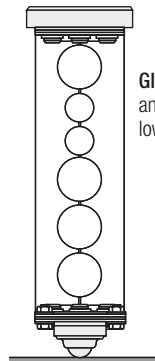

Gliders on the top and domes on the lower side band

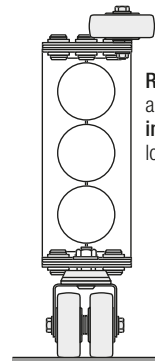

Rollers on the top and double steering rollers on the lower side band

INV 7

Horizontal arrangement, rotated 90° (circular)

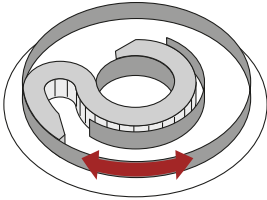

i For this arrangement, the cable carrier rotated 90° is connected to machine parts which carry out a circular movement.

The combination of bending radius KR and reverse bending radius RKR causes the cable carrier to move in two circular directions in a targeted and defined manner.

The cable carrier system is connected to the inner and outer rings of a guide channel. The rotating ring (inside or outside) is the driver connection.

Application: Generally, cable carriers in this arrangement always have to be guided in a channel. The driver can be positioned inside or outside.

A special chain link design is required to allow the cable carrier to execute a circular movement.

The installed cables have to be guided in the cross section of the cable carrier with **fixed separating elements** or in a **hole stay**, clearly separated from each other. This is the only way to prevent damage in the long run.

The technically best solution is the hole stay which provides the most secure guiding for the cables.

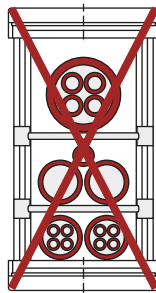

Frame stay with movable dividers

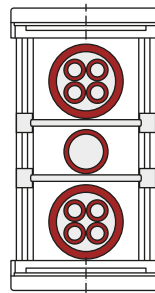

Frame stay with fixed dividers

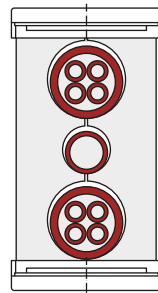

Best possible separation of cables in a hole stay

Due to the strong relative displacement and the continuously changing radius ratios, cables should only be installed in one layer to ensure maximum service life.

For **steel cable carriers**, corresponding gliding and guiding elements are mounted on the outside and/or inside of the side band, preventing grinding along the channel walls and ensuring smooth running of the system (see page 200).

More information:
traxline.de

tsubaki-kabelschlepp.com

Technical support:
technik@kabelschlepp.de



TSUBAKI KABELSCHLEPP technical support

If you have any questions about cable carriers or technical details please contact our technical support service at technik@kabelschlepp.de. We will be happy to help you.

Single-sided arrangement with offset guide channel (schematic diagram)

The cable carrier system shown here has the driver on the inner radius. There are also frequent applications where the driver has to be positioned on the outer radius.

To ensure sufficient guiding of the cable carrier in this case, moving guide plates are required for larger angles of rotation. As this version is more complex, the "inside rotating circular arrangement" should be preferred.

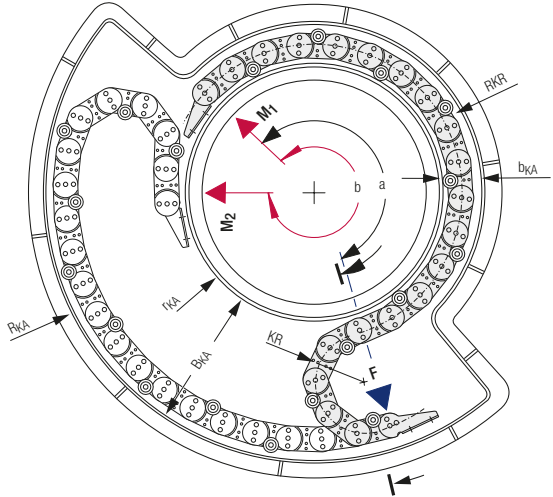

Opposite arrangement with guide carriage (schematic diagram)

For opposite arrangements, a moving support fixture or a guide carriage has to be positioned in the channel due to the combination of KR and RKR.

Coupling of multiple circular systems is possible for angles of rotation over 500°.

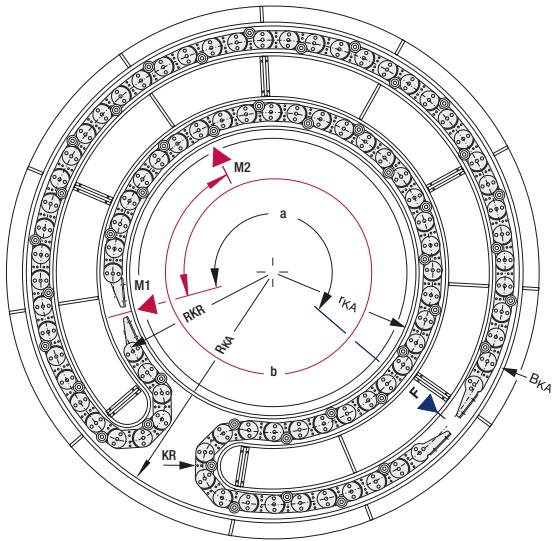

Abbreviated symbols:

α	= fixed point angle
β	= travel length
B_E	= width of cable carrier
b_{KA}	= channel width of narrow section
B_{KA}	= channel width
H_E	= height of cable carrier
H_{KA}	= height of the guide channel
r_{KA}	= channel radius - inside
R_{KA}	= channel radius - outside
F	= fixed point
M_1	= driver end position 1
M_2	= driver end position 2

Due to the variety of configuration options for this installation variant, we recommend contacting our technical support. We require the following parameters for preparing a solution:

- inner diameter
- outer diameter
- travel length (angle of rotation)
- single-sided or opposite arrangement?
- driver on inner or outer radius? (inner radius preferred for single-sided arrangement)
- restrictions for the installation space? (e.g. installation height)
- cable list
- environmental conditions (e.g. chips, dirt)

INV 8

Horizontal arrangement, rotated 90° (rolled)

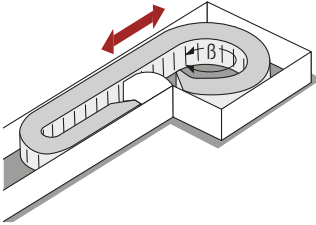

i For this arrangement, the cable carrier rotated 90° is connected to a consuming unit which carries out a circular movement. The travel length “β” is indicated in degrees!

Application: The application is designed for circular movements which are wound on a rotating body. This type of cable carrier is preferred for smaller systems, usually with large movement angles.

A standard cable carrier is used. A reverse bending radius is not required. The winding of the carrier limits the angle of rotation to approx. $\beta = 270^\circ$. For the implementation of larger angles of rotation, additional guide plates are required to prevent a collision on the driver. This application is practically a combination of installation variants 6 and 7. Accordingly, similar configuration criteria are used.

More information:
traxline.de

tsubaki-kabelschlepp.com

INV 9

Horizontal-vertical combined arrangement

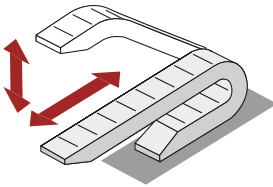

i Our cable carriers can also be used for combined horizontal/vertical movements.

This arrangement requires no special technical preconditions, but calculation of the cable carrier length is more complex and should be carried out by our technical support.

INV 10

Unsupported arrangement, nested

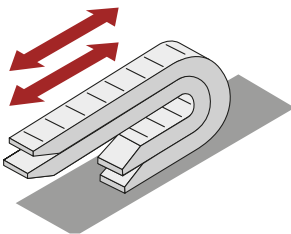

i This arrangement is possible for all cable carriers. If the available space do not permit installation of a cable carrier due to the required width, the system can be configured in a **nested** arrangement.

For smooth running, it has to be ensured that both cable carriers can move freely. This means sufficient distance between the upper run (min. 20 mm, depending on cable carrier type) and the carrier bends (min. half of chain link height).

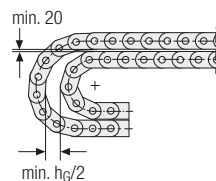

For long steel cable carriers there is an option for positioning guide plates at the side band of the outer carrier to ensure alignment of the inner carrier.

Technical support:
technik@kabelschlepp.de

INV 11 Zig-zag arrangement

Definition from page 164

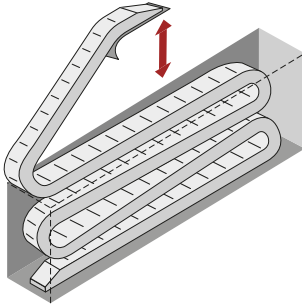

i For some areas of application (e.g. stage and storage systems), it is often not possible to use a vertical hanging or standing cable carrier due to space restrictions. The so-called zig-zag arrangement is used in these cases.

As several bends fold on top of one another, the cable carrier has to be guided in all directions and therefore settles into a type of basket or sheet steel housing.

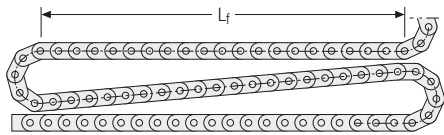

Technical Information from page 178

The following parameters are required for dimensioning the system:

- travel length
- travel speed
- cables installed
- minimum bending radius of guided cables
- maximum permitted height
- maximum permitted basket dimensions (length, width)

When dimensioning the basket length, ensure that the unsupported length L_f of the selected cable carrier is not exceeded. Depending on the length and weight of the cable carrier, supporting the bend on the driver with a bent plate is a measure which has a positive effect on the service life.

Technical support:
Fon: +49 (0)2762 4003-0

INV 12 Vertical arrangement, hanging with support bolt

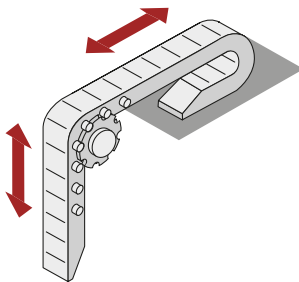

i The vertical arrangement of the cable carrier with additional support elements offers the option of using the cable carrier as a lifting element for the attached system parts (e.g. operating panels, manipulators).

The cable carrier is driven via chain wheels. The pitch circle diameter has to be equal to or greater than the selected bending radius of the cable carrier. The drive is motorized or via a counterweight.

Due to the great number of configuration aspects, we would ask you to contact our technical support.

INV 13

Horizontal arrangement, curled

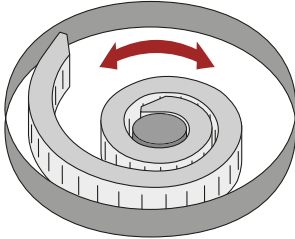

i In some cases, a large angle of rotation cannot be implemented with one of the usual applications for circular movements. In these cases, an examination with regard to the options for curling up the cable carrier is recommended.

A standard cable carrier can be used, but a relatively large installation space is required for curling up the configuration.

The rotation in this application is limited by a maximum double wrapping of the inner diameter. Multiple wrappings cause the cable carrier to jam.

More information:
traxline.de

INV 14

Vertically rotating arrangement, hanging

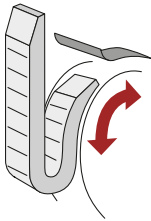

i This installation variant is often used for swiveled drums and turning devices.

The part rotating around the diameter requires chain links with KR and RKR in this area.

If the angle of rotation is over 180° (depending on the arrangement), an additional guide plate is required on the outer radius to prevent the cable carrier from tipping over.

tsubaki-kabelschlepp.com

INV 15

Roller chain

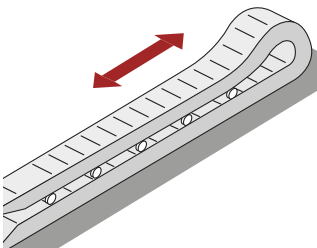

i Roller chains are primarily used where very long travel lengths lead to very high push and pull forces and gliding cable carriers reach their limits. The most effective installation variant is the RSC (rail supported carrier) system. This is a cable carrier where the design in combination with an optimized guide channel ensures 100 % roller operation over the entire travel length. This results in minimum mechanical load and a low noise level.

This makes the system suitable not only for extremely long travel lengths, but also for travel speeds over 5 m/s.

Technical support:
technik@kabelschlepp.de

Despite the roller design, the RSC system can be fully wound on a reel and is therefore ideal for complete solutions with inserted cables for long travel lengths.

Dimensioning is similarly easy as for a gliding cable carrier. For effective and fast implementation, especially for large projects, we can offer our expert help.

INV 16

Arrangement with continuous support structure

Definition from page 164

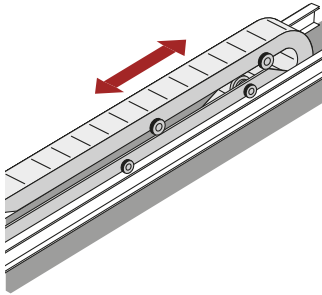

While this installation variant is also possible for plastic cable carriers, it is primarily used for steel cable carriers.

If the technical conditions no longer permit the use of a gliding cable carrier or a cable carrier with support rollers with regard to travel length, acceleration or speed, a so-called cable carrier unit with a continuous moving support structure can be used.

Technical Information from page 178

Cable carrier units are particularly suitable for use with large travel lengths and high travel speeds under rough operating conditions and heavy loads. There is a variety of different versions of this installation variant. As an example, we present the most used type 225 here.

Due to the complexity, this type of cable carrier system should be dimensioned in cooperation with our engineers.

Cable carrier installation type 225

The cable carrier installation is either configured as a single-sided system with one cable carrier installation or as an opposite arrangement with two cable carriers.

A carriage guided on rollers in a running frame supports the cable carriers along their entire length. The support structure is moved in both directions with a cable pull system which is attached to the rolling carriage system. Due to the roller support and roller guiding of the cable carriers

on the support carriage and of the support carriage on the running frame, only minimal friction forces are generated in the system. Systems with the following limit values have been supplied so far:

- longest travel length: $L_{S \max.} = 222 \text{ m}$
- highest travel speed: $v_{\max} = 4 \text{ m/s}$
- greatest travel acceleration: $a_{\max} = 8 \text{ m/s}^2$

Technical support:
Fon: +49 (0)2762 4003-0

Single-sided arrangement (schematic diagram)

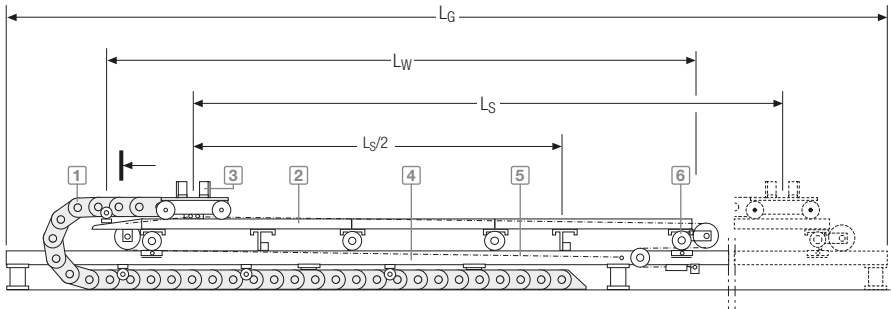

Opposite arrangement (schematic diagram)

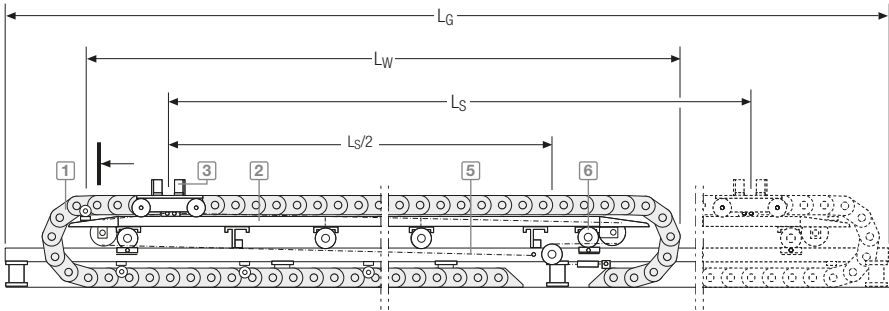

More information:
traxline.de

Cross section of the cable carrier installation

Abbreviated symbols:

B_D	= clear width in the running frame
B_G	= running frame width
B_k	= cable carrier width
B_W	= support carriage width (max. width)
H	= installation height of the cable carrier(s)
H_G	= running frame height
L_G	= running frame length
L_S	= travel length
L_W	= support carriage length

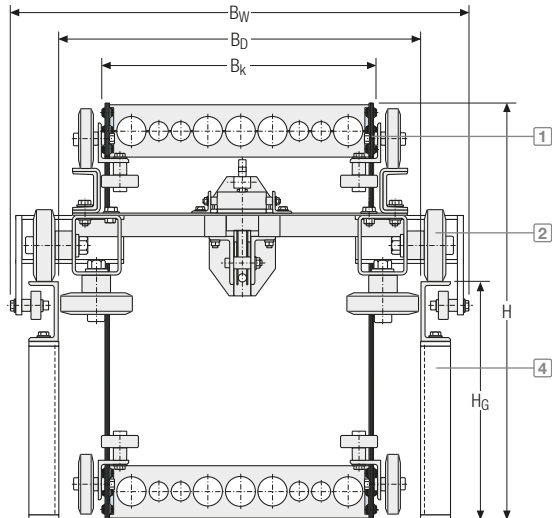

tsubaki-kabelschlepp.com

Technical support:
technik@kabelschlepp.de

The cable carrier installation type 225 consists of the following assemblies:

- 1 **Cable carrier(s)**
with laterally attached track rollers and guide rollers
- 2 **Support carriage** with track rollers and guide rollers supporting across the entire length
- 3 **Rolling carriage system** with track rollers and guide rollers
- 4 **Running frame**
- 5 **Steel cable**
- 6 **Cable tensioning roller**
- 7 **Tensioning device**

Strain relief devices

For optimum placement
with dynamic use of cables



Trademarks are legally protected for the TSUBAKI
KABELSCHLEPP GmbH as a national or international
registration in the following countries:
tsubaki-kabelschlepp.com/ trademarks

Subject to change.

Strain relief devices

KABELSCHLEPP® strain reliefs were developed especially for use in cable carriers. We offer the best solution for each of many different areas of application. The type of

strain relief to be selected depends on cable type, length of the cable carrier and installation position.

More information:
traxline.de



LineFix® clamps page 210

- Optimized foot geometry for secure seating in the C-rail.
- For one cable and two or three cables stacked.
- For C-rails with 11 mm slot width.



Strain relief combs page 214

- Higher fixing force than single-sided strain relief comb.
- Uniform force transmission in push and pull direction.



SZL strain reliefs page 216

- Gentle on the cables through large contact area with the cables.
- Simple mounting without tools.



Block clamps page 217

- For strain relief of hoses.

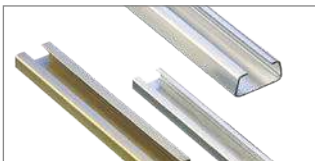

Assembly profiles page 218

- Assembly profiles for strain relief elements

tsubaki-kabelschlepp.com

Technical support:
technik@kabelschlepp.de

LineFix clamps | Overview

- For C-rails with 11 mm slot width.
- For one, two or three cables stacked.
- Optimized foot geometry for secure seating in the C-profile.
- High grade corrosion protection of the coated housing body through cathodic dip coating (CDC).
- Pan design with support ribs for secure fixing of the cables.
- Rounded design of the pan elements, gentle on the cables.
- Also available in **stainless steel (ER 1S)**.

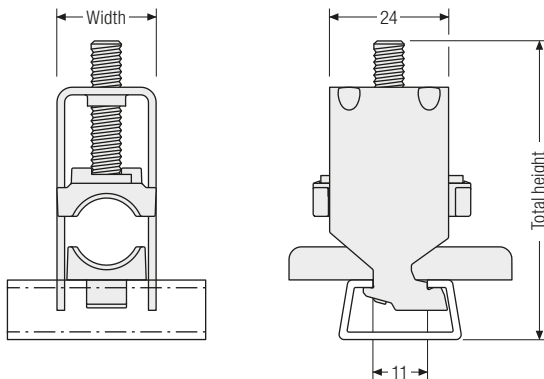

i The data for the total height are guide values. The actual height depends on the cable diameter and the cable structure, among other things.

Pan design with optimized geometry.

The curved support ribs fix the cables very gently and reliably.



Secure seating and easy assembly

In practical operation, tensile forces occur in both cable directions. Clamps therefore have to transmit high tensile forces in the respective direction.

In contrast to standard commercial clamps, the LineFix® foot geometry ensures transmission of extremely high tensile forces equally in both directions. The catch fixes the foot securely in the C-profile when it is bolted on, preventing the crossbar from tipping out during load application, regardless of the direction of forces or installation.

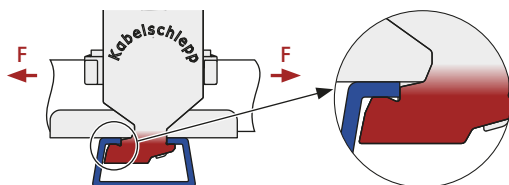

Easy installation even in tight packaging spaces through headless screw with hexagon socket.



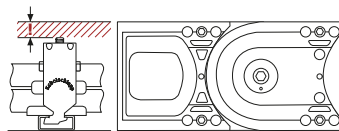

Observe minimum height

For cable carriers with upper run gliding on the lower run, the system height of the strain relief must not be higher than the chain link height!



Dimensions

Type	Designation	Material no. for one complete LineFix®	Material no. for one complete stainless steel Line-Fix® (ER 1S)	min. cable diam. [mm]	max. cable diam. [mm]	No. of cables	Width [mm]	Total height with max. cable diam. incl. C-rail* [mm]
Single clamp								
	LF 12-1	13630	13731	6	12	1	16	55
	LF 14-1	13631	13732	12	14	1	18	52
	LF 16-1	13632	13733	14	16	1	20	54
	LF 18-1	13633	13734	16	18	1	22	56
	LF 20-1	13634	13735	18	20	1	24	59
	LF 22-1	13635	13736	20	22	1	26	61
	LF 26-1	13636	13737	22	26	1	30	70
	LF 30-1	13637	13738	26	30	1	34	74
	LF 34-1	13638	13739	30	34	1	38	78
	LF 38-1	13639	13740	34	38	1	42	82
LF 42-1	13640	13741	38	42	1	46	91	
Double clamp								
	LF 12-2	13641	13742	6	12	2	16	73
	LF 14-2	13642	13743	12	14	2	18	74
	LF 16-2	13643	13744	14	16	2	20	82
	LF 18-2	13644	13745	16	18	2	22	86
	LF 20-2	13645	13746	18	20	2	24	91
	LF 22-2	13646	13747	20	22	2	26	95
	LF 26-2	13647	13748	22	26	2	30	108
	LF 30-2	13648	13749	26	30	2	34	121
	LF 34-2	13649	13750	30	34	2	38	129
	Triple clamp							
	LF 12-3	13650	13751	6	12	3	16	98
	LF 14-3	13651	13752	12	14	3	18	98
	LF 16-3	13652	13753	14	16	3	20	105
	LF 18-3	13653	13754	16	18	3	22	111
	LF 20-3	13654	13755	18	20	3	24	118
	LF 22-3	13655	13756	20	22	3	26	130

* Item no. 3934



Additional sizes on request.



Recommended tightening torque:
max. 3 Nm for electric cables suitable for cable carriers

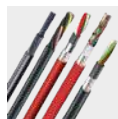

TRAXLINE® cables for cable carriers

Hi-flex electric cables which were especially developed, optimized and tested for use in cable carriers can be found at traxline.de

More information:
traxline.de

tsubaki-kabelschlepp.com

Technical support:
technik@kabelschlepp.de

LineFix clamps | Technical data

Maximum flexibility thanks to combinable double jaws

The standard sets of LineFix® clamps in size LF/LFX 12 offer even more flexibility and mounting options due to the extension with the new double and counter jaws. Optimized for different cable diameters and individually combinable heights, almost all requirements can be implemented without any problems.

Definition
from page 164

Combination possibilities

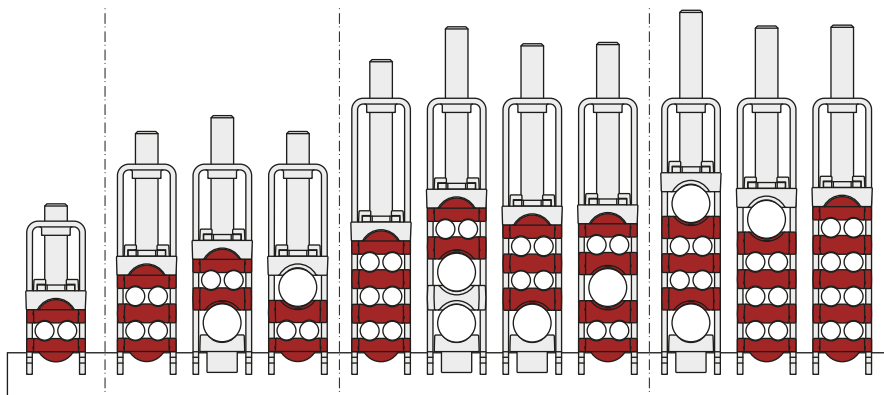

Single clamp
LF/LFX 12-1

Double clamp
LF/LFX 12-2



Triple clamp
LF/LFX 12-3

Triple clamp
LF/LFX 12-4

Technical Information
from page 178

Technical support:
Fon: +49 (0)2762 4003-0

Dimensions

Type	Designation	Material no.	min. cable diam [mm]	max. cable diam [mm]
	Double jaw LD12 d6s12	13562	3/6	6/12
	Double jaw LD12 d6d6	13563	3	6
	Counter jaw LG12 d6	13564	3	6



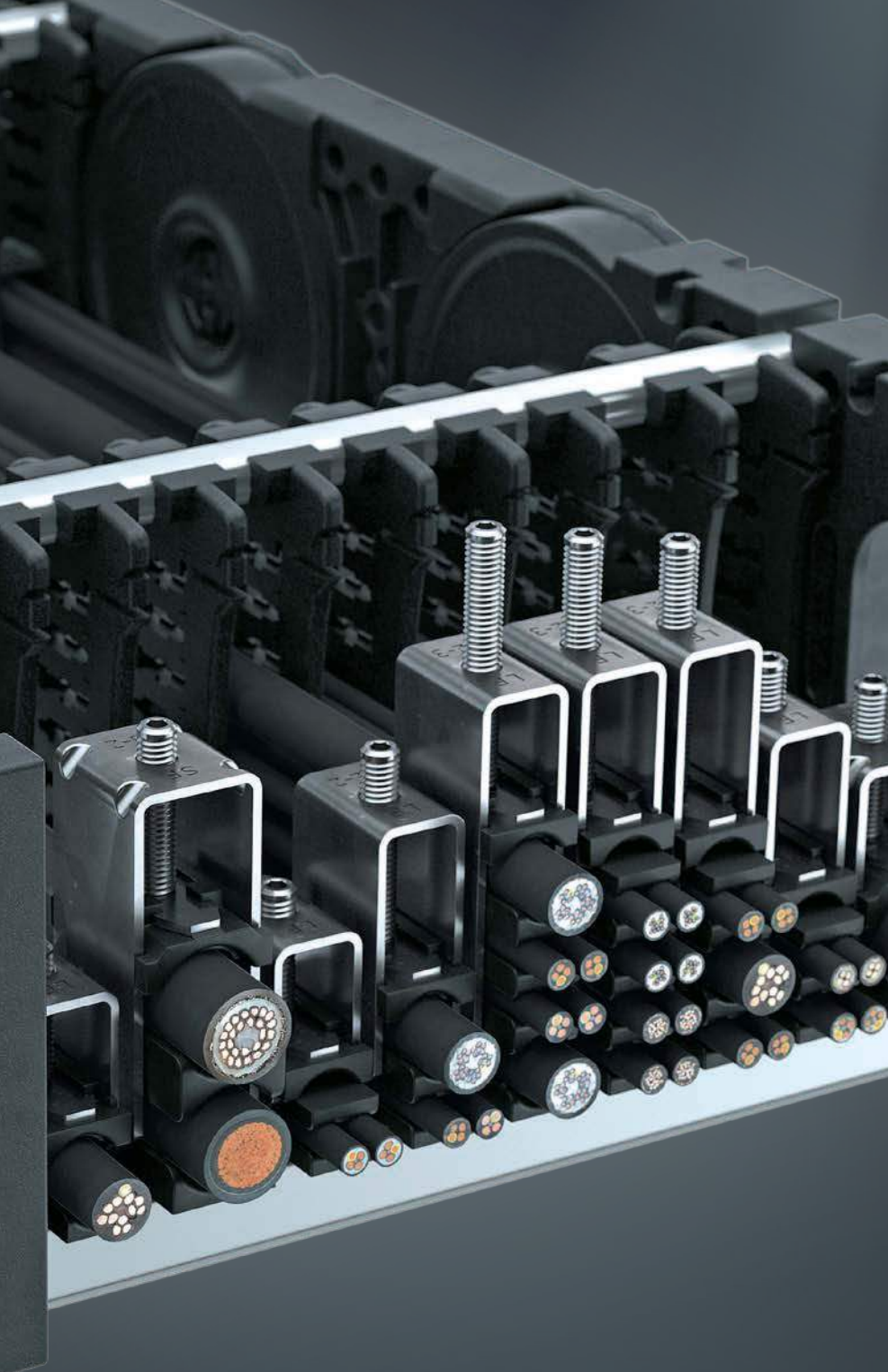

Strain relief
devices

More information:
traxline.de

tsubaki-kabelschlepp.com

Technical support:
technik@kabelschlepp.de

Strain relief combs | Technical data

For separate strain relief or fastening of cables outside of the cable carrier – suitable for all cable carriers.

The strain relief combs are equipped with teeth on both sides. This allows secure fixing of each cable with two cable ties.

- Secure fixing with two or four cable ties
- Higher fixing force than single-sided strain relief combs
- Uniform force transmission in push and pull direction
- Minimized movement of cables and hoses



Strain relief comb with C-profile connections

Mat. no.	b ₁ [mm]	b ₄ [mm]	No. of teeth
53654	49	21	2 x 3
53655	74	46	2 x 5
53656	99	71	2 x 7
53657	124	96	2 x 9
53658	149	121	2 x 11
53659	174	146	2 x 13
76550	54	21	2 x 3
76551	79	46	2 x 5
76552	104	71	2 x 7
76553	129	96	2 x 9
76554	154	121	2 x 11
76555	179	146	2 x 13

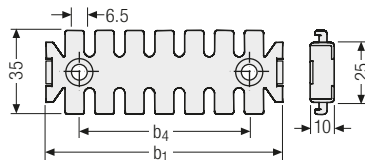

Strain relief comb

Mat. no.	b ₁ [mm]	b ₂ [mm]	b ₃ [mm]	No. of teeth
53983	50	53	14	2 x 3
53684	65	53	14	2 x 4
57350	70	70	20	2 x 4

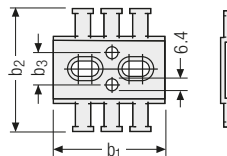

Mat. no.	b ₁ [mm]	b ₂ [mm]	b ₄ [mm]	No. of teeth
53984	70	53	15	2 x 4
53985	90	53	35	2 x 6
53986	115	53	60	2 x 8
53987	142	53	87	2 x 10
53685	90	53	25	2 x 6
53686	115	53	50	2 x 8
53687	140	53	75	2 x 10
53688	165	53	100	2 x 12
57351	95	70	20	2 x 6
57352	120	70	40	2 x 8
57354	145	70	65	2 x 10
57355	170	70	90	2 x 12
57356	195	70	115	2 x 14
57357	220	70	140	2 x 16
57358	245	70	165	2 x 18
57359	270	70	190	2 x 20

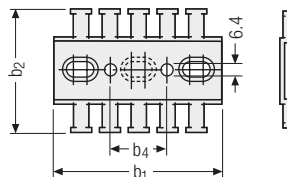



**Strain relief
devices**

More information:
traxline.de

tsubaki-kabelschlepp.com

Technical support:
technik@kabelschlepp.de

SZL strain reliefs | Overview

Definition from page 164

- Cost-effective
- Assembly – easy, fast and without tools
- Large-area surrounding of the cables
- Low height
- Without screws and cable ties
- Contact force defined by spring tension bracket
- Suitable for standard commercial profile rails
- Protected against vibrations
- Long service life for dynamic applications
- Also usable as strain relief in control cabinets



Technical Information from page 178

Available sizes

Type	Mat. no.	for cable Ø [mm]	Width B at		Height H [mm]
			Ø min [mm]	Ø max [mm]	
SZL 8	24989	> 5.0 - 8.0	16	16	28
SZL 10	24990	> 8.0 - 10.5	20	20	30
SZL 14	24991	> 10.5 - 14.5	23	26	35
SZL 18	24992	> 14.5 - 18.0	25	32	40
SZL 22	24993	> 18.0 - 22.0	30	36	44
SZL 27	24994	> 22.0 - 27.0	34	39	50
SZL 32	24995	> 27.0 - 32.0	39	44	56

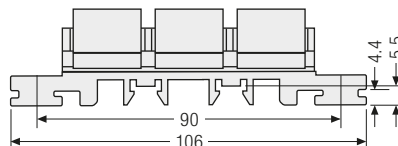
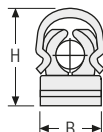

Technical support: Fon: +49 (0)2762 4003-0

Fixing options



1. Clipped into a C-rail



2. Clipped onto a DIN rail



3. Inserted into two C-rails



4. Directly bolted on C-rails

Installation of the SZL strain relief



Block clamps | Overview

- For strain relief of hoses
- With clamping screw(s) and support rail nut



Strain relief devices

More information: traxline.de

Type BS 0

Type	for cable diam. [mm]	Height H _{Sch} [mm]	Width B _{Sch} [mm]	Screws M6 - DIN 6912		Mat. no.
				Quantity	Length	
BS 0.06	6.0	27	28	1	35	16701
BS 0.07	6.4	27	28	1	35	16702
BS 0.08	8.0	27	28	1	35	16703
BS 0.09	9.5	27	28	1	35	16704
BS 0.10	10.0	27	28	1	35	16705

Other sizes and versions on request!

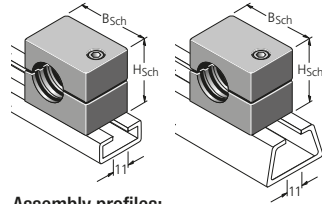

Assembly profiles:

Material: steel
Article no.: 3931

Material: steel
Article no.: 3934

tsubaki-kabelschlepp.com

Type BS 1 – BS 5

Type	for cable diam. [mm]	Height H _{Sch} [mm]	Width B _{Sch} [mm]	Screws M6 - DIN 6912		Mat. no.
				Quantity	Length	
BS 1.06	6.0	27	37	2	35	16706
BS 1.07	6.4	27	37	2	35	16707
BS 1.08	8.0	27	37	2	35	16708
BS 1.09	9.5	27	37	2	35	16709
BS 1.10	10.0	27	37	2	35	16710
BS 1.12	12.0	27	37	2	35	16711
BS 2.14	14.0	33	42	2	40	16712
BS 2.16	16.0	33	42	2	40	16713
BS 2.18	18.0	33	42	2	40	16714
BS 3.20	20.0	35.5	50	2	45	16715
BS 3.22	21.3	35.5	50	2	45	16716
BS 3.23	25.0	35.5	50	2	45	16717
BS 3.25	25.4	35.5	50	2	45	16718
BS 3.27	26.9	41.5	59	2	45	16719
BS 3.30	30.0	41.5	59	2	45	16721
BS 4.32	32.0	41.5	59	2	65	16722
BS 4.34	33.7	56.5	71	2	65	16723
BS 4.35	35.0	56.5	71	2	65	16724
BS 4.38	38.0	56.5	71	2	65	16725
BS 4.40	40.0	56.5	71	2	65	16726
BS 4.42	42.0	56.5	71	2	65	16727
BS 5.45	44.5	64.5	86	2	75	16728
BS 5.48	48.3	64.5	86	2	75	16729
BS 5.51	50.8	64.5	86	2	75	16731

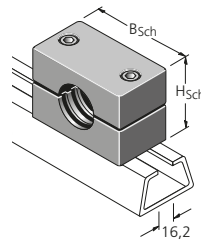

Assembly profiles:

Material: steel
Article no.: 3932

Technical support: technik@kabelschlepp.de

Subject to change.

Assembly profiles for strain reliefs | Overview

- Assembly profiles for strain relief elements – for all commercially available clamps
- Length in 1 mm grid available



Definition
from page 164

Technical Information
from page 178

Technical support:
Fon: +49 (0)2762 4003-0

online-engineer.de
Cable Carrier Configurator

C-profile 25 x 10 mm

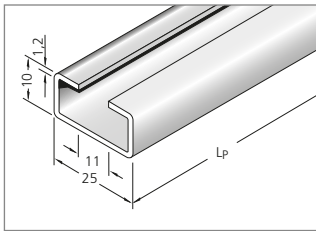

Suitable for all LineFix® clamps
(slot width 11 mm),
LineFix types see page 210.

Material	Article no.
Galvanized steel	3931
Attach profile with cheese-head screws M6 – DIN 6912	

C-rail 25 x 12 mm

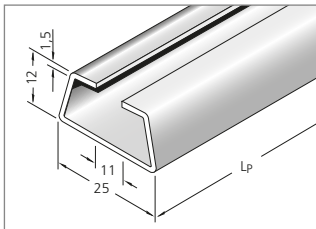

Suitable for all LineFix® clamps
(slot width 11 mm),
LineFix types see page 210.

Material	Article no.
Galvanized steel	3934
Attach profile with cheese-head screws M6 – DIN 6912	

C-rail 34 x 15 mm

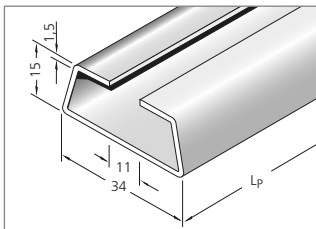

Suitable for all LineFix® clamps
(slot width 11 mm),
LineFix types see page 210.

Material	Article no.
Galvanized steel	3935
Stainless steel (ER 1S)	3936
Attach profile with cheese-head screws M6 – DIN 6912	

Assembly profiles for strain reliefs | Overview

C-profile 34 x 15 mm

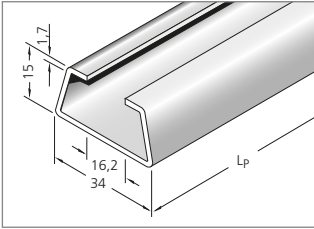

Suitable for all standard clamps
(slot width 16 – 17 mm)

Material **Article no.**
Steel 3932

Attach profile with cheese-head screws M10 – DIN 6912

 The selection of the suitable C-rail depends on the connecting element.

More information:
traxline.de

tsubaki-kabelschlepp.com

Technical support:
technik@kabelschlepp.de

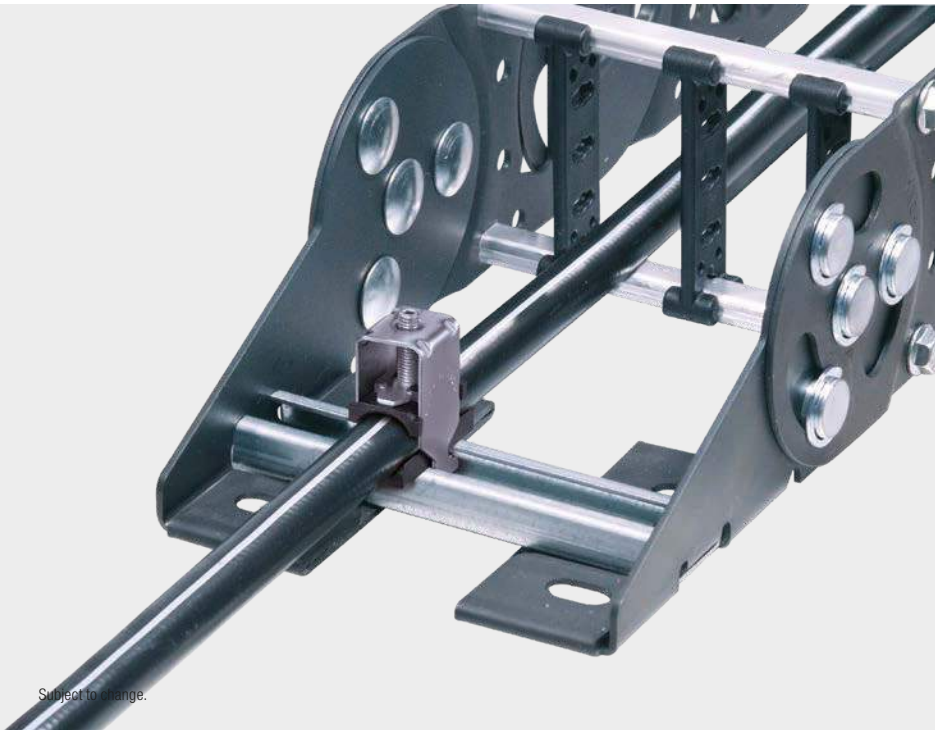

Overview as per part numbers

Art.-No.	page	Art.-No.	page	Art.-No.	page	Art.-No.	page	Art.-No.	page
45201.....	39	45442.....	29	45587.....	51	45695.....	111	45817.....	53
45202.....	39	45443.....	29	45588.....	51	45696.....	115	45818.....	53
45203.....	39	45445.....	29	45589.....	51	45697.....	115	45819.....	53
45205.....	39	45446.....	29	45590.....	51	45698.....	115	45820.....	53
45209.....	39	45449.....	29	45591.....	51	45699.....	115	45821.....	53
45211.....	39	45451.....	29	45592.....	51	45701.....	31	45822.....	53
45213.....	39	45454.....	29	45593.....	51	45702.....	31	45823.....	53
45214.....	39	45501.....	43	45594.....	51	45703.....	31	45824.....	53
45221.....	39	45502.....	43	45595.....	51	45705.....	31	45825.....	53
45222.....	39	45503.....	43	45596.....	51	45709.....	31	45826.....	53
45223.....	39	45505.....	43	45597.....	51	45712.....	31	45827.....	53
45225.....	39	45509.....	43	45598.....	51	45715.....	31	45828.....	53
45229.....	39	45511.....	43	45622.....	75	45721.....	31	45829.....	53
45231.....	39	45514.....	43	45623.....	75	45722.....	31	46090.....	123
45234.....	39	45516.....	43	45624.....	75	45723.....	31	46100.....	123
45242.....	39	45521.....	43	45625.....	75	45725.....	31	46104.....	123
45243.....	39	45522.....	43	45626.....	75	45729.....	31	46105.....	123
45245.....	39	45523.....	43	45627.....	75	45732.....	31	46110.....	125
45252.....	39	45525.....	43	45628.....	75	45735.....	31	46115.....	125
45253.....	39	45529.....	43	45629.....	75	45741.....	31	46120.....	125
45254.....	39	45531.....	43	45630.....	75	45742.....	31	46125.....	123
45262.....	39	45534.....	43	45632.....	75	45743.....	31	46130.....	123
45263.....	39	45536.....	43	45634.....	75	45745.....	31	46135.....	123
45272.....	39	45541.....	43	45635.....	75	45749.....	31	46150.....	121
45273.....	39	45542.....	43	45636.....	75	45752.....	31	46155.....	121
45282.....	39	45543.....	43	45637.....	75	45755.....	31	46160.....	121
45292.....	39	45544.....	43	45638.....	75	45757.....	31	46165.....	121
45302.....	39	45546.....	43	45639.....	75	45759.....	31	46170.....	121
45312.....	39	45549.....	43	45640.....	75	45760.....	45	46175.....	121
45355.....	73	45551.....	43	45641.....	75	45761.....	45	46200.....	119
45356.....	73	45552.....	43	45642.....	75	45762.....	45	46205.....	119
45357.....	73	45553.....	43	45643.....	75	45763.....	45	46210.....	119
45358.....	73	45555.....	43	45646.....	75	45765.....	45	46215.....	119
45359.....	73	45559.....	43	45647.....	75	45769.....	45	46220.....	119
45360.....	73	45560.....	43	45649.....	75	45772.....	45	46225.....	119
45361.....	73	45561.....	43	45650.....	75	45775.....	45	46230.....	119
45372.....	73	45562.....	43	45651.....	75	45777.....	45	46235.....	119
45373.....	73	45563.....	43	45652.....	75	45778.....	45	46240.....	119
45374.....	73	45564.....	43	45654.....	75	45780.....	45	46250.....	121
45376.....	73	45565.....	43	45661.....	77	45781.....	45	46255.....	121
45377.....	73	45566.....	43	45662.....	77	45783.....	45	46260.....	121
45380.....	73	45567.....	43	45664.....	77	45785.....	45	46300.....	121
45382.....	73	45568.....	43	45665.....	77	45787.....	45	46305.....	121
45391.....	29	45569.....	43	45667.....	79	45789.....	45	46315.....	121
45392.....	29	45570.....	43	45669.....	79	45790.....	45	46323.....	121
45393.....	29	45571.....	43	45670.....	91	45791.....	45	46330.....	121
45396.....	29	45572.....	43	45672.....	91	45801.....	45	46345.....	121
45400.....	29	45573.....	43	45679.....	79	45802.....	45	46350.....	121
45401.....	29	45574.....	43	45680.....	105	45803.....	45	46355.....	121
45402.....	29	45575.....	51	45683.....	109	45804.....	45	46360.....	121
45412.....	29	45576.....	51	45684.....	101	45805.....	45	46365.....	121
45415.....	29	45577.....	51	45685.....	109	45806.....	45	46400.....	123
45421.....	29	45578.....	51	45686.....	93	45807.....	45	46410.....	123
45422.....	29	45579.....	51	45687.....	95	45808.....	45	46412.....	125
45423.....	29	45580.....	51	45688.....	97	45809.....	45	46415.....	125
45425.....	29	45581.....	51	45689.....	87	45810.....	45	46505.....	123
45429.....	29	45582.....	51	45690.....	85	45811.....	45	47202.....	41
45431.....	29	45583.....	51	45691.....	107	45812.....	45	47222.....	41
45434.....	29	45584.....	51	45692.....	89	45814.....	53	47223.....	41
45436.....	29	45585.....	51	45693.....	99	45815.....	53	47225.....	41
45441.....	29	45586.....	51	45694.....	111	45816.....	53	47242.....	41

Definition
from page 164Technical Information
from page 178Technical support:
Fon: +49 (0)2762 4003-0

Overview as per part numbers

Art.-No.	page	Art.-No.	page	Art.-No.	page	Art.-No.	page	Art.-No.	page
47243.....	41	47672.....	23	48113.....	25	49590.....	57	49821.....	63
47245.....	41	47673.....	23	48115.....	25	49591.....	57	49822.....	63
47252.....	41	47674.....	23	48119.....	25	49592.....	57	49823.....	63
47253.....	41	47676.....	23	48121.....	25	49593.....	57	49824.....	63
47262.....	41	47680.....	23	48124.....	25	49594.....	57	49825.....	63
47263.....	41	47684.....	23	48125.....	25	49595.....	57	49826.....	59
47272.....	41	47687.....	23	48126.....	25	49622.....	81	49827.....	63
47273.....	41	47692.....	23	48128.....	25	49623.....	81	49828.....	63
47282.....	41	47693.....	23	48623.....	71	49624.....	81	49829.....	63
47292.....	41	47694.....	23	48627.....	71	49625.....	81	49837.....	65
47352.....	21	47696.....	23	48638.....	71	49626.....	81	49838.....	65
47353.....	21	47700.....	23	48647.....	71	49627.....	81	49839.....	65
47354.....	21	47704.....	23	48648.....	71	49628.....	81	49840.....	65
47356.....	21	47707.....	23	48649.....	71	49629.....	81	49841.....	65
47360.....	21	47712.....	23	48664.....	27	49630.....	81	49842.....	65
47364.....	21	47713.....	23	48666.....	27	49632.....	81	49843.....	65
47367.....	21	47714.....	23	48668.....	27	49634.....	81	49844.....	65
47372.....	21	47716.....	23	48670.....	27	49635.....	81	49845.....	65
47373.....	21	47720.....	23	48674.....	27	49636.....	81	49846.....	65
47374.....	21	47724.....	23	48678.....	27	49637.....	81	49847.....	65
47376.....	21	47727.....	23	48679.....	27	49638.....	81	49848.....	65
47380.....	21	48040.....	25	48680.....	27	49639.....	81	49849.....	65
47384.....	21	48041.....	25	48682.....	27	49640.....	81	49857.....	67
47387.....	21	48042.....	25	49400.....	33	49641.....	81	49858.....	67
47392.....	21	48043.....	25	49401.....	33	49642.....	81	49859.....	67
47393.....	21	48044.....	25	49402.....	33	49643.....	81	49860.....	67
47394.....	21	48045.....	25	49412.....	33	49646.....	81	49861.....	67
47396.....	21	48046.....	25	49429.....	33	49647.....	81	49862.....	67
47400.....	21	48047.....	25	49431.....	33	49649.....	81	49863.....	67
47404.....	21	48048.....	25	49434.....	33	49650.....	81	49864.....	67
47407.....	21	48049.....	25	49436.....	33	49651.....	81	49865.....	67
47412.....	21	48050.....	25	49449.....	33	49652.....	81	49866.....	67
47413.....	21	48051.....	25	49451.....	33	49654.....	81	49867.....	67
47414.....	21	48052.....	25	49454.....	33	49709.....	35	49868.....	67
47416.....	21	48053.....	25	49534.....	47	49712.....	35	49869.....	67
47420.....	21	48054.....	25	49542.....	47	49715.....	35	49876.....	59
47424.....	21	48055.....	25	49543.....	47	49729.....	35	49877.....	59
47427.....	21	48056.....	25	49544.....	47	49732.....	35	49878.....	59
47433.....	21	48057.....	25	49552.....	47	49735.....	35	49879.....	59
47580.....	55	48058.....	25	49553.....	47	49749.....	35	49880.....	59
47581.....	55	48059.....	25	49555.....	47	49752.....	35	49881.....	59
47582.....	55	48060.....	25	49560.....	47	49755.....	35	49882.....	59
47583.....	55	48070.....	27	49562.....	47	49757.....	35	49883.....	59
47584.....	55	48071.....	27	49563.....	47	49759.....	35	49884.....	59
47585.....	55	48072.....	27	49565.....	47	49801.....	49	49885.....	59
47586.....	55	48073.....	27	49566.....	47	49802.....	49	49887.....	59
47587.....	55	48074.....	27	49568.....	47	49803.....	49	49888.....	59
47588.....	55	48075.....	27	49569.....	47	49804.....	49	49889.....	59
47589.....	55	48076.....	27	49571.....	47	49805.....	49		
47590.....	55	48077.....	27	49572.....	47	49806.....	49		
47591.....	55	48078.....	27	49573.....	47	49807.....	49		
47592.....	55	48079.....	27	49574.....	47	49808.....	49		
47593.....	55	48080.....	27	49581.....	57	49809.....	49		
47594.....	55	48081.....	27	49582.....	57	49810.....	49		
47652.....	23	48082.....	27	49583.....	57	49811.....	49		
47653.....	23	48083.....	27	49584.....	57	49812.....	49		
47654.....	23	48084.....	27	49585.....	57	49816.....	63		
47656.....	23	48085.....	27	49586.....	57	49817.....	63		
47660.....	23	48086.....	27	49587.....	57	49818.....	63		
47664.....	23	48111.....	25	49588.....	57	49819.....	63		
47667.....	23	48112.....	25	49589.....	57	49820.....	63		

Salesnetwork

Around the world.

With our worldwide technical sales and service network we are close to our customers at all times. This ensures quick response, individual support and personal service – based everywhere on an understanding of local requirements..

Definition
from page 164

Technical Information
from page 178

Technical support:
Fon: +49 (0)2762 4003-0



Headquarter

TSUBAKI KABELSCHLEPP GmbH
Daimlerstraße 2
57482 Wenden-Gerlingen
Fon: +49 (0)2762 4003-0
Fax: +49 (0)2762 4003-220
info@kabelschlepp.de



Business Unit CAPS

KABELSCHLEPP GMBH-
HÜNSBORN
Wielandstraße 1 –
Industriegebiet Ost
D-57482 Wenden-Hünsborn
Fon: +49 (0)2762/9742-0
Fax: +49 (0)2762/9742-699
ksh@kabelschlepp.de

Automotive Division

KABELTRAX, A division of
TSUBAKI KABELSCHLEPP
Daimlerstraße 2
57482 Wenden-Gerlingen
Fon: +49 (0)2762 4003-300
Fax: +49 (0)2762 4003-40300
info@kabeltrax.de · kabeltrax.de

Our worldwide contact persons can be found at: tsubaki-kabelschlepp.com/salesnetwork

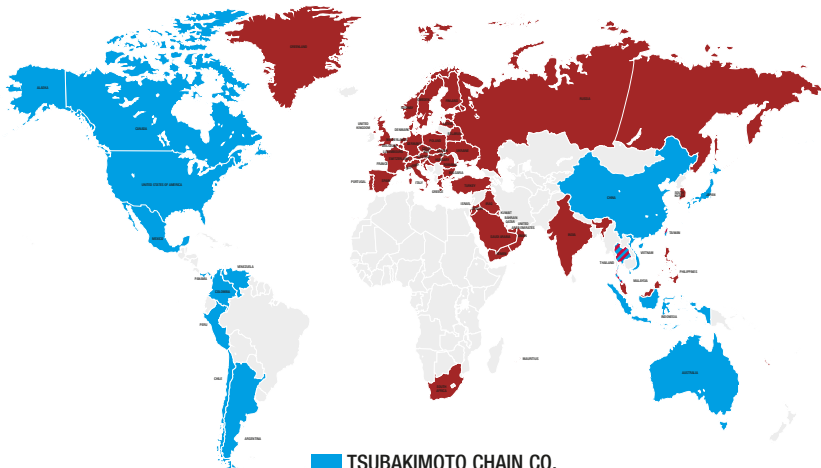

■ TSUBAKIMOTO CHAIN CO.

■ TSUBAKI KABELSCHLEPP GmbH

More information:
traxline.de

tsubaki-kabelschlepp.com

Technical support:
technik@kabelschlepp.de

Registered trademarks worldwide!

These trademarks are legally protected for the TSUBAKI KABELSCHLEPP GmbH as a national or international registration in the following countries:

CAPS®, **CLEANVEYOR**®, **CONDUFLEX**®, **EasyTrax**®, **FLATVEYOR**®, **KABELSCHLEPP**®, **KS**®, **NanoTrax**®, **PROFILE**®, **PROTUM**®, **QUANTUM**®, **QuickTrax**®, **ROBOTRAX**®, **TOTALTRAX**®, **TRAXLINE**®, **TSUBAKI KABELSCHLEPP**®



For further information please visit: tsubaki-kabelschlepp.com/Trademarks

CABLE CARRIER SYSTEMS

Cable carriers made of steel and plastic
QUANTUM® cable and hose carrier system
PROTUM® cable and hose carrier system
ROBOTRAX® cable and hose carrier system

TRAXLINE® CABLES FOR MOTION

Continuous bending hi-flex cables for cable carriers
TOTALTRAX® complete turn-key carrier systems
Assembled cables

GUIDEWAY PROTECTION SYSTEMS

Telescopic covers
Link apron covers
Way wipers
Conical spring covers
Bellows
Protective devices

CONVEYOR SYSTEMS

Hinged belt conveyors
Scraper conveyors
Belt conveyors

TSUBAKI KABELSCHLEPP GmbH

Daimlerstraße 2
D-57482 Wenden-Gerlingen
Fon: +49 (0)2762 4003-0
Fax: +49 (0)2762 4003-220
E-mail: info@kabelschlepp.de
tsubaki-kabelschlepp.com

TSUBAKI KABELSCHLEPP worldwide

For contacts, addresses and
much more, visit our website at
tsubaki-kabelschlepp.com

0760155

EN 06/2019